

The Log Periodic V Antenna

JUNE

Radio-Electronics

TELEVISION • SERVICING • HIGH FIDELITY

HUGO GERNSBACH, Editor-in-chief

50c



**Get the Best from
Ceramic Cartridges**

**Garage-Door Opener
Uses Tunnel Diode**

**How to
Scribble a Circuit**

**Silent Listening
For Your TV**

**Trans-Switch Doubles
Your Scope's Value**

**Build This
Base-Dip Oscillator**

See page 4 ▶

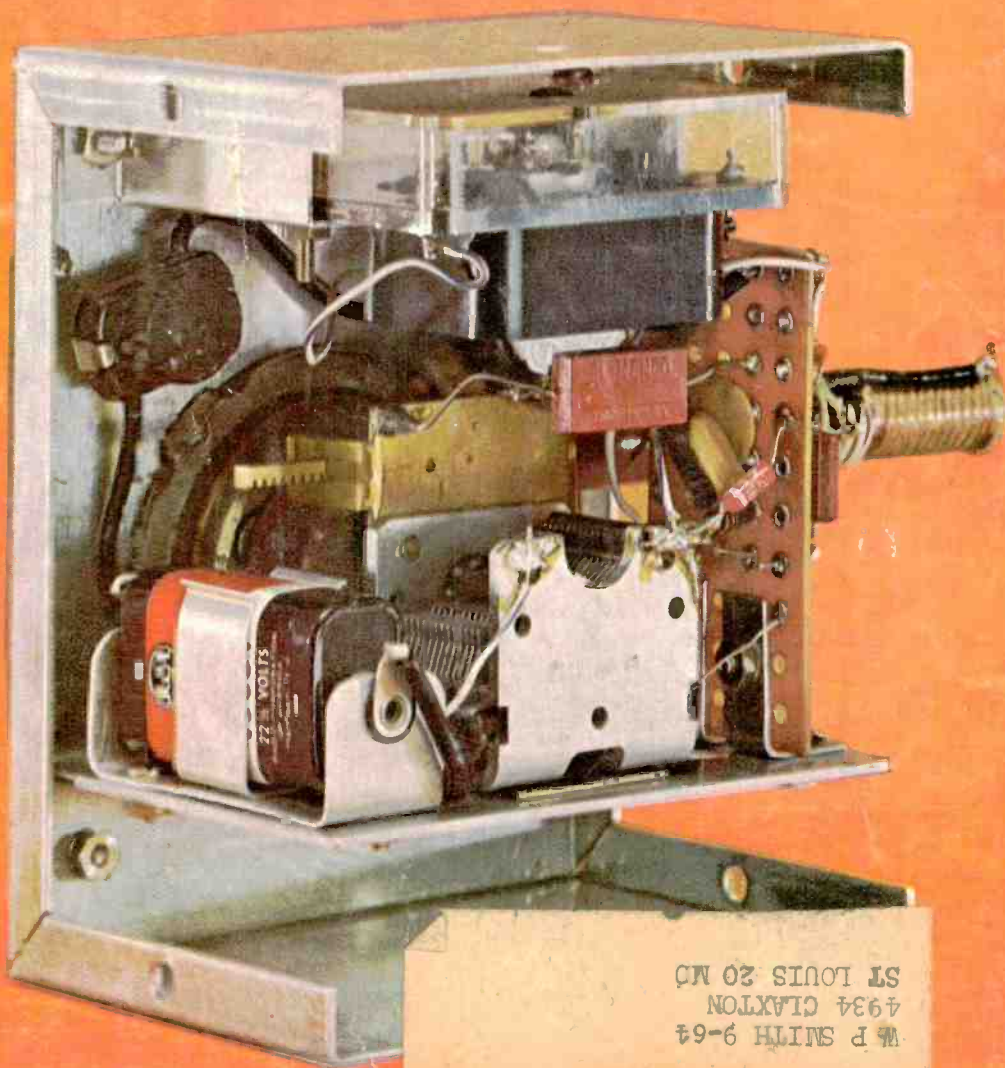

W. P. SMITH 9-64
4934 CLAXTON
ST LOUIS 20 MO

200,000 OHMS PER VOLT

NEW AND THE FIRST

\$99.50
SUGGESTED
U.S.A. USER NET



Model 630-NS
VOLT-OHM-MICROAMMETER

TRIPLET SUSPENSION MOVEMENT
*no pivots ... no jewels ...
no hair springs ... thus NO FRICTION.*

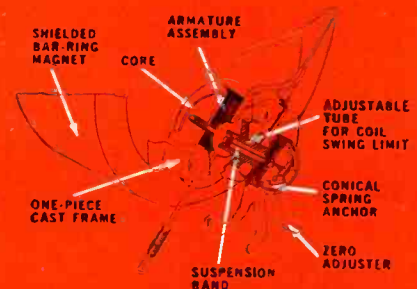

FACTS MAKE FEATURES

- 1** 200,000 OHMS PER VOLT D.C. for greater accuracy on high resistance circuits. 20,000 OHMS PER VOLT A.C.
- 2** $5\mu\text{a}$ SUSPENSION METER MOVEMENT. No pivots, bearings, hair-springs, or rolling friction. Extremely RUGGED. Greater sensitivity and repeatability.
- 3** 62 Ranges, usable with frequencies through 100 Kc. Temperature compensated. $1\frac{1}{2}\%$ D.C. ACCURACY, 3% A.C.

Low voltage ranges and high input impedance make the 630-NS especially useful in transistor circuit measurement and testing. Input impedance, at 55 volts D.C. and above, is *higher than most vacuum tube voltmeters.*

The unit is designed to withstand overloads and offers greater reading accuracy. Reads from $0.1\mu\text{a}$ on $5\mu\text{a}$ range. Special resistors are rigidly mounted and directly connected to the switch to form a simplified unit. Carrying cases with stands are priced from \$9.90.

TRIPLET ELECTRICAL INSTRUMENT COMPANY, BLUFFTON, OHIO

62 RANGES

D.C. VOLTS	0-0.6-3-12-60-300-1200 at 100,000 Ohms/Volt. 0-0.3-1.5-6-30-150-600 at 200,000 Ohms/Volt. 0-0.150 at $60\mu\text{a}$
A.C. VOLTS	0-3-12-60-300-1200 at 10,000 Ohms/Volt. 0-1.5-6-30-150-600 at 20,000 Ohms/Volt.
DB	-20 to 77 in 10 ranges.
D.C. MICRO-AMPERES	0-5 at 300 MV. 0-60-600 at 150 MV. 0-120 at 300 MV.
D.C. MILLI-AMPERES	0-6-60-600 at 150 MV. 0-1.2-12-120-1200 at 300 MV.
D.C. AMPERES	0-6 at 150 MV. 0-12 at 300 MV.
OHMS	0-1K-10K-100K (4.4-44-440 at center scale)
MEGOHMS	0-1-10-100 (4400-44,000-440,000 Ohms center scale)

OUTPUT: Condenser in series with A.C. Volt ranges.



630

630-A

630-PL

630-APL

630-NA

630-NS

630-T

631

310

310C

666-HH

800

666-R

THE WORLD'S MOST COMPLETE LINE OF V-O-M'S. AVAILABLE FROM YOUR TRIPLET DISTRIBUTOR'S STOCK

Now **NINE WAYS** to Train at Home For a Career in **ELECTRONICS**

1 INDUSTRIAL-MILITARY ELECTRONICS
Learn Principles, Practices, Maintenance of Electronic equipment used today in business, industry, defense. Covers Electronic controls and measurement, computers, servos, telemetry, multiplexing, many other subjects.

2 RADIO AND TELEVISION SERVICING
Learn to service and maintain AM-FM Radios, TV sets, Stereo Hi-fi, PA systems, etc. A profitable, interesting field for part-time or full-time business of your own.

3 FCC LICENSE
Prepares you quickly for First Class License exams. Every communications station must have one or more FCC-licensed operators. Also valuable for Service Technicians. You train at home.

4 COMPLETE COMMUNICATIONS
A comprehensive training course for men seeking careers operating and maintaining transmitting equipment in Radio-TV Broadcasting or mobile, marine, aviation communications. Prepares you for FCC License.

5 MOBILE COMMUNICATIONS
Training in installation and maintenance of mobile equipment and associated base stations like those used by fire and police, taxi companies, etc. Prepares you for First Class FCC License exams.

6 MARINE COMMUNICATIONS
Shipboard transmitting equipment, direction finders, depth indicators, radar are all covered in this course. You prepare for your First Class Radiotelephone License with Radar Endorsement.

7 AVIATION COMMUNICATIONS
For men who want careers working with and around planes. Covers direction finders, ranges, markers, loran, shoran, radar, landing systems, transmitters. Prepares you for FCC License exams.

8 MATH FOR ELECTRONICS
A short course package of five carefully prepared texts that take you from basic arithmetic review through graphs and electronic formulas. Quick, complete and low in cost.

9 BASIC ELECTRONICS
An abbreviated, 26-lesson course covering Automation-Electronics, Radio-Television language, components and principles. Ideal for salesmen, hobbyists and others who find it valuable to be familiar with the fundamentals of this fast-growing industry.

Pick Your Field and Train with the Leader **nri**



Perhaps you're working in Electronics now and feel the need for an FCC License or more math . . . perhaps you're a hobbyist trying to decide between a career in Automation or Communications . . . perhaps you're a beginner who left school early, but are thinking about the career possibilities of building a spare-time or full-time business of your own servicing radios and television sets. Worker, hobbyist or beginner . . . whatever your desire, there's

Electronics training for everyone among the nine specialized courses NRI now offers. You can choose "short courses," specialized training in fields of Communication or intensive training for career positions.

Special Equipment Included

Specializing in Electronics makes it possible for NRI to provide a variety of courses to fit the needs of most any ambitious man; courses built around NRI's time-proved "learn-by-practice" method that makes learning easier, faster, better. Most NRI courses include—at no extra cost—special training equipment to give shop and laboratory experience in your home. And all equipment is yours to keep. As the oldest and largest school of its kind,



NRI has nearly half a century of experience training tens of thousands of men of all ages and varying educations for successful careers in Electronics. Check the course of most interest to you and mail the coupon now. Find out about Electronics opportunities, NRI training, NRI trial plan, convenient terms. NRI TRAINING, Washington 16, D.C.

Mail Coupon TODAY

NRI Training

Washington 16, D.C.

3-FF

Please send me 64-page Catalog on training at home with NRI. I am interested in the course checked below. (No salesman will call.)

- | | |
|---|--|
| <input type="checkbox"/> Industrial Electronics | <input type="checkbox"/> Complete Communications |
| <input type="checkbox"/> Radio-TV Servicing | <input type="checkbox"/> Mobile Communications |
| <input type="checkbox"/> FCC License | <input type="checkbox"/> Marine Communications |
| <input type="checkbox"/> Math for Electronics | <input type="checkbox"/> Aviation Communications |
| <input type="checkbox"/> Basic Electronics | |

Name _____ Age _____

Address _____

City _____ Zone _____ State _____

The Amazing
Field of
Electronics



AMERICA'S OLDEST AND LARGEST TV-RADIO ELECTRONICS HOME-STUDY SCHOOL



Radio-Electronics

June 1963
VOL. XXXIV No. 6

Formerly RADIO CRAFT—Incorporating SHORT WAVE CRAFT—TELEVISION NEWS—RADIO & TELEVISION*

semi-annual index

72 Index for January—June 1963, inclusive

editorial

Hugo Gernsback 23 After the Computer, What?

audio-high fidelity-stereo

- Herman Burstein 28 Get the Best From Those Ceramic Cartridges
That can be quite a bit
- Robert F. Scott 40 Music All Over the House—Without Wires
*Details on the G-E HMDS and Westinghouse Mobil
Sound distribution systems*
- Jack Darr 62 Using Shielded Cables
- 70 Column Speaker Enclosure
Building a 36-inch, 5-speaker unit

electronics

- Rufus P. Turner 32 How to Scribble a Circuit
All you need is a pencil and paper
- Richard H. Dorf 39 Those Crazy Values
- 43 What's Your EQ?
- Dellroye D. Darling 48 What's Different About Industrial Electronics
Nothing that should throw a radio-TV technician

general

- 27 Blind Learn Electronics in Special School
- Glen F. Stillwell 31 Soldering Simplified
- Gordon E. Kaye 46 Which Dry Battery for You?
- 52 Electronics Teaching Aids

radio

- John F. Cleary and Erich Gottlieb 37 Tunnel-Diode Remote-Control Transmitter
Open your garage door with this rig
- Robert F. Scott 50 New Accessories Improve Citizens Band Operation
*Eliminate noise and transmission line losses at your
CB station*

television

- Edward Finkel 24 Log Periodic V
A new approach to broad-band TV antennas
- Sam Hamilton 42 Silent TV Listening
No sound from the TV but you can hear every word
- Jack Darr 53 Service Clinic Diagnosis
Logic in TV servicing

test instruments

- Robert F. Sanford 34 Base-Dip Oscillator (Cover Feature)
Continuous reading from 2.8 to 31 megacycles
- Dave Stone 44 Trans-Switch—Electronic Scope Switch
All-transistor unit increases the value of your scope
- 66 Cantenna Dummy Load and Transistor Dc Multimeter
Equipment Report: HN-31 and Motorola S1052B

the departments

43, 96 Corrections
18 Correspondence
101 New Books

95 New Literature
99 New Patents
78 New Products

96 New Semiconductors & Tubes
6 News Briefs
97 Noteworthy Circuits

90 Technicians' News
86 Technotes
93 Try This One

Over 55 Years
of Electronic Publishing

EDITOR-IN-CHIEF AND PUBLISHER
Hugo Gernsback

EDITOR

M. Harvey Gernsback

MANAGING EDITOR

Fred Shunaman

TECHNICAL EDITOR

Robert F. Scott, W2PWG

ASSOCIATE EDITOR

Peter E. Sutheim

EDITORIAL ASSOCIATE

I. Queen

EDITORIAL ASSISTANT

Ramona Goldman

SERVICE EDITOR

Jack Darr

TECH. ILLUSTRATION DIRECTOR

Wm. Lyon McLaughlin

ART ASSOCIATE

Fred Neinast

DIRECTOR OF PRODUCTION

Elizabeth Stalcup

DIRECTOR, ADVERTISING SALES

Frank T. Baker

EASTERN SALES MANAGER

John J. Lamson

CIRCULATION MANAGER

G. Aliquo

DIRECTOR, NEWSSTAND SALES

Joseph L. Bund

—on the cover—

(Story on page 34)

Exterior and interior views of a home-built base-dip oscillator. Its unique tuning system covers 2.8 to 31 mc with a single coil.

Color original by

Habershaw Studios

Gernsback Publications, Inc.

EXECUTIVE, EDITORIAL, ADVERTISING OFFICES

154 W. 14 St., New York 11, N.Y.
Telephone AL 5-7755

CHAIRMAN OF THE BOARD

Hugo Gernsback

PRESIDENT

M. Harvey Gernsback

SECRETARY

G. Aliquo



Radio-Electronics is indexed in
Applied Science & Technology Index
(Formerly Industrial Arts Index)

*Trademark registered U. S. Pat. Office

A NEW WORLD OF OPPORTUNITY AWAITS YOU WITH N.T.S. ALL-PHASE HOME TRAINING IN ELECTRONICS



You can install and maintain electronic circuitry in missiles and rockets ... specialize in micro-waves, radar and sonar.

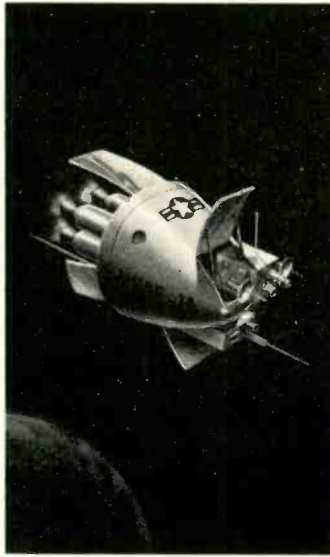

You can succeed in TV-Radio Communications ... prepare for F.C.C. License, service advanced satellites for industry and defense.



You can service and repair the electronic "brains" of industry — computers, data processing, and other automation equipment.

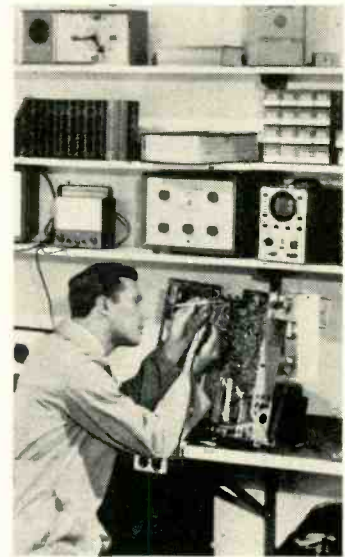

You can become a highly-paid TV-Radio Technician, an electronics field engineer, or succeed in your own sales & service business.

The N.T.S. Master Course enables you to do more, earn more in ELECTRONICS • TELEVISION • RADIO Yet N.T.S. Training costs no more than other courses far less complete

There's a good reason why N.T.S. Master-Training opens a wide new world of opportunity for you in Electronics, Television, Radio.

Everything you learn, from start to finish, can be applied directly to all phases of the Electronics Industry.

As a result, the N.T.S.-Trained Technician can move ahead faster, in any direction — from TV-Servicing to Radio Communications to Space-Missile Electronics and Automation for industry and defense. You can go wherever pay is highest and opportunity unlimited.

Electronic circuitry, for example, is one of science's miracles that is basic to the entire field of Electronics. It is used in satellites, computers and space capsules as well as in today's television sets and high fidelity equipment. N.T.S. shows you how to service and repair electronic circuitry for all electronic applications.

You work on many practical job projects. You build a short-wave, long-wave superhet receiver, plus a large-screen television set from the ground up. N.T.S. training kits contain all the parts you need ... at no extra cost. (See box at right.) You also receive a professional Multimeter to use during training and on the job.

ONE LOW TUITION. You need training related to all phases of Electronics. Industry demands it. Only N.T.S. provides it ... in ONE Master Course at ONE low tuition.

RESIDENT TRAINING AT LOS ANGELES

If you wish to take your Electronics-TV-Radio training in our famous Resident School in Los Angeles — the oldest and largest school of its kind in the world — write for special Resident School catalog and information, or check coupon.



NATIONAL TECHNICAL SCHOOLS

WORLD-WIDE TRAINING SINCE 1905
4000 So. Figueroa St., Los Angeles 37, Calif.



YOU ENROLL BY MAIL AND SAVE MONEY. No salesmen means lower costs for us, lower tuition for you.

START NOW. A whole new world of opportunity awaits the man with Electronic Home-Training from National Technical Schools — a recognized leader in technical training for 58 years.



19 BIG KITS
YOURS TO KEEP



MAIL COUPON NOW FOR FREE BOOK AND ACTUAL LESSON!

NO OBLIGATION.
NO SALESMAN WILL CALL.

NATIONAL TECHNICAL SCHOOLS

WORLD-WIDE TRAINING SINCE 1905

**National Technical Schools, Dept. RG-63
4000 S. Figueroa St., Los Angeles 37, Calif.**

Please Rush FREE Electronics-TV-Radio "Opportunity" Book and Actual Lesson. No Salesman Will Call.

Name _____ Age _____

Address _____

City _____ Zone _____ State _____

Check if interested ONLY in Resident Training at L.A.

High school home study courses also offered. Check for free catalog.

RADIO-ELECTRONICS published monthly at Concord, N. H., by Gernsback Publications Inc. Second-class postage paid at Concord, N. H. Copyright © 1963, by Gernsback Publications Inc. All rights reserved under Universal, International and Pan-American Copyright Conventions. **SUBSCRIPTION RATES:** US and possessions: Canada: \$5 for 1, \$9 for 2, \$12 for 3 years. Pan-American countries: \$6 for 1, \$11 for 2, \$15 for 3 years. Other countries: \$6.50 for 1, \$12 for 2, \$16.50 for 3 years. Postmaster send form 3579 to 154 W. 14th St., New York 11, N. Y.

News Briefs

Electronic Frog's Eye Is New Computer Device

An electronic "frog's eye" model may be the forerunner of a new generation of information processing devices, states Donald J. Parker, manager of RCA's Applied Research activities. The model consists of six panels of electronic circuitry, each 40 inches square and 4½ inches thick, representing the six layers of the frog's retina. It is the first computerlike device, states Parker, that abstracts features from its environment by parallel instead of serial processing. Former devices operated in the sequential, or scanning, method. The cells which make up the "frog's eye" are in parallel, and if some of them become inoperative, the effectiveness of the device is only slightly reduced. In a serial type device, the breakdown of one cell might well put the whole equipment out of action.

An important feature of the real frog's eye is that it screens out things not interesting to the frog before they reach the brain. He may see a fly moving toward him or a sudden shadow which might be a hawk swooping down toward him, but he never sees a fly moving away from him, and is not affected by a shadow caused by a cloud moving across the sun. These features could well be applied to certain machines, such as those designed to read radar

screens. They would be able to select only targets moving in a certain direction, for example.

Similarly, the frog's eye model abstracts the features from the scene before it, beginning with the 1,600 photocells on the first layer, which is a contrast detector, and screening them through the succeeding five layers, to display the final results on a panel of colored lights. Red lights show the edges the frog sees; green, the moving convexities or corners which the eye decided were going in the right direction at the right speed to bring to the frog's attention. Yellow lights show the leading and trailing edges of selected objects, and white lights display the effects of general dimming caused by things like a bird swooping down to gulp the frog.

Satellites May Track Animals

Tiny radios, attached to a goose's chest, a deer's neck or the wing of an albatross, tell scientists where the creatures migrate, describe their route, speed and altitude, tell how rapidly their wings beat and how fast they breathe on their way.

These transmitters have been used for several years, says Prof. Dwain W. Warner of the Museum of Natural History at the University of Minnesota. They weigh less than 1 ounce and do not disturb the animal.

But these studies, Professor Warner points out, must end when the scientist goes home for the night. Next year, if an animal satellite proposal now under government consideration is approved, the tracking system may work this way:

Six or more animals of a herd or flock starting to migrate would each be furnished with its own transmitter and power supply. The group would have its own radio frequency, and about every 103 minutes its signals would reach an 18,000-mile-per-hour satellite, in orbit over the North and South poles. Signals from the satellite will be relayed to a ground station and recorded on tape.

Twenty-four such receiving stations, says Professor Warner, could cover the earth, scanning 1,600 miles on each orbit and keeping round-the-clock vigil on animal travel.

New Color Tube?

A patent has been issued for a new type of beam-indexing color tube. It differs from Philco's "Apple" in that it uses X-rays as the index beam. The color strips appear to be laid down the same way as in the Philco Apple.

Patentee is David M. Goodman, senior research scientist at NYU Engineering Research Div. He claims that his tube can be produced at about half the price of the present shadow-mask tube for equal brightness and resolution, and that though receiver circuitry might be more expensive, costs would not be excessive and could be reduced rapidly with increased production.

TV Station Is All-Robot

WTEV Providence, on the air since January of this year, is fully

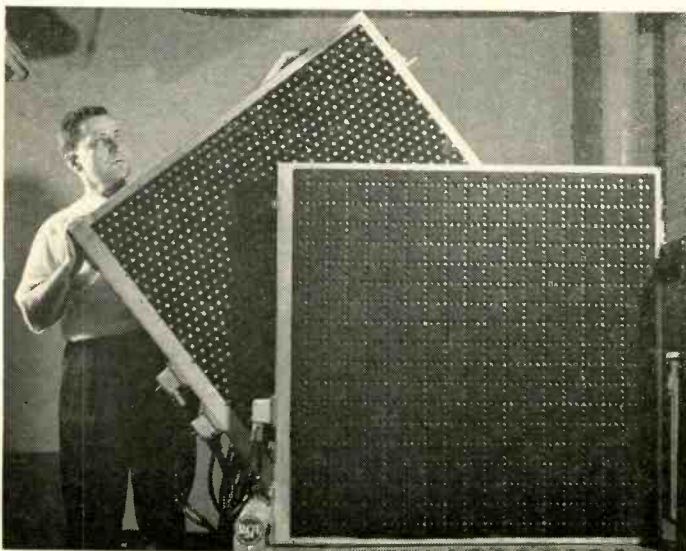

Two of the six layers of the electronic frog's retina.

Advertising Representatives: South—J. Sidney Crane & Associates, 22 8th St. N.E., Atlanta, Ga., Tel. TRinity 2-6720. Florida: Neff Associates, 15 Castle Harbor Isle, Fort Lauderdale, Fla., Tel. LOgan 6-5656. West—Husted-Coughlin, Inc., 1830 W. 8th St., Los Angeles, Calif., Tel. 389-3132. 444 Market St., San Francisco, Calif., Tel. GARfield 1-0151. **United Kingdom**—Publishing & Distributing Co., Ltd., Mitre House, 177 Regent St., London, W.1, England. **Subscription Service:** Address form 3579 and correspondence to Radio-Electronics, Subscriber Service, 154 West 14th St., New York 11, N. Y. When requesting a change of address please furnish an address label from a recent issue. Allow one month for change of address.

3

More Big Training Advantages



DeVRY Tech Exclusive!

WITH TRANSISTORIZED METER . . . PLUS NEW "MODULAR CIRCUITS" TO BUILD AT HOME!

Now Prepare for GOOD JOB OPPORTUNITIES IN ELECTRONICS Faster—with

- 1. METER**— Transistorized, Portable, AC-DC Multimeter
- 2. SCOPE**— 5-inch New Streamlined Commercial-Type Oscilloscope
- 3. ELECTRO-LAB***— For 3-Dimension Circuit Building

To help you get ready F-A-S-T-E-R . . . and THOROUGHLY . . . for good-paying job opportunities in the fast growing Electronics field, DeVry Technical Institute now presents the newest and finest training advantages in its over 30 years of experience. Now . . . AT HOME . . . in your spare time, you prepare with "industry-type" home laboratory equipment. To provide real PRACTICAL EXPERIENCE, you build a quality Transistorized Meter and a 5-inch industrial-type Oscilloscope . . . work with small, 3-dimensional circuits on DeVry's new Design Console . . . use highly instructive home training movies . . . and follow up-to-date lessons with many time-saving fold-out diagram sheets.

Little wonder DeVry men qualify for such fine opportunities in Space-Missile Electronics, Automation, Computer Work, Radio-TV, Industrial Controls, and other fields.

You learn PRACTICAL techniques important in today's Space Age industry, because you build many compact circuits with the streamlined Electro-Lab, using exclusive solderless "modular connectors." You perform over 300 construction and test procedures in all! Your self-built test equipment has function-grouped controls, meter scales color-keyed to the panel markings—much like instruments used on today's jobs. What's so important, the home laboratory and the test equipment are YOURS TO KEEP!



OSCILLOSCOPE

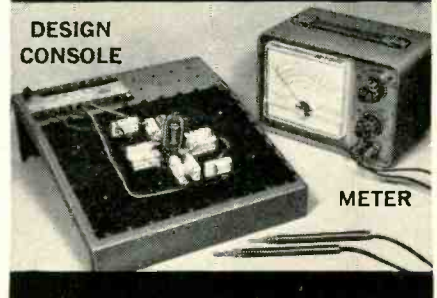

DESIGN CONSOLE

METER

* Trademark ©

INDUSTRY NEEDS TRAINED MEN

Through this remarkable 3-way method, DeVry Tech has helped thousands of ambitious men prepare for good jobs or their own profitable full-time or part-time service shops. It is the newest in a long series of PRACTICAL training aids that we have pioneered and developed in more than three decades of experience. Sound interesting? Then see how DeVry Tech may help YOU. Mail the coupon today.

From RADIO to SPACE-MISSILE ELECTRONICS

DeVry's training goes all the way from radio repair . . . to space-missile electronics. That's the range of subjects covered in its programs AT HOME or in its well-equipped training centers in Chicago and Toronto. You learn up-to-date techniques, working with new equipment, modern texts, movies—one of today's finest combinations of training equipment . . . geared for RESULTS!

EMPLOYMENT SERVICE

When you complete the program, DeVry's efficient Employment Service is ready to help you get started. There is no extra charge—ever—for this aid. ACCREDITED MEMBER, NATIONAL HOME STUDY COUNCIL

DeVRY TECHNICAL INSTITUTE
CHICAGO • TORONTO

MAIL COUPON FOR FREE FACTS

DEVRY TECHNICAL INSTITUTE 2082
4141 Belmont Ave., Chicago 41, Ill., Dept. RE-6-T

Please give me your two free booklets, "Pocket Guide to Real Earnings" and "Electronics in Space Travel"; also include details on how to prepare for a career in Electronics. I am interested in the following opportunity fields (check one or more):

- | | |
|--|---|
| <input type="checkbox"/> Space & Missile Electronics | <input type="checkbox"/> Communications |
| <input type="checkbox"/> Television and Radio | <input type="checkbox"/> Computers |
| <input type="checkbox"/> Microwaves | <input type="checkbox"/> Broadcasting |
| <input type="checkbox"/> Radar | <input type="checkbox"/> Industrial Electronics |
| <input type="checkbox"/> Automation Electronics | |

Name _____ Age _____

Address _____ Apt. _____

City _____ Zone _____ State _____

Check here if you face military service.

Canadian residents: Write DeVry Tech of Canada, Ltd.
970 Lawrence Avenue West, Toronto 19, Ontario

Available from all authorized ARCO distributors



Arcolytic®

1401 Values...The largest selection of exact replacement twist-mount & tubular electrolytics

■ 99.99% high purity aluminum foil electrolytics at no extra cost! ■ Choose from stock any single, dual, triple or quadruple capacitance - voltage combination for replacement in television, radio, and other electronic equipment ■ Made to withstand high ripple and high surge voltages ■ Designed for 85°C high temperature operation ■ Greater shelf and operating life because only premium grade ingredients are used ■ Built and tested to meet EIA Specification RS-154 ■ Individually packaged with mounting plates for your convenience ■ Unconditionally Guaranteed.

ARCO ELECTROLYTIC DIVISION
electronics inc. Branches:
Dallas 7
Los Angeles 35
Community Drive, Great Neck, New York • HUnter 7-0500

automated from sign-on to sign-off. Its complete program schedule is punched into IBM cards. The Visual 6000 Automation System reads the cards and controls all video switching, prerolls projectors and video tape recorders, operates multiplexers, changes slides, switches or mixes audio, starts audio cartridges and mutes speaker.

Mr. Mann Reed, WTEV's operations manager and organizer of the system, described its functions at a seminar held by Visual Electronics in Chicago April 4.

IEEE Convention Meets

The first IEEE International Convention, held in New York City during the last week of March, was attended by 70,432 engineers and scientists from more than 40 countries.

The convention was actually a continuation of the former IRE Annual Convention, since the AIEE (American Institute of Electrical Engineers) had held their annual winter meeting in January. Next year's convention will be a truly combined effort of the two organizations.

Subjects presented in 250 papers at 54 sessions ranged from a selection of communications frequencies for use on the moon to the use of ultrasonics in diagnosing heart trouble.

Probably the chief subject was the comparatively new laser, to which a special evening panel session was devoted. Computers and computer science ran it a close second, while communications, once practically the only subject discussed at the annual conventions, was dealt with in a few scattered sessions.

Electro-optical amplifier

A new transistorlike device, in which signals are carried by light from the input to the output circuit, was revealed by International Business Machines Corp.

The new optical transistor is made of gallium arsenide. Some of the energy of the incoming electric signal is converted into light, passing through the base, or middle section, of the device to the collector, where the light is absorbed and frees electrons which go into the external circuit as output current. The gallium arsenide of which the base is composed is translucent to light of the frequency developed in this device.

The advantage of the optical transistor is that light moves much faster than electric charges to the base. For high-frequency operation
(Continued on page 12)

RADIO-ELECTRONICS

Now is the time to come to the aid of your ^{outdoor} party!

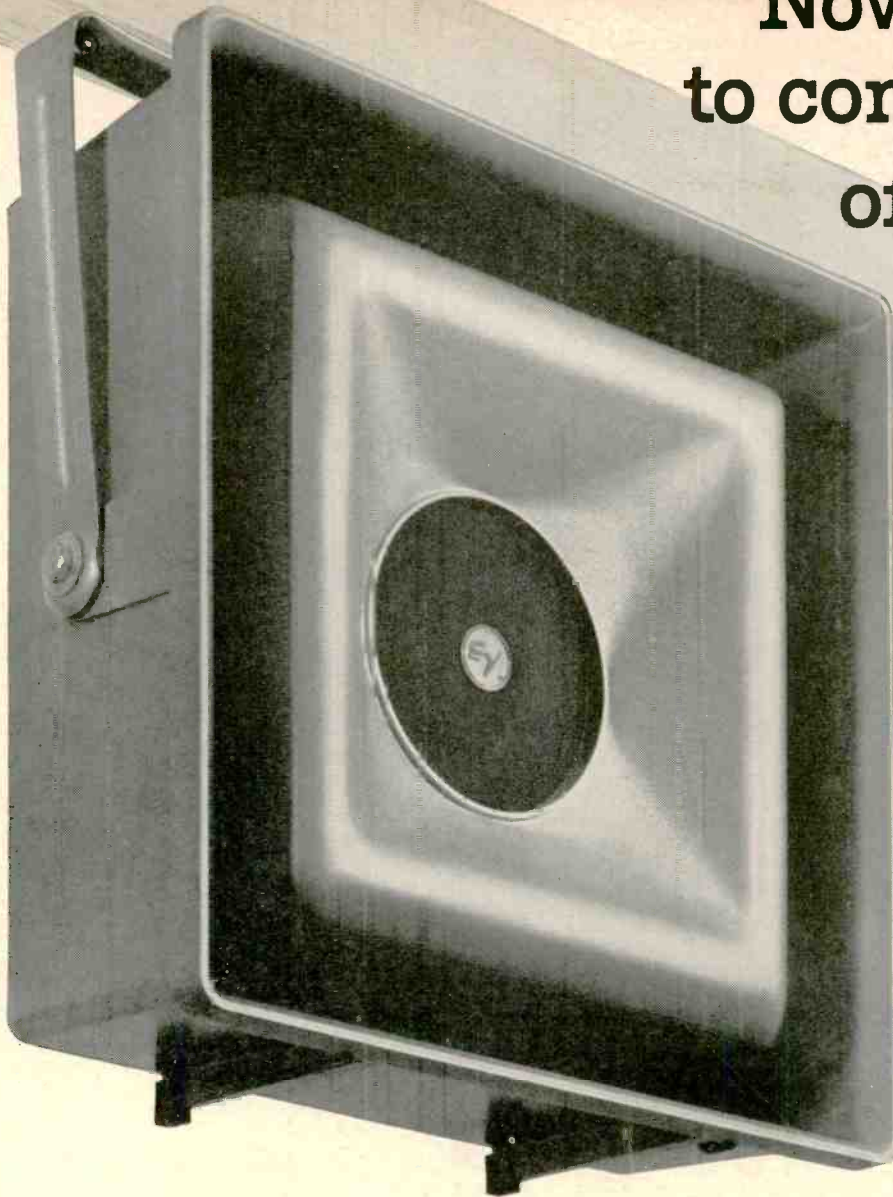

The more you enjoy outdoor living, the more you'll enjoy the Electro-Voice Musicaster—world's finest weather-proof loudspeaker-system.

A Musicaster will add to your fun wherever you are. Whether you're dancing under the stars, swimming in the pool, or relaxing around the barbecue in the backyard, music from a Musicaster adds the pleasure of outdoor high-fidelity music from your present Hi-Fi system, radio, phonograph or TV set.

It's easy to connect for permanent use outside, or you can simply move your Musicaster into the recreation room for year-'round pleasure.

Designed for indoor-outdoor use, the E-V Musicaster obtains high-fidelity response from a heavy-duty weather-proofed speaker mounted in a rugged aluminum die-cast enclosure. This combination insures long-lasting satisfaction under all conditions.

Now is the time to come to the aid of your outdoor party . . . with an Electro-Voice Musicaster. It's easy to install . . . send for full information and the name of your nearest E-V sound specialist.

ELECTRO-VOICE High-Fidelity Speaker System . . . it's Weather-proofed!

P.S. If your school, church or club needs a tough, high-quality, all-purpose speaker, the smart choice is an Electro-Voice Musicaster.

SPECIFICATIONS:

Frequency Response: 60-13,000 cps
Dispersion: 120°
Power Handling Capacity: 30 watts program
Impedance: 8 ohms
Size: 21½" H x 21½" W x 8½" D
Weight: 31 lbs. net
Price: \$54.00

Musicaster II available with additional tweeter to extend response to 18,000 cps. Price: \$75.00

Electro-Voice, Inc. Dept. 634E
Buchanan, Michigan
Please send me your booklet, "How to Enjoy High-Fidelity Outdoors."

Name _____
Address _____
City _____ State _____

ElectroVoice®

ELECTRO-VOICE, INC., Consumer Products Division, Buchanan, Michigan

BIG-SYSTEM MUSCLE...

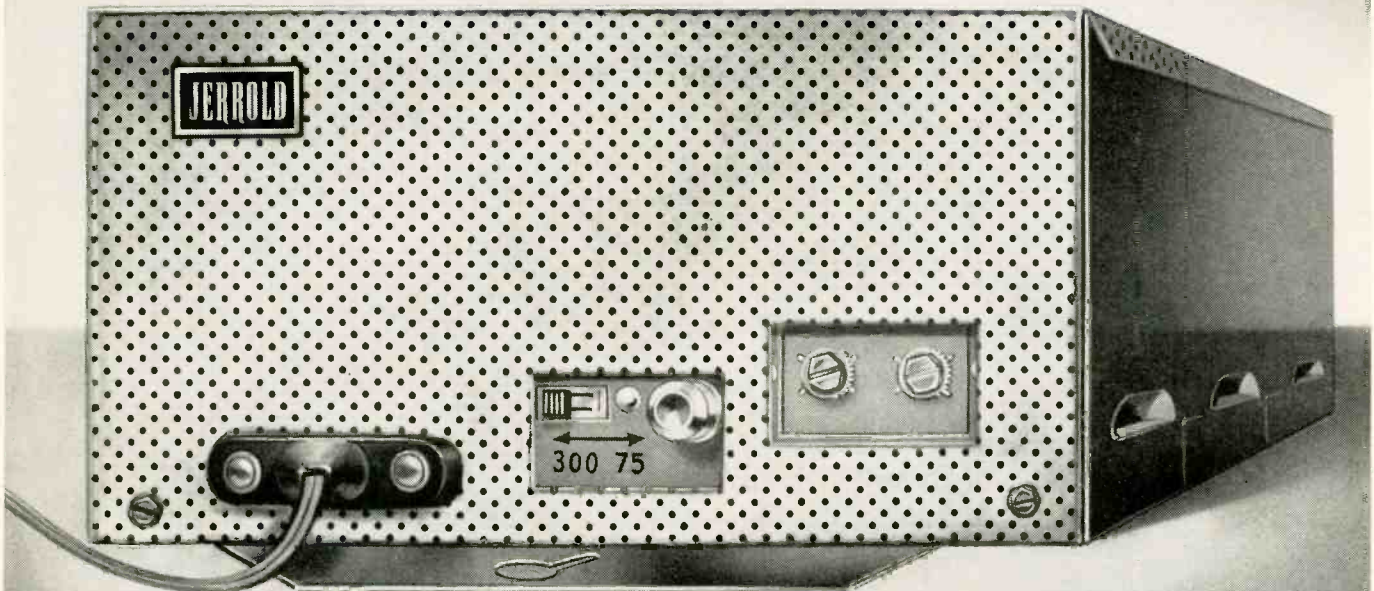

SMALL-SYSTEM PRICE!

NEW JERROLD *Challenger* TV DISTRIBUTION SYSTEM

ENGINEERED FOR THE NEW COLOR-TV ERA

- Designed for TV shops, dealers' showrooms, small apartments and motels
- Feeds up to 32 TV and FM sets
- No controls or adjustments
- New "Quick-Disconnect" plug-in outlets

Here's the distribution system to sell to TV and FM dealers for their color-TV showrooms... perfect too for the small apartment building or motel that's been needing an antenna system but couldn't afford one before. It's also ideal for your own service shop.

The JERROLD "Challenger" Amplifier, Model ACL-200, delivers 20db minimum gain over the low band, 19db over the high band. Flat response—unique in a low-price amplifier, but necessary for good color TV. Easy to install, no controls to adjust. Famous JERROLD quality is built in to stay.

Model ACL-200, \$38.97 net

See your JERROLD distributor or write Jerrold Electronics, Distributor Sales Division, Philadelphia 32, Pa.



New 4- and 8-way high-isolation networks.



New crown-washer screw terminals for stripped or unstripped twin lead.

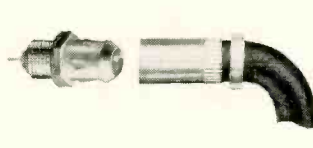

Exclusive "Gamma" chassis fittings for quick disconnect of any set.



A subsidiary of THE JERROLD CORPORATION

What Job Do You Want In Electronics?

Whatever it is, Cleveland Institute can help you get it!

Yes, whatever your goal is in Electronics, there's a Cleveland Institute program to help you reach it *quickly* and *economically*. Here's how: Each CIE program concentrates on electronics theory as applied to the solution of practical, everyday problems. Result . . . as a Cleveland Institute student you will not only learn electronics but *develop the ability to*

use it! This ability makes you eligible for any of the thousands of challenging, high-paying jobs in Electronics. Before you turn this page, select a program to suit your career objective. Then, mark your selection on the coupon below and mail it to us *today*. We will send you the complete details . . . without obligation . . . if you will act **NOW!**

Electronics Technology



A comprehensive program covering Automation, Communications, Computers, Industrial Controls, Television, Transistors, and preparation for a 1st Class FCC License.

First Class FCC License

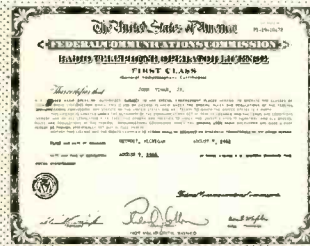

If you want a 1st Class FCC ticket quickly, this streamlined program will do the trick and enable you to maintain and service all types of transmitting equipment.

Industrial Electronics & Automation



This exciting program includes many important subjects as Computers, Electronic Heating and Welding, Industrial Controls, Servomechanisms, and Solid State Devices.

Electronic Communications

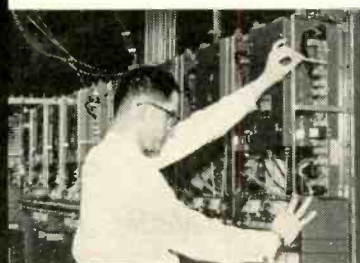

Mobile Radio, Microwave, and 2nd Class FCC preparation are just a few of the topics covered in this "compact" program . . . Carrier Telephony too, if you so desire.

Broadcast Engineering



Here's an excellent studio engineering program which will get you a 1st Class FCC License and teach you all about Program Transmission and Broadcast Transmitters.

Mail Coupon TODAY For FREE Catalog

Cleveland Institute of Electronics

1776 E. 17th St., Dept. RE-80
Cleveland 14, Ohio

Please send **FREE** Career Information prepared to help me get ahead in Electronics, without further obligation.

How to Succeed in Electronics

CHECK AREA OF MOST INTEREST—

- | | |
|---|--|
| <input type="checkbox"/> Electronics Technology | <input type="checkbox"/> First Class FCC License |
| <input type="checkbox"/> Industrial Electronics | <input type="checkbox"/> Electronic Communications |
| <input type="checkbox"/> Broadcast Engineering | <input type="checkbox"/> _____ other |

Your present occupation _____

Name _____ (please print) Age _____

Address _____

City _____ Zone _____ State _____

Approved for Veteran's Training under Korean GI Bill. RE-80

Cleveland Institute of Electronics

1776 E. 17th St., Dept. RE-80
Cleveland 14, Ohio



Accredited Member

*The wind blows just as hard
over your rooftop as it does
over the police station...*

The exceptional popularity of our Magnum 27 Citizens Band Base Antenna is due in part to its towering resistance to the elements. Nothing short of a tornado will damage it or impair performance. Here's why:

The "Maggie" is mechanically identical to our ASP-350 Professional Base Antenna — designed specifically, and field-proven in thousands of effective installations, to meet the super-critical requirements of police, fire departments and essential industrial users of two-way radio.

Same rugged, heavy-walled aluminum tubing, with telescope-interlock feature for instant assembly and no bending . . . same quality solid aluminum radials . . . same accurate, hand-finished workmanship throughout.

"Maggie" matches its professional twin in performance, too. End-fed, 1/2 wavelength. Through exceptional improvement of signal-to-noise ratio, operating gain is 6 db. over any single element omnidirectional CB antenna made. Very low noise. Signal pattern is intensified greatly by low radiating angle.

We've told you what we know. Your friends with the biggest signals on the air can tell you better. So can your CB dealer — see him soon.

M-81 MAGNUM CB base antenna

The finest brand for every band!

the
antenna
specialists
company

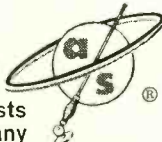

12435 Euclid Avenue, Cleveland 6, Ohio
Exp. Div. 15 Moore St., New York 4, N.Y.



"Stripes of Quality"

*P.S.
Your "Maggie" won't fail
in a gale -- but your
electric power might!*

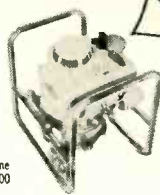

New "ZEUS" portable power generator with only one moving part. Alternator principle. 1000, 1250 and 3000 watt models. Write for complete information.

(Continued from page 8)

in a conventional transistor, the base must be made extremely thin, to shorten the time required for the passage of electric charges. These extremely thin base regions are hard to construct. In the optical transistor, they can be very much bigger.

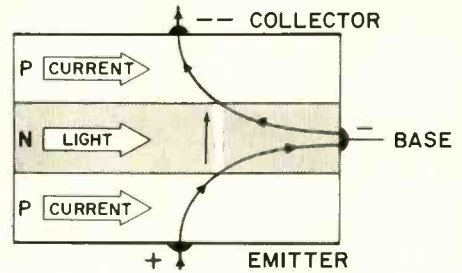

The new optical transistor. Electric current enters the device at the emitter. In the region of the junction between emitter and base, light is emitted due to recombination of electrons and holes. The light passes across the base region and creates electron-hole combinations as it is absorbed near the junction between base and collector. As shown, the base is biased negative with respect to the emitter, and the collector is negative to the base.

The experimental device is the work of Richard F. Rutz of IBM's Thomas J. Watson Research Center. Units made so far have a low current gain, but show a power gain as high as 50 at liquid nitrogen temperatures.

Color Going Up, Say Set Makers

Color TV set sales will climb to about 2.5 million by 1967, say 14 leading TV set and tube makers, while black-and-white sales sink to 4 million by '68.

The manufacturers were interviewed by Lionel D. Edie & Co., surveying for an unnamed firm. Detailed findings may not be made public.

Total TV sales, the study predicts, will stay in the 7-million range for about 5 years, with color's share of the sales growing steadily.

Governments Study ESP

Extrasensory perception, or telepathic communication, is the subject of serious study by both the United States and the Russian governments, states Nilo Lindgren in the magazine *Electronics*. The Air Force Cambridge Research Laboratories, he says, have been quietly conducting scientific experiments in ESP at their Communications Sciences Laboratory at Hanscom Field. The project even has

COMING NEXT MONTH IN RADIO-ELECTRONICS

SPEED COLOR SETUP AND SERVICE -- A color TV can be set up in 20 minutes.

BETTER ANTENNAS FOR SHORT-WAVE DX -- Verticals are best and easiest to build.

LEAKAGE CHECKER FOR YOUR VTVM -- It can be added with an hour's work.

NEW TRICKS WITH DIODES -- 2-way amplifiers to speech scramblers.

JULY ISSUE (on sale June 18)



Enter General Electric's ONE-O-ONE Contest. 101 prizes given every month... \$10 to \$100 with a Grand Prize of \$500 in cash. See your General Electric tube distributor for complete rules and official entry blank.

Get this book **FREE** with the purchase of G-E tubes. Here's *101 Tele-Clues* to help make TV repair easier and more profit-



able for you. Your General Electric tube distributor will give it to you free in appreciation of your purchase of G-E tubes and electronic equipment. Enter the ONE-O-ONE Contest. Get *101 Tele-Clues*. See your General Electric Distributor today.

Progress Is Our Most Important Product

GENERAL  ELECTRIC

Another Accent on Value from G-E *ELECTRONICS* Distributors

Harman-Kardon Shatters Old Concepts of Economy-Class Public Address Amplifiers!



COMMANDER CA-12

New performance and versatility standards with the "CA" SERIES COMMANDER

Unprecedented! 5 New Commanders . . . every one with **CERTIFIED POWER RATING!** Now you can plan a job accurately, get the results you expect!



COMMANDER CA-23

Versatile! Inputs for High and Low Impedance Mics—with on-chassis socket for plug-in mic matching transformer! Every quality or cable length requirement is now satisfied!

Expandable! Add Mic Channels as Needed! Space provided on medium and high power models for two additional mic channels. Up to four mic inputs now possible.

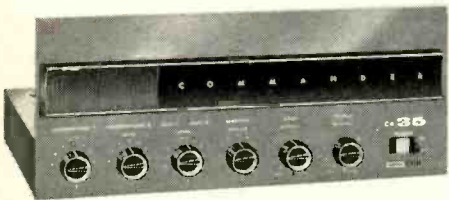

COMMANDER CA-35

Fidelity! Socket for an optional plug-in mag phono-tape head preamp with genuine built-in RIAA and NARTB equalization. Works in aux channel; avoids loss of a mic input.

Adaptability! Every Commander can be set up for precedence operation, essential for background music systems, special and emergency announcements, etc. CA-12 has MIX-MUSIC-PAGE switch; all others function automatically.

Flexible! Optional area speaker selector assembly installs in CA-35/65/100 to provide selective paging and musicasting to any or all of 8 areas.



COMMANDER CA-65
with extra mic pre-amp installed

It's impossible . . . to add here the numerous other MAJOR features of this remarkable new economy class public address line. But, a big new free catalog tells you the whole story about Commander and provides valuable, revealing information about public address amplifiers generally . . . Send for it.



COMMANDER CA-100
with extra mic channels and
area selector switch assembly

its own specialized equipment—a computerlike device called *Veritac*. The Russians, he says, have worked for years on what they call "biological radio communications." In laboratories in Moscow, Leningrad and Omsk, Russian scientists are said to have discovered that ESP is a form of electromagnetic radiation on a series of wavelengths in the centimeter, millimeter and shorter wavelengths. All these frequencies share in carrying the single messages, possibly something in the manner of our coded RACEP system.

CALENDAR OF EVENTS

5th National Radio Frequency Interference Symposium, June 4-5: Bellevue-Stratford Hotel, Philadelphia.

National Electronic Packing and Production Conference (NEP/CON), June 4-6: New York Coliseum, New York City.

1963 Chicago Spring Conference on Broadcast and TV Receivers, June 17-18: O'Hare Inn, Chicago.

EIA Annual Convention, June 18-20: Pick-Congress Hotel, Chicago.

International Symposium on Antennas and Propagation, July 9-11: Central Radio Propagation Lab, National Bureau of Standards, Boulder, Colo.

Publisher Passes

Milton Sleeper, pioneer in radio publications, died Jan. 31. Sleeper was one of the earliest in the field. He started his career, as did many others, on one of Gernsback's publications—*Electrical Experimenter*—in that magazine's early years. Later, he wrote books on radio and started the publication *FM*, which for many years was the only FM magazine in the field.

With the beginnings of interest in better music, he founded the magazine *High Fidelity*, later selling it and starting a second magazine, *High Fidelity Music in the Home*, which after a short existence was also sold.

He is survived by his wife, Mrs. Ethel Sleeper.

One-Station FM

In the last 8 months, 35,000 Americans have bought FM radios without knobs or dials. The sets don't need any, because they receive only one station.

Auditron Corp., a New York firm under the direction of radio veteran Emmet Poons, sells the sets through FM stations by mail order. Special uses include weather radios for steamship and tugboat use, and medical broadcasts for doctors, with waiting-room music for office hours!

Forward Air Control In 37-Lb Command Pack

A parachutist-carried command pack, weighing only 37 lb and including four separate two-channel transceivers, was demonstrated by Sylvania. The total size of the pack is 11 x 16 x 10 inches.

Harman-Kardon, Inc. Desk RE-6
Commercial Sound Div.
55 Ames Court, Plainview, L.I., N.Y.

Rush me the new p/a catalog that tells me the things I ought to know about public address amplifiers.

Name _____
Address _____
City _____ State _____

harman kardon

A subsidiary of THE JERROLD CORPORATION



What Does F. C. C. Mean To You?

What is the F. C. C. ?

F. C. C. stands for Federal Communications Commission. This is an agency of the Federal Government, created by Congress to regulate all wire and radio communication and radio and television broadcasting in the United States.

What is an F. C. C. Operator License ?

The F. C. C. requires that only qualified persons be allowed to install, maintain, and operate electronic communications equipment, including radio and television broadcast transmitters. To determine who is qualified to take on such responsibility, the F. C. C. gives technical examinations. Operator licenses are awarded to those who pass these examinations. There are different types and classes of operator licenses, based on the type and difficulty of the examination passed.

What are the Different Types of Operator Licenses ?

The F. C. C. grants three different types (or groups) of operator licenses — commercial radiotelePHONE, commercial radioteleGRAPH, and amateur.

COMMERCIAL RADIOTELEPHONE operator licenses are those required of technicians and engineers responsible for the proper operation of electronic equipment involved in the transmission of voice, music, or pictures. For example, a person who installs or maintains two-way mobile radio systems or radio and television broadcast equipment must hold a radiotelePHONE license. (A knowledge of Morse code is NOT required to obtain such a license.)

COMMERCIAL RADIOTELEGRAPH operator licenses are those required of the operators and maintenance men working with communications equipment which involves the use of Morse code. For example, a radio operator on board a merchant ship must hold a radioteleGRAPH license. (The ability to send and receive Morse is required to obtain such a license.)

AMATEUR operator licenses are those required of radio "hams"—people who are radio hobbyists and experimenters. (A knowledge of Morse code is necessary to be a "ham".)

What are the Different Classes of RadiotelePHONE Licenses ?

Each type (or group) of licenses is divided into different classes. There are three classes of radiotelePHONE licenses, as follows:

(1) Third Class RadiotelePHONE License. No previous license or on-the-job experience is required to qualify for the examination for this license. The examination consists of F. C. C. Elements I and II covering radio laws, F. C. C. regulations, and basic operating practices.

(2) Second Class RadiotelePHONE License. No on-the-job experience is required for this examination. However, the applicant must have

already passed examination Elements I and II. The second class radiotelePHONE examination consists of F. C. C. Element III. It is mostly technical and covers basic radiotelePHONE theory (including electrical calculations), vacuum tubes, transistors, amplifiers, oscillators, power supplies, amplitude modulation, frequency modulation, measuring instruments, transmitters, receivers, antennas and transmission lines, etc.

(3) First Class RadiotelePHONE License. No on-the-job experience is required to qualify for this examination. However, the applicant must have already passed examination Elements I, II, and III. (If the applicant wishes, he may take all four elements at the same sitting, but this is not the general practice.) The first class radiotelePHONE examination consists of F. C. C. Element IV. It is mostly technical covering advanced radiotelePHONE theory and basic television theory. This examination covers generally the same subject matter as the second class examination, but the questions are more difficult and involve more mathematics.

Which License Qualifies for Which Jobs ?

The THIRD CLASS radiotelePHONE license is of value primarily in that it qualifies you to take the second class examination. The scope of authority covered by a third class license is extremely limited.

The SECOND CLASS radiotelePHONE license qualifies you to install, maintain, and operate most all radiotelePHONE equipment except commercial broadcast station equipment.

The FIRST CLASS radiotelePHONE license qualifies you to install, maintain, and operate every type of radiotelePHONE equipment (except amateur, of course) including all radio and television stations in the United States, and in its Territories and Possessions. This is the highest class of radiotelePHONE license available.

How Long Does it Take to Prepare for F. C. C. Exams ?

The time required to prepare for F. C. C. examinations naturally varies with the individual, depending on his background and aptitude. Grantham training prepares the student to pass F. C. C. exams in a minimum of time.

In the Grantham correspondence course, the average beginner should prepare for his second class radiotelePHONE license after from 300 to 350 hours of study. This same student should then prepare for his first class license in approximately 75 additional hours of study.

Grantham offers exactly the same course in resident (classroom) training in four major cities in the United States. This is one of the +-'s of the Grantham training program. Home study students may, for any reason, transfer to classroom training simply by paying the balance of their home study tuition; they may then apply this entire amount to the resident class of their choice.

In the Grantham resident course, you prepare for your first class F. C. C. license in 8 weeks, 12 weeks, 20 weeks, or 30 weeks, depending on which class schedule you select.

What is the Grantham Approach ?

In electronics the same basic principles apply regardless of one's specialization within the field. But, in teaching electronics, relating these basic principles to a specific application gives the subject a frame of reference and makes it easier for the student to learn. To have you memorize Ohm's or Kirchhoff's laws, for example, without relating them to specific applications would be like learning a language phonetically without being able to understand or speak it. The Grantham course, therefore, teaches you basic electronics as it relates to the field of communications.

Why Choose Grantham Training ?

In the short time necessary to complete the course, you will acquire a knowledge of electronics — of the laws and theories of electronics, and their applications to the operation of practical equipment. These "basics" are presented in a logical, step-by-step manner, with the necessary math integrated into the course, from the viewpoint that you have no prior knowledge of the subject. In fact, everything in the course is presented from this viewpoint — nothing is taken for granted where your education is concerned. Thus, as a Grantham graduate, you are prepared to begin working at the technical level in any phase of electronics.

Should You Memorize or Understand ?

If you believe that electronics can be learned through memorizing by rote, our course is not for you. But, if you want to be able to think and reason electronics, we believe no other home study school offers so much knowledge and service in relation to time and money expended as Grantham does.

Is Grantham Training Accredited ?

Grantham School of Electronics is accredited by the Accrediting Commission of the National Home Study Council. The Accrediting Commission has been approved by the U.S. Office of Education as a "nationally recognized accrediting agency" under the terms of Public Laws 82-550 and 85-864.

Two "Door-Openers" to Employment

(1) First Class Commercial F. C. C. License: The Grantham course prepares you to pass the examination for this license, which is actually a "diploma" issued by the U.S. Government to certify qualified electronics technicians. It assures a prospective electronics employer that you are a man with the necessary knowledge to "build" with his company.

(2) Pre-Employment Exams Given By Industry: You are qualified to make an excellent showing on the exams which many industrial electronics firms require of a potential employee.

For further details concerning F.C.C. licenses and our training, send for our FREE booklet, "Careers in Electronics". Clip the coupon below and mail it to the School.

Get your First Class Commercial F. C. C. License Quickly by training at



GRANTHAM
SCHOOL OF ELECTRONICS

1505 N. Western Ave.
Los Angeles 27, Calif.
(Phone: HO 7-7727)

408 Marion Street
Seattle 4, Wash.
(Phone: MA 2-7227)

3123 Gillham Road
Kansas City 9, Mo.
(Phone: JE 1-6320)

821 - 19th Street, N.W.
Washington 6, D. C.
(Phone: ST 3-3614)



(Mail in envelope or paste on postal card)

To: GRANTHAM SCHOOL OF ELECTRONICS
NATIONAL HEADQUARTERS OFFICE
1505 N. Western Ave., Hollywood 27, Calif.

Gentlemen:

Please send me your free booklet telling how I can get my commercial F.C.C. license quickly. I understand there is no obligation and no salesman will call.

Name _____ Age _____

Address _____

City _____ State _____

I am interested in:

Home Study, Resident Classes 34-G

MAIL COUPON NOW—NO SALESMAN WILL CALL →

JUNE, 1963

15

ATR PRODUCTS FOR MODERN LIVING



ATR PLUG-IN TYPE PORTABLE INVERTERS*

A.C. HOUSEHOLD ELECTRICITY Anywhere . . . in your own car, boat or plane Operates Standard A.C.

- Record Players
- Dictating Machines
- Small Radios
- Electric Shavers
- Heating Pads, etc.

MODELS
 6-RMF (6 volts) 60 to 80 watts. Shipping weight 12 lbs. DEALER NET PRICE \$33.00
 12T-RME (12 volts) 90 to 125 watts. Shipping weight 12 lbs. DEALER NET PRICE \$33.00
 *Additional Models Available

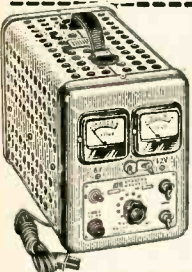

ATR "A" BATTERY ELIMINATOR

For Demonstrating and Testing Auto Radios—TRANSISTOR or VIBRATOR OPERATED!
 Designed for testing D.C. Electrical Apparatus on Regular A.C. Lines—Equipped with Full-Wave Dry Disc-Type Rectifier, assuring noiseless, interference-free operation and extreme long life and reliability.

MAY ALSO BE USED AS A BATTERY CHARGER
 MODEL 610C-ELIF . . . 6 volts at 10 amps. or 12 volts at 6 amps. Shipping weight 22 lbs. DEALER NET PRICE \$49.95
 MODEL 620C-ELIT . . . 6 volts at 20 amps. or 12 volts at 10 amps. Shipping weight 33 lbs. DEALER NET PRICE \$66.95

AUTO-RADIO VIBRATORS



By every test ATR Auto-Radio Vibrators are best! . . . and feature Ceramic Stack Spacers, Instant Starting, Large Oversized Tungsten Contacts, Perforated Reed, plus Highest Precision Construction and Workmanship and Quiet Operation!
 There is an ATR VIBRATOR for every make of car!

Ask your distributor for ATR's Low Priced type 1400, 6 volt 4-prong Vibrator; and 1843, 12 volt 3-prong; or 1840, 12 volt 4-prong Vibrator. THE WORLD'S FINEST!

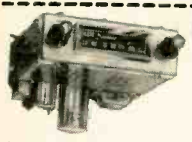

ATR UNIVERSAL KARADIO MODEL 600 SERIES

Easily installed in-dash or under-dash. Amplifier power-supply chassis may be separated from tuner chassis for installation flexibility and easy servicing. Utilizes 6-tube super heterodyne circuit (2 dual-purpose tubes) with 8-tube performance . . . pulls in those distant stations with good tone and volume. Supplied with separate 5" x 7" speaker which is installed in original automobile speaker compartment for high fidelity performance. Neutral gray-tan baked enamel finish. Overall size 4" deep x 6 1/2" wide x 2" high. Tuner Chassis; with Amplifier Chassis, 2 3/4" deep x 6 1/2" wide x 3 3/8" high. Shipping weight 7 lbs. WILL OUTPERFORM MOST SETS!

Model 612—12 volt Dealer Net Price \$31.96
 Model 606—6 volt Dealer Net Price \$31.96



ATR TRUCK KARADIO



Excellent Tone, Volume, and Sensitivity!
 Compact, yet powerful. Fits all trucks, station wagons, most cars and boats. Just drill a 3/8 inch hole in roof and suspend the one-piece unit (aerial, chassis and speaker) in minutes. Watertight mounting assembly holds antenna upright. Yoke-type bracket lets you tilt radio to any angle.
 Extra-sensitive radio has 6 tubes (2 double-purpose), over-size Alnico 5 PM speaker for full, rich tone. Big, easy-to-read illuminated dial. Fingertip tuning control. Volume and tone controls, 33-in. stainless steel antenna. Neutral gray-tan enameled metal cabinet, 7 x 6 1/2 x 4 in. high over-all. Shipping weight 10 1/2 lbs.
 Model TR-1279—12 A for 12V Dealer Net Price \$41.96
 Model TR-1279—6A for 6V Dealer Net Price \$41.96

SEE YOUR ELECTRONIC PARTS DISTRIBUTOR WRITE FACTORY FOR FREE LITERATURE . . .
ATR ELECTRONICS, INC.
 Formerly: American Television & Radio Co.
 Quality Products Since 1931
 ST. PAUL 1, MINNESOTA—U.S.A.



Simulated use of the new Command Pack during field testing. How the new pack looks.

The transceivers consist of a uhf unit with two channels between 250 and 350 mc, intended chiefly for ground-to-air communication; a 110-140-mc unit; one with a range from 38 to 50 mc, and a 4- to 20-mc transceiver. This lowest-frequency unit uses an external antenna, and can communicate up to 300 miles (500 miles under favorable conditions). The others are comparatively short range, and have their own whip antennas carried in an accessory case, which forms the top section of the command pack.

The equipment is designed for commando use, and enables a parachutist to operate a forward control command post, controlling both aircraft and ground troops and coordinating with more distant base stations.

FCC Takes \$ Action

FCC's Safety & Special Radio Services Bureau has imposed \$300 in forfeitures against Vincent R. Bannville, Sr., Fort Lauderdale, Fla., Citizens-radio licensee, for unauthorized communications, improper identification and false call signal.

This is the first monetary forfeiture action taken by the FCC under Section 510 of the Communications Act of 1934, as amended, and section 1.80 of the rules.

Teenagers

Born 15 years ago this month were the transistor, June 30, and the long-playing record, June 21.

Foreign Countries Pass US in TV Ownership

More TV sets are now in use abroad than in the US, reports *Television Factbook*. At the end of 1961, there were 54 million sets in foreign countries. By October, 1962, the total was 65 million, as against 60 million in the US.

Seventy-five foreign countries have 2,563 TV stations, while the US has 619, but the American total excludes low-powered translators and repeaters, though their equivalents are counted in the foreign total. Also, the US runs 35 stations for servicemen in US and overseas locations where English-language shows would not reach them.

The new nations of Africa play a large part in foreign TV growth, with the emphasis on commercial TV—even in countries where TV is run by government bodies.

Leading set-owning countries are: United Kingdom, Japan, West Germany, USSR, Canada, Italy, France.

Electronic Music

Electronic music has gained so much importance, says Dr. Albert Seay, Colorado College music professor, that courses in electronics are now a part of most young composers' training. Machines can determine the order and arrangement of sounds, reproduce them or simultaneously arrange and produce the sounds. Dr. Seay doubts, however, that electronic music will ever replace the traditional variety. END

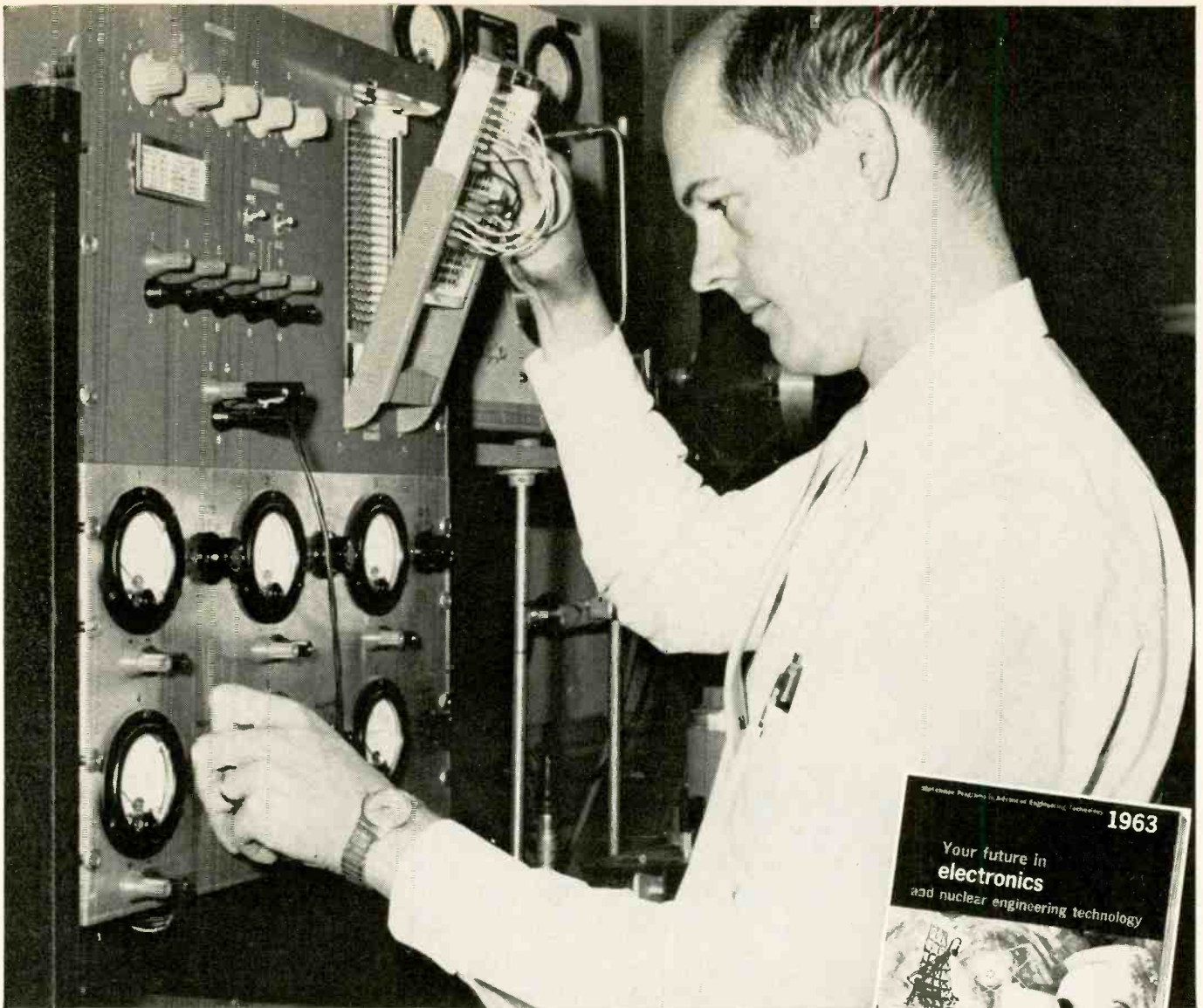

CREI GRAD ROY A. REICHERT makes an adjustment on the prototype of a programmable power supply which he designed and built in his capacity as Senior Technical Aide, Bell Telephone Labs, Murray Hill, N. J.

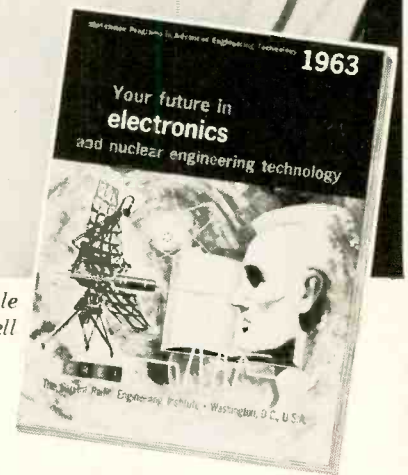

If you are employed in electronics

WE WANT TO SEND YOU THE FREE BOOK that started this man on the way to a rewarding career

Today Roy A. Reichert has a well-paying, exciting position in space age electronics. But he held a routine job when he sent for our free book, "Your Career in Electronics and Nuclear Engineering Technology".

From this 58-page book, he discovered the real reason why some men move ahead in electronics while others stand still. He learned the vital importance of advanced knowledge of electronics to a man who cannot be satisfied with an uninteresting, low-paying job. He found out why CREI Home Study Programs are recognized by leading organizations as particularly effective preparation for a career in advanced electronics. Mr. Reichert is just one of thousands of men in every phase of electronics who profited from reading this book. Send for free copy. Use coupon or write: The Capitol Radio Engineering Institute, Dept. 1406A, 3224 16th St., N.W., Washington 10, D. C.

	Founded 1927 Accredited Member of the National Home Study Council
	The Capitol Radio Engineering Institute Dept. 1406A, 3224 16th St., N.W., Washington 10, D. C.
Please send me FREE book describing career opportunities and CREI Programs in advanced electronics. I am employed in electronics and have a high school education.	
Name.....	Age.....
Address.....	
City.....	Zone..... State.....
Employed by.....	
Type of Present Work.....	
Check: <input type="checkbox"/> Home Study <input type="checkbox"/> Residence School <input type="checkbox"/> G. I. Bill	
50	



SNAP...

**in seconds...
all the power to bring
in weak channels**

**(without overloading)
on strong channels)**

NEW BLONDER-TONGUE ABLE-2

The new two transistor ABLE-2 is no ordinary booster—it performs better, longer than other home boosters available today. It's well worth the slightly higher price. The toughest weak signal problems are no match for the ABLE-2. List \$44.95

2 TRANSISTORS for more power on weak channels—handles up to 30X more signal voltage than one-transistor models without overloading
3-SET SPLITTER delivers sharp, clear pictures up to 3 sets with power to spare (TV, FM, COLOR)
'MIRACLE MOUNT' means fastest, easiest installation of any mast mounted booster
REMOTE AC POWER SUPPLY, stripless 300 ohm terminals and other features

Also available—New ABLE-1—Top Quality mast mounted 3-set TV/FM booster similar to ABLE-2, but with only one transistor. Recommended for weak signal areas only. List \$39.95

engineered and manufactured by
BLONDER-TONGUE

9 Alling St., Newark, 2 N. J.

Canadian Div: Benco Television Assoc., Ltd., Tor., Ont.

home TV accessories • closed circuit TV systems • UHF converters • master TV systems

Correspondence



Orchids from England

Dear Editor:

May I compliment you on the continued excellence of your magazine, which I have been taking without one missing number for 12 years. It has greatly assisted me in my post as radio and television service engineer, by its practical approach to all types of service. I have built test instruments from many of your articles, and the gear's in constant use on our service bench.

Your magazine is very highly respected by all the service engineers of my acquaintance, and by the Lecturers of our technical college.

Do you have anything on ham TV transmission using a flying-spot technique for transmitting film or slides? There seems to be a dearth of ham-TV information on this side of the Atlantic.

J. A. WALTON, A.M.I.S.M.

*Ribbleton, Preston, Lancs,
England*

[Thank you! On page 48 of our May 1962 issue, you'll find a TV camera you can build—though not a flying-spot type. Page 26 of *CQ* magazine for March 1963 offers "A Flying Spot Scanner," using mainly parts from two junked 630-type TV receivers.—*Editor*]

Lack of Good Technicians

Dear Editor:

Regarding the doubt of technician shortage, expressed in the letters in the April 1963 issue—I'm getting weary of hearing the same sob story: "Completed courses in electronics, but cannot find job, don't want job for less than \$100 a week, can't go where the openings are."

Yes, there *is* a shortage of technicians—*good* technicians. To qualify as a good technician, a man should have completed a good basic course and have had at least 2 years of experience. But to get that experience, he must be willing to work long hours for low pay, and to go where the work is.

Sitting home drinking beer and moaning the lack of \$100-a-week jobs under one's nose is not the way.

I got my start by completing a course and working as a radio shop flunky. Then I went on to be a TV field service man, TV benchman, shift TV transmitter man, maintenance man, maintenance supervisor, and finally my present posi-

NEW

PHOTOFACT® SERIES FOR SPECIALIZED SERVICING!

Here's timely service data coverage on specialized equipment—complete, uniform, authoritative PHOTOFACT service data now available only in handy bound-volume form. Take advantage of our money-saving Standing Order Subscription offer for any of the Specialized PHOTOFACT Series described below.



New Auto Radio Series

Six to eight of these bound volumes issued each year, to bring you complete PHOTOFACT service data coverage of Auto Radios. Each volume covers 40-50 popular late models. Regular price per volume, \$2.95—only \$2.65 when purchased on a Standing Order Subscription—you save 30¢ per volume!



New Transistor Radio Series

Twelve to fifteen of these volumes issued each year—complete PHOTOFACT coverage of Transistor Radios. Each volume covers 40-50 popular late models. Regular price per volume, \$2.95—only \$2.65 when purchased on a Standing Order Subscription—you save 30¢ per volume!



New Tape Recorder Series

Two volumes issued yearly, to bring you complete PHOTOFACT coverage of all important, late model Tape Recorders. Regular price per volume, \$4.95—only \$4.65 when purchased on a Standing Order Subscription—you save 30¢ per volume!



New CB Radio Series

Two to three volumes issued yearly—complete PHOTOFACT coverage of all popular CB Radio models. Regular price per volume, \$2.95—only \$2.65 when purchased on a Standing Order Subscription—you save 30¢ per volume!

**SAVE 30¢
PER VOLUME**

**SIGN UP TODAY FOR A STANDING ORDER
SUBSCRIPTION TO THE PHOTOFACT
SPECIALIZED SERIES**

With a Standing Order Subscription to receive the new PHOTOFACT Specialized Series of your choice as issued, you pay only \$2.65 for the Auto Radio, Transistor Radio and CB Radio Series, instead of the regular \$2.95 price; only \$4.65 for the Tape Recorder Series, instead of the regular \$4.95 price! Get the world's finest specialized servicing data and enjoy extra savings with a Standing Order Subscription. Sign up with your Sams Distributor, or send coupon now.

SAVE WITH A STANDING ORDER SUBSCRIPTION!

**SEND
COUPON**

HOWARD W. SAMS & CO., INC.

Howard W. Sams & Co., Inc., Dept. 6-F3
4300 W. 62nd St., Indianapolis 6, Indiana

Enter my Standing Order Subscription for the following:

Auto Radio Series CB Radio Series
 Transistor Radio Series Tape Recorder Series

My Distributor is: _____

Shop Name _____

Attn. _____

Address _____

City _____ Zone _____ State _____

the most noise-free recordings you have ever heard

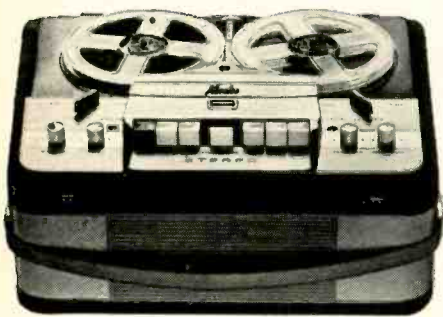

will be made on the new all-transistorized Norelco Continental '401' Stereo Tape Recorder, the only recorder using the newly developed AC107 transistors in its two preamplifiers. The AC107 is the only transistor specifically designed for magnetic tape head preamplifiers utilizing specially purified germanium to achieve the extraordinary low noise figure of 3 db, measured over the entire audio band (rather than the usual single frequency). This noise figure remains stable over large collector-emitter voltage swings and despite large variations in source resistance.

Hear the new transistorized Norelco Continental '401' • 4-track stereo/mono record and playback • 4 speeds: 7½, 3¾, 1½ and the new 4th speed of ¾ ips which provides 32 hours of recording on a single 7" reel • fully self-contained with dynamic stereo microphone, two speakers (one in the removable cover for stereo separation), dual preamps and dual recording and playback amplifiers • self-contained PA system • mixing facilities • can also play through external hi-fi system • multiplay facilities.

Specifications: Frequency response: 60-16,000 cps at 7½ ips. Head gap: 0.00012". Signal-to-noise ratio: better than -48 db. Wow and flutter: less than 0.14% at 7½ ips. Recording level indicator: one-meter type. Program indicator: built-in, 4-digit adjustable. Inputs: for stereo microphone (1 two-channel); for phono, radio or tuner (2). Foot pedal facilities (1). Outputs: for external speakers (2), for external amplifiers (1 two-channel); headphone (1). Recording standby. Transistor complement: AC 107 (4), OC75 (6), OC74 (2), OC44 (2), 2N1314 (2), OC79 (1). Line voltage: 117 volts AC at 60 cycles. Power consumption: 65 watts. Dimensions: 18½" x 15" x 10". Weight: 38 lbs. Accessories: Monitoring headset and dual microphone adapter.

For a pleasant demonstration, visit your favorite hi-fi dealer or camera shop. Write for Brochure F-6, North American Philips Company, Inc., High Fidelity Products Division, 230 Duffy Avenue, Hicksville, Long Island, New York.

Norelco®

In Canada and throughout the free world, Norelco is known as 'the Philips.'

tion. It took me 10 years. I am now 27.

From my job here, I can see that good technicians are hard to find. We find it difficult to fill openings with qualified personnel.

R. L. PEARSON
Chief Engineer, KHPL-TV
Hayes Center, Neb.

Too Complicated

Dear Editor:

This refers to the article in your February issue (page 40) entitled "Contact Load Multipliers".

I fail to see what Mr. Ives hopes to accomplish with his over-complex and costly circuit.

There is a much simpler approach than the one described in his article. Almost every relay manufacturer today makes a sensitive relay that operates at less current than the author's device.

Where Mr. Ives' circuit requires 96 mw, a sensitive relay by Kurman (310 DC 44) requires only 1.82 mw, (7.3V at .25 ma). This relay is suitable for rapid keying. It can be operated very easily with a photoconductive device, such as a Clairex CL-3. Contact current is 1 amp. This is more than necessary to key a power relay handling 20 to 30 amps.

The user of this particular relay need not construct a dc power supply. A 7.5-volt battery would last its shelf life. When the relay was energized, the current demand would only be ¼ ma.

The sensitive relay seems to me to be a more direct approach to the demands outlined by the author.

ARTHUR BONE

Durham, N. C.

Ives: Not Really

Dear Editor:

Mr. Arthur Bone points out, most correctly, that contact load multiplication can be done effectively by a cascade of relays, the first highly sensitive, the second designed for power handling. This is the classical method of handling a heavy load with delicate contacts. For many electrical control tasks, it is ideal, just as the wheelbarrow (invented by Leonardo da Vinci?) is the most economical earth-moving implement for many small construction jobs.

Mr. Bone's comments on the economy of using batteries in place of a power supply are likewise excellent, provided batteries can be obtained promptly and in new condition. At most isolated military installations, batteries are obtained from the Quartermaster warehouse, where they have spent most of their rated shelf life. Many "issue" batteries act like surplus from the Second Punic War!

Relay cascades become troublesome at high frequencies of operation. Relay response lags are additive. Where "kick" absorption is necessary, as in the vicinity of radio receiving equipment,

these lags are usually increased, and resonances are likely to occur at one or more operating speeds. Relays, particularly sensitive relays, are highly sensitive to vibration, and must be protected against chemical fumes (including "smog"), dust, insects, etc. Relays also require either periodic contact maintenance, or periodic replacement.

So, sensitive relays in much "must not fail" equipment are being replaced either by vacuum tubes or, more recently, by transistors. Wherever possible, transistors are being used, as they require no filament current, and many of them seem to be nearly immortal. By use of Darlington, and similar, amplifiers, contacts carrying only a few microamperes can control power relays which in turn can control many kilowatts. First cost of transistors, in many instances, is actually less than the first cost of a sensitive relay performing the same function. Sustaining cost of a properly designed and used transistor amplifier—the cost of maintenance and repairs from the time that the device is put into use until it is thrown away—is very low and often zero.

Whether to use a sensitive relay, a vacuum tube or a transistor, in a given circuit, can be decided only by a study of the exact operating conditions. In a surprising number of instances, at least two of the alternatives will do the job equally well. Then, "you pays your money, and you takes your choice."

RONALD L. IVES

Palo Alto, Calif.

Admires Tesla

Dear Editor:

You could not possibly have selected for your "Inventors of Radio" a more distinguished, prolific and worthy inventor than Nikola Tesla, who for so many years was misunderstood, even ridiculed, by so many professional engineers and scientists, over whom he towered by his advanced thinking. Only since his death have his great contributions to science and technology been properly appreciated.

I prize highly an autographed, 36-page paper of his, published in *The Century Magazine*, June 1900: "*The Problem of Increasing Human Energy*, with special reference to the Harnessing of the Sun's Energy." This should be added to Mr. Bartlett's references.

My correspondence with Tesla was given many years ago to Kenneth M. Swezey, 163 Milton St., Brooklyn, N. Y., who is probably the best living authority on Tesla, and who has collected much information about him.

BENJAMIN F. MIESSNER

Miami Shores, Fla.

[The correspondence with Mr. Tesla has since been given by Mr. Swezey to the Manuscript Division, New York Public Library.—Editor]

END

The Star-Spangled Banner

Francis Scott Key

John Stafford Smith

With spirit
O say! can you see, by the dawn's ear-ly

Piano

light, What so proud-ly we haild at the twi-ght's last

gleam-ing? Whose broad stripes and bright stars, thro' the per-ilous



Two things you're sure to hear at a public event

Wherever people gather, wherever words and music must be heard with perfect fidelity, you're sure to hear University...largest selling P.A. loudspeakers in the world.

University is Public Address. The reasons can be summed up in two words, **high audibility**—"High A", that special engineering factor built into University P.A. speakers to give them an extra degree of intelligibility, a clean, crisp, sound no other P.A. speakers can match. You hear the proof at political rallies and conventions, in the great

churches, stadiums and arenas, in hospitals, factories, missile bases—everywhere from Presidential inaugurations to Little League play-offs.

You can't lose a P.A. customer when you have the superiority of over 62 different University speaker products in every price range behind you. Write Desk J-6 for our latest P.A. catalog:

UNIVERSITY LOUDSPEAKERS
OKLAHOMA CITY, OKLA.
A Division of Ling-Temco-Vought, Inc.

Send all equipment for service to our newly located Service Dept., 9500 W. Reno, Oklahoma City, Okla.

Can you find
another kit that
offers so much
for \$99⁹⁵?



EICO ST70, 70-WATT STEREO AMPLIFIER

Beyond the performance level of these two units, possible improvement is merely marginal and very expensive. That's why with EICO's ST97 and ST70 you strike the optimum balance of cost and performance—each costs less than \$100 as a kit. You can also get the ST70 and ST97 factory-wired for \$149.95 each—and you couldn't find comparable wired units at the price.

If high power isn't your primary need, you can get superb sound for even less with EICO's ST40, the 40-watt counterpart of EICO's outstanding ST70. The ST40, essentially equal to the ST70 in all but power, costs \$79.95 as a kit, \$129.95 factory-wired.

ST70 DATA: As the center of your stereo system, the ST70 accommodates all program sources. It even has separate inputs for both turntable and record changer, preamplified tape signals and tape head with correct equalization for both fast and slow tape speeds. A center channel output feeds directly on a center channel speaker or, where desired, extension speakers throughout your house without any additional amplifier. Critical parts—filter capacitors, rectifiers, output tubes—all operate well below their ratings to assure long, trouble-free life. Oversize output transformers deliver full rated power all the way down to 30 cps. . . . And as a kit builder, you'll like the spacious layout. We got rid of all those tight places. Kit \$99.95. Wired \$149.95 (includes metal cover).

SPECIFICATIONS ST70 Output Power: 70 watts (continuous sine wave 35-watts per channel) *IM Distortion:* 1% at 70 watts. *Harmonic Distortion:* less than 1%. *Frequency Response:* $\pm 1/2$ db 10-50,000 cps. *Inverse Feedback:* 17 db. *Stability Margin:* 10 db. *Hum and Noise Level:* * mag. phono —63 db; tape head —54 db; tuners, auxiliaries —78 db. (all measurements according to IHFM standards.)

Can you find
another kit that
offers so much
for \$99⁹⁵?

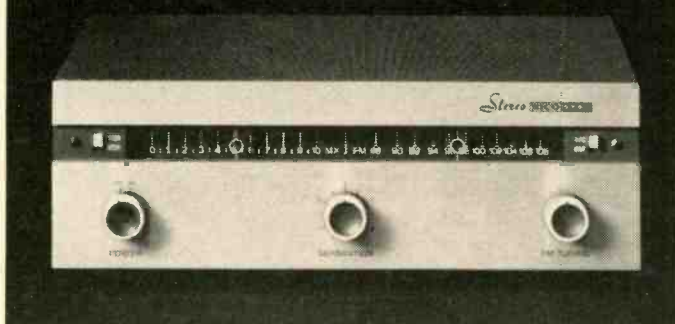

EICO ST97 FM STEREO TUNER

ST97 DATA: Building the ST97 FM stereo tuner requires no instruments, no critical adjustments. The front end and IF stages are fully pre-wired and pre-aligned. The tunable coils of the stereo demodulator are factory-adjusted. With four IF stages plus a stable, sensitive front end, the ST97 pulls in clear stereo even under fringe conditions, and EICO's filterless zero-phase shift stereo detector (patents pending) maintains reliable channel separation. EICO's unique traveling tuning eye makes tuning simple and precise. Stereo stations are automatically identified by a pilot light. Semi-kit \$99.95, Wired \$149.95. (Includes metal cover and FET.)

SPECIFICATIONS ST97. Sensitivity: $3\mu\text{v}$ (30 db quieting), Sensitivity for phase-locking (synchronization) in stereo: $2.5\mu\text{v}$. Full limiting sensitivity: $10\mu\text{v}$. *Detector Bandwidth:* 1 megacycle. *Signal-to-Noise Ratio:* -55 db. *Harmonic Distortion:* 0.6%. *Stereo Harmonic Distortion:* less than 1.5%. *IM Distortion:* 0.1%. *Frequency Response:* ± 1 db 20 cps-15 kc. *Capture Ratio:* 3 db. *Channel Separation:* 30 db. *Controls:* Power, Separation, FM Tuning, Stereo-Mono, AFC-Defeat (all measurements to IHFM standards).

*Actual distortion meter reading of derived left or right channel output with a stereo FM signal fed to the antenna input terminals.

See these superb components at high fidelity dealers everywhere. For FREE 32-page catalog, 36-page Stereo Hi-Fi Guide (enclose 25c for handling) and dealers name, write: EICO ELECTRONIC INSTRUMENT CO. INC., 3300 Northern Boulevard, Long Island City, New York.

Dept. C-6



Add 5% in West.



RP 100 STEREO TAPE DECK
semi-kit \$299.95 wired \$399.95



NFS-6 3-WATT
3-SPEAKER SYSTEM
kit \$52.50 wired \$62.50

AFTER THE COMPUTER, WHAT?

... *The Intellectron May Replace Most Computers* ...

A COMPUTER, according to the dictionary, is a machine which reckons and calculates. Modern electronic computers do just that. They also must be instructed by man *exactly* what to do, i.e., they must be *programmed* first. They cannot operate by themselves, and, most important, they cannot think. They are at best excellent ultra-rapid calculators.

Says Dr. Philip M. Morse, Professor of Physics and director of the Computation Center of the Massachusetts Institute of Technology: "The present state of computer design compares to automobile design of 1913."

In the 1962 meeting of the Conference on Self-Organizing Systems in Chicago and New York, sponsored by the Office of Naval Research and the Armour Research Foundation, the talks centered on machines, devices and systems that could "learn" from experience and conduct themselves accordingly. The main obstacle, the speakers confessed, was lack of information on how the human nervous system operates during thinking processes. This, in their opinion, points to the long paths that lie ahead of true "thinking machines."

Animal experiments have revealed that single "bits" of information are stored at various points in the brain. All or most are scanned when one tries to recall certain pertinent information. Some speakers pointed out that the human brain contains more than 10 billion memory units, which makes it almost hopeless to construct a like electronic "brain" without some units failing.

What, then, can we reasonably expect in the foreseeable and the more distant future? Most scientists today are not too hopeful that present types of computers can be made to "think" or reason by themselves.

Says Dr. Marshall C. Yovits of the Office of Naval Research: "Some of the much-publicized systems, allegedly capable of learning or recognizing, must be taken with a grain of salt!"

Let us therefore—with our present limited knowledge—first explore the only successful thinking machine in existence: the human brain. We had best start with an infant and review some of the processes by which he learns to think. An infant, isolated in darkness in a totally silent room, fed mechanically for some years, will never learn how to think properly. It will grow up an idiot or be feeble-minded.

Compare this with a normally brought-up child. It gets its most important impressions via the eyes and ears. (We disregard for the moment the senses of taste, odor and touch.) We also believe today that all senses are neuro-electric. The brain, we know, stores all impressions from the outside world in the 10 billion odd memory cells as electric impressions. Sight impulses, we also know, are impressed on the brain cells by photoelectric means. Sound impulses are recorded via audio, much as sounds are recorded on phonograph records, but instead of on a spiral groove, the recording is registered on millions of fixed memory cells.

Mark well that what we said above is only the merest approximation to the subject. More important is the subject of *learning* and understanding. Thus, comparatively little of what the infant learns the first year stays with him into manhood. It is the constant repetition that probably counts. It would seem that the very young child learns only slowly—a long and tedious process. Possibly his memory cells are not

ready for permanent recording in depth. They probably must first grow and become sensitive enough for the various multiplex impressions. Then we must never forget that we have to do with a continuously *living* organism that also has inherited genes which will affect his thinking processes. There also is the important factor, only vaguely understood as our *intellect*, the ability to reason, perceive or understand; the ability to perceive relations, differences, etc., distinguished from *will* and *feeling*. There is much more than this, but we cannot here cite all textbook facts on this vast subject.

The present discussion was started only to try to compare a living brain with the requirements of a future mechanism that can duplicate the vast functions of a living organism.

This is a formidable undertaking that will take not only great ingenuity but many years. Also, it requires a number of breakthroughs in some areas which are not even dreamed of today.

But we should not despair, because certain advantages of an "electronic brain" are lacking in a biological one. Thus we have distinct advantages in electronic speeds, compared with biologic nerve impulses which are excessively sluggish—millions of times slower.

Nor do we have to wait 18 to 20 years for our electronic brain to "grow up" and mature. The human learns practically nothing while it sleeps for one-third of its life, while its electronic counterpart can work at much higher speeds for a 24-hour day.

Still, it too takes a considerable time to digest, file and cross-file facts in its billions of memory cells, once these have been perfected even in a rudimentary fashion.

We cannot hope to create a thinking machine with present-day magnetic memories *alone*. The future memories must record *in addition* with photoelectric means as well as with audio waves. *In other words, the future electronic brain must see as well as hear.* The other three senses may be added later when required.

It is easy to understand that the true *thinking* electronic brain is light-years away from the present-day computer. As a matter of fact, we had better disregard computers that must be constantly programmed. We urgently need a new term to describe the future thinking machine. Even the electronic brain falls far short of what is needed.

For want of a better term, we suggest the name *intellectron*. We believe it means what it says.

Let us caution that even when all breakthroughs and numerous obstacles have been conquered, the future intellectron must still learn millions upon millions of facts, like any bright youth. *This takes time.* It cannot be done instantly. Brahms symphony cannot be *recorded* in seconds. Nor can the history of the United States be *recorded* in seconds, if the thinking machine is to digest, *understand* and evaluate properly all material that it is constantly fed. Personally, we would be surprised if a fully completed intellectron could be turned out in a year, because of the long recording time.

Mass-produced, such machines could all be turned out by the thousands to lower their cost. Mass production would require *mass instruction*, too, at the same time, but it would

(Continued on page 46)

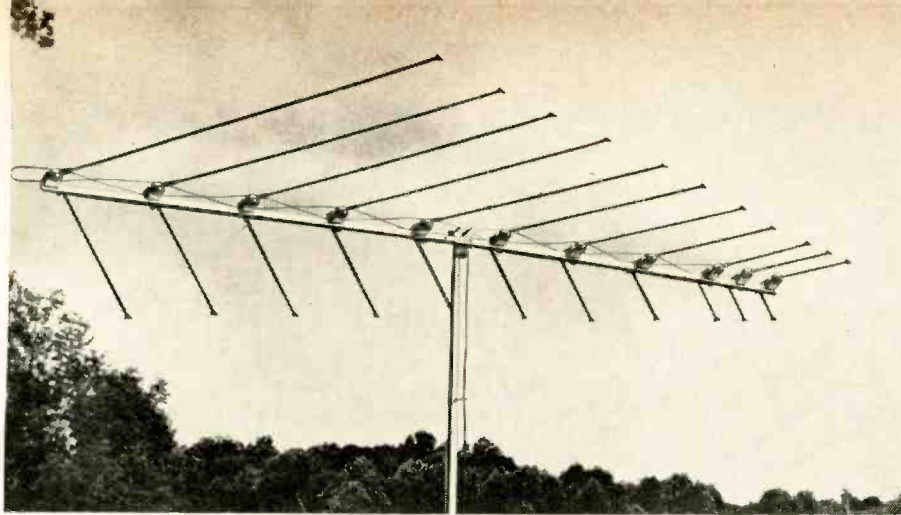

LOG PERIODIC V

Complete information on the new high-gain all-channel TV antenna concept

CERTAIN LIMITATIONS HAVE BEEN INHERENT in TV antenna design for so long that they have been accepted as axiomatic. No commercial antenna has had uniform high gain over the complete vhf TV band. It has been assumed that an all-channel antenna is not possible except by a compromise design that gives up a little bandwidth to get a little gain, or vice versa. The gain curves of modern TV receiving antennas are studied with peaks and valleys that show, only too well, how they depend on frequency.

Most antennas for fringe-area reception are based on the Yagi design.

* Executive vice president, sales and engineering, JFD Electronics Corp.

By EDWARD FINKEL*

The Yagi has high gain and high front-to-back ratio. But it is essentially a narrow-band antenna—it cannot cover the entire vhf TV band from 54 to 216 mc. A simple Yagi is most effective for a single channel, a spread of only 6 mc. Modified Yagis, with dipoles cut for the center of the low and high bands and an array of various-size parasitic elements for broadening bandwidth, generally have good gain at the high end of each band and degenerate at the low end. This is the fate of *any* antenna burdened with a large number of parasitic elements. These lower the charac-

teristic impedance at the low end of each band, and make for signal-sapping standing waves and impedance mismatches between the antenna and the transmission line.

For more than 8 years, a group of antenna scientists at the Antenna Research Laboratory of the University of Illinois has been experimenting with vhf and uhf antennas that have no theoretical limitations on bandwidth—are frequency-independent. Various experiments led Profs. V. H. Rumsey and J. D. Dyson to the log spiral antennas. Out of this research came the sharply directional, yet broad-band, conical spiral antenna now being used for satellite tracking.

Prof. R. H. Du Hamel next tried and succeeded in developing a linearly polarized antenna based on the conical spiral, and Prof. Paul Mayes with R. C. Carrel and D. E. Isbell further developed this design to the point where it was basically suitable for television. JFD antenna engineers worked with the University of Illinois scientists to develop the final versions of the *log periodic V*, or LPV, antenna for television. The LPV promises to revolutionize the TV antenna field. Although it is now designed to cover uniformly both the low and high vhf TV bands and the FM band in between, a frequency spread of 4 to 1, this antenna type can easily be extended to include uhf. The unique thing about it is that within each TV band its impedance, gain, reception pattern and front-to-back ratio are virtually constant. The gain for each channel is as high as that furnished by a comparable sized, single-channel Yagi.

Log periodic concept

Essentially, the LPV antenna incorporates two separate design concepts: the log periodic factor, which deter-

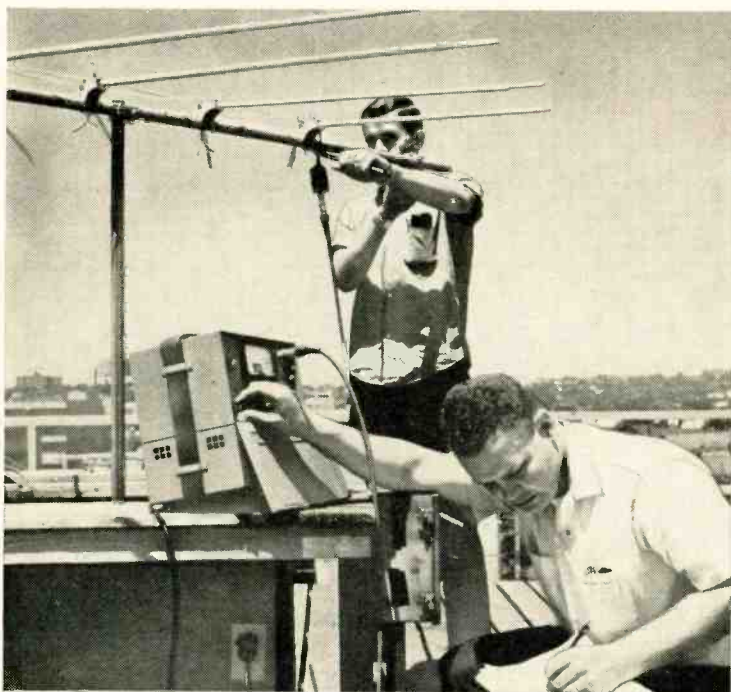

Technicians checking characteristics of a prototype LPV antenna at the JFD laboratory in Brooklyn.

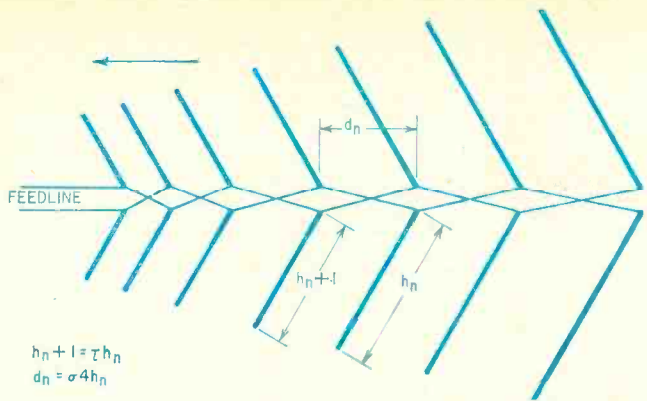

Fig. 1—Fundamental LPV. Bandwidth and directivity are controlled by length and spacing ratios of adjacent dipoles.

mines the size and spacing of the elements; the forward V shape of the elements, which permits multi-mode operation and determines its directionality. Let us first consider the periodic function.

The basic planar log periodic antenna is an array of dipoles in which the length of each element bears a fixed ratio to the length of the preceding element. This ratio is called the *scale factor* and is designated by the Greek symbol τ (tau). The spacing between adjacent dipoles may also be fixed by a ratio, σ (sigma). These relationships are shown in Fig. 1, where h denotes element half length and d represents the spacing between dipoles.

The actual values of tau and sigma were derived from many experimental models and tests and finally selected from tables which combine these test results. The directivity of the antenna increases with increasing tau, and sigma must be small to obtain higher mode (harmonic) operation, important for high-band reception. (The mode desired multiplied by sigma should equal 0.2 to 0.4.) Since, for TV, the third mode is desired (as will be explained later), a good value for sigma is .085.

Each of the dipoles in the antenna is equal to an adjusted half-wavelength at a different frequency, making the dipole resonant to that frequency. The scaling factors τ and σ are so chosen that the desired frequency range is covered with elements whose resonances overlap. Thus, as the frequency changes, resonance moves smoothly from one dipole to the next.

Typical values of tau and sigma are 0.9 and 0.085, respectively. These in fact are the actual values used in one of the many experimental models developed in the JFD laboratories. This is a seven-element antenna, 92 inches overall, with h_1 , the half length of the longest element, 56 inches, approximately one-quarter wavelength at channel 2. Lengths of all other elements are determined by the equation in Fig. 1. A diagram of this antenna is shown in Fig. 2.

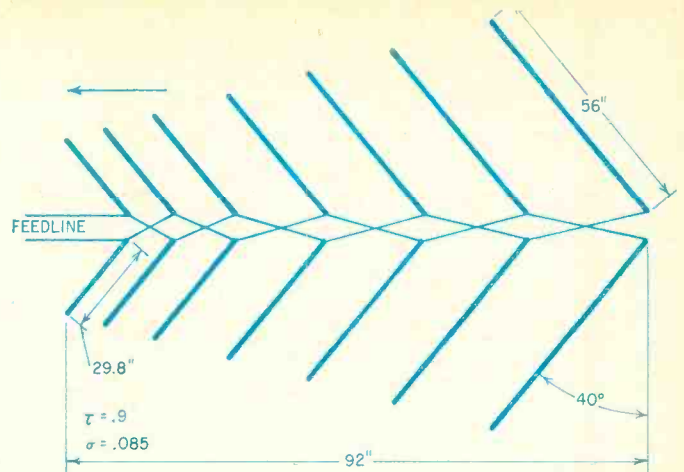

Fig. 2—An experimental LPV, showing relation of element length and spacing.

In designing the larger LPV models it was necessary to depart slightly from the log periodic formula, to make the antennas commercially and mechanically practicable.

Fundamental operation

Just as the largest dipole of the LPV antenna corresponds to a half-wavelength on channel 2 many of the other dipoles more or less correspond to the half-wavelengths of the other channels in the low TV band. Although one particular dipole—the one closest to the resonant length—absorbs the greatest amount of signal at any particular received frequency, the adjacent elements also absorb signal energy. How much is shown in Fig. 3, a curve representing the distribution of current at the terminals of each dipole of a nine-element LPV antenna on channel 5. Note that while maximum energy is absorbed by one dipole, No. 5, two other elements, Nos. 4 and 6, absorb 60% as much, and even elements 3 and 7 absorb substantial amounts of signal (30%).

The resonant or near-resonant dipole together with those adjacent elements that contribute substantial signal energy at the received frequency, plus the crossed phasing harness, constitute the "active cell" for that channel. As the frequency of reception increases, the active region moves toward the front of the antenna; for each channel a different active cell is formed.

The tau and sigma used in the design of an LPV are the key in providing a wide active reception region for every channel. When these two factors are selected properly, the dipoles of the active cell present a low impedance at their terminals, resulting in high energy absorption. This low impedance results from a combination of element length and the spacing determined by the log periodic equations, as well as the thickness of the elements.

High-band operation

For channels 7 through 13, the large elements at the rear of the antenna constitute 3/2-wavelength dipoles. Therefore, they resonate to the received frequency at the third harmonic mode. The large elements at the rear of the antenna are 3/2 wavelength at channel 7. As the frequency increases toward channel 13, the 3/2 wavelength elements, and therefore the active region, shifts toward the apex of the antenna. The actual gain realized by third-harmonic operation is shown in Fig. 4, the vhf gain curves for the JFD LPV-11, an 11-element antenna. From these curves it is apparent that there is an average increase of 3 1/2 db in gain on the high band vs the low band. This is in accordance with good TV antenna design, which requires greater gain on the high band because of the greater transmission signal losses at these frequencies.

Fig. 3—Distribution of channel 5 currents on individual elements of a nine-element LPV antenna.

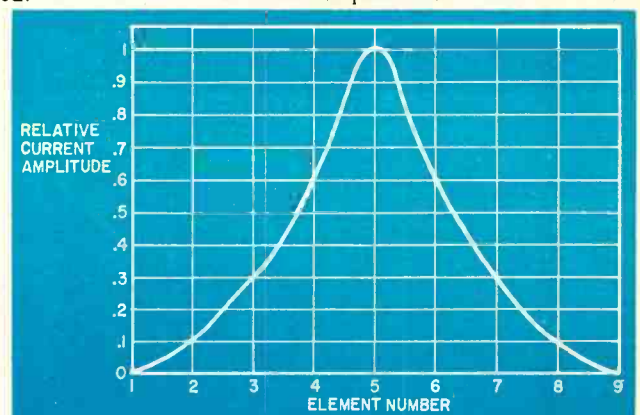

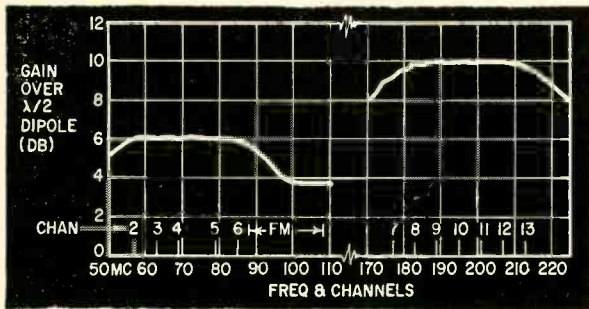
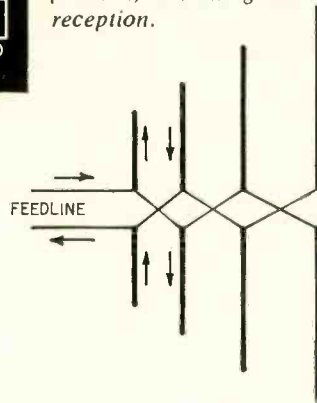

Fig. 4—Gain curves over TV and FM bands.

Fig. 5—Current on adjacent elements is in opposition, cancelling side reception.



of the elements and the phase-reversed feeder.

Consider Fig. 5, a simplified diagram of a four-cell LPV antenna, front-fed, using a twisted phasing harness. Note that because the elements of the adjacent dipoles are not fed in parallel, they are in phase opposition. This effectively cancels reception from the sides. Furthermore, the length of the harness plus the space between adjacent elements adds up to produce a 360° phase shift between the signals reaching the first and those being picked up by the second element (or between any two adjacent elements) in the forward direction (toward the feedline, at the small end of the antenna). This 360° phase shift actually puts both waves in phase for additive signal strength.

Toward the rear, on the other hand, there is only a single 180° phase shift, due to the crossed harness. This effectively cancels reception from adjacent elements towards the rear.

The signal finds itself in somewhat the position of a motorist going down an avenue that has phased traffic lights. Arriving at the front (small end) of the antenna, it finds each element in turn phased in its favor, and gives up a maximum of its energy to the antenna. If it arrives from the rear, it finds each alternate element phased against it, and is effectively cancelled out.

Directional sensitivity is increased and reception from the rear further reduced by V-ing the elements forward. A straight half-wave dipole receiving a signal three times its resonant frequency has a radiation pattern like that shown in Fig. 6-a. The signal sensitivity is dissipated in three forward lobes. If the elements of this same dipole are directed forward into a V, the pattern becomes Fig. 6-b. The two side lobes are brought together and merged with the center lobe as the elements are brought toward each

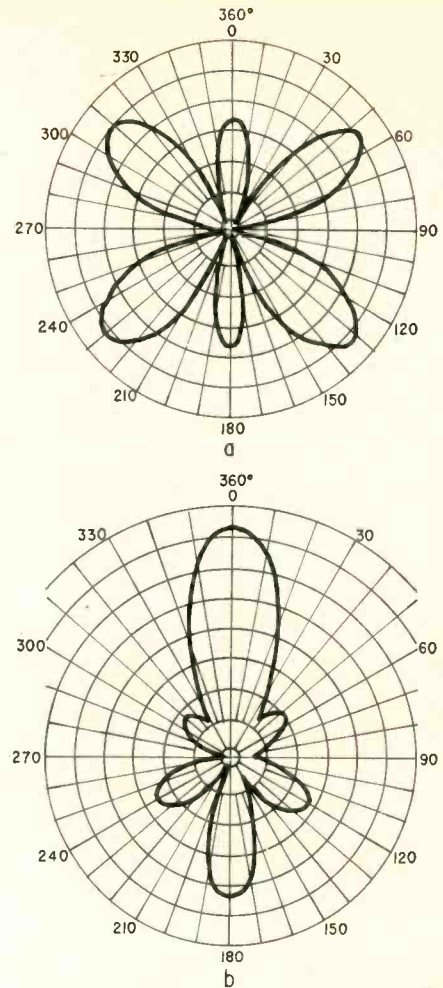

Fig. 6-a—Polar pattern of half-wave dipole at three times its fundamental. b—Pattern of same dipole with ends bent forward into a shallow V.

other. The rearward lobes are "phased out" in the feedline.

Reception patterns for the complete LPV TV antenna are shown in Fig. 7-a for the low band, sharpening up to 7-b on the high band. This type of pattern is maintained through the FM band too. In actual tests the LPV-11 with 9 active cells and 2 directors maintained a front-to-back ratio of 35 db, with a gain of 8 db across the low band and 11½ db across the highs. In comparison, a somewhat longer Yagi antenna, adjusted to a front-to-back ratio of 25 db at the middle of its band, fell to 15 db at the edges, and more important, had a bandwidth of only 7%, at a gain equal to that of the LPV.

Although reflector elements are unnecessary for the LPV, directors are desirable to "peak up" the high end of the upper vhf band, particularly for fringe-area reception. The director spacing is determined experimentally since it must not affect the input impedance of the antenna itself. Laboratory tests recommended a spacing of approximately half the distance between the two shortest active elements of the antenna. Director length is shorter than the

In all other respects, operation is the same as on the low band. Active cells embracing several elements for each channel and low impedance at the received frequency are basic to the antenna.

A close inspection of Fig. 4 shows that the gain of the LPV-11 is uniform across all channels for each band. This guarantees good color TV reception. For color fidelity, the gain on the brightness and color carriers within each channel must be nearly the same. Obviously this can only hold true if the antenna has a flat gain response curve for the entire channel.

If the input impedance of an antenna varies appreciably from that of the transmission line at any point in the bandwidth of the antenna, a mismatch will exist between the antenna and downlead. Such a mismatch decreases signal power to the TV set and introduces standing waves along the line. This leads to further signal reduction and ghosts.

The LPV is unique in that it maintains essentially constant impedance across the full bandwidth of the antenna. An important reason for this is that the input impedance of the LPV depends primarily upon the impedance of the feeder network, which can be easily controlled. In the JFD LPV series, the feeder consists of a crossed network of solid bars whose diameter, length and spacing are determined to give an exact match to 300-ohm transmission line. That this is the case is proved by measurements of the vswr which are consistently in the area of 1.2 to 1.

Directivity, front-to-back ratio

As important as high gain and constant impedance are in fringe-area reception, the antenna would be worthless without good directional sensitivity. Even in the heart of cities, directivity is needed to reject the ghost-causing interference signals that bounce from building to building. In fringe areas, interfering signals from adjacent channels picked up by the antenna from the rear and sides cause venetian-blind and herringbone effects, fading and other picture distortions.

Yagi antennas obtain good directional sensitivity and high front-to-back ratios with parasitic elements (directors and reflectors). The LPV obtains its sharp forward pattern from the V-ing

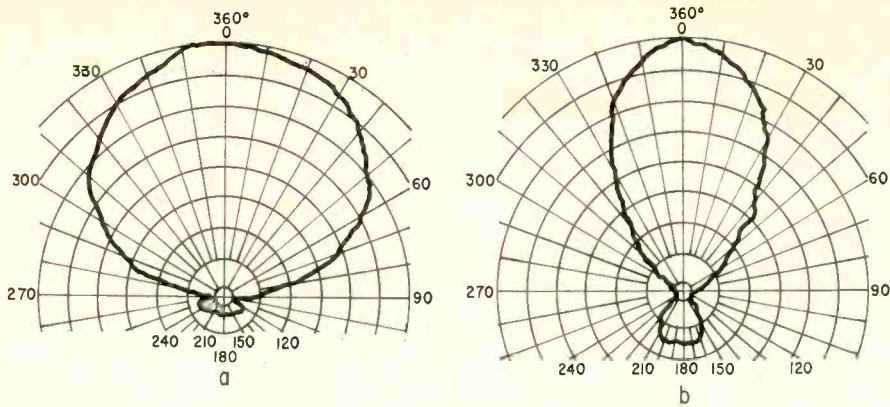

Fig. 7-a—Polar pattern of LPV on low TV band. b—Same antenna on high band.

shortest active elements—theoretically, it should be 0.46 multiplied by the half-wavelength of the frequency to be “peaked”.

City and far fringe

Since the frequency independence of the LPV depends on the scaling of the cells, any number of intermediate cells may be narrowed without affecting the essential characteristics of the antenna. To narrow an antenna, a smaller value of tau is chosen, so that the shortest element is approached faster, omitting some elements in between. Nar-

rowing the cells will reduce the gain but will not affect the front-to-back ratio, directivity and constant-impedance characteristics, which do not depend on the number of elements used, only on the adherence to the proper scaling factors and equations.

When a shortened LPV is used in a strong-signal area, the increased signal strength will compensate for the fewer total signal-absorbing elements. At the same time, it is no less important that suburban and city viewers use an antenna with high front-to-back ratio and low vswr to eliminate ghosts caused by

signal reflection from tall buildings.

There are presently six models in the LPV series made by JFD. The shortest, the LPV-4, contains 4 active cells and is recommended for use up to 50 miles from the TV transmitting antenna; in other words, in city and most suburban areas. The largest is the LPV-17 with 8 active cells and 10 passive elements. This one is designed for use up to 175 miles from the transmitter under virtually ideal conditions. Between these two are four other models for any reception area.

Since element spacing and V-ing are critical, special mechanical innovations were needed to assure antenna rigidity. The crossarm is made of extra-heavy-gage aluminum, 1 inch square. Every element has sleeve reinforcements to prevent bending. The phasing harness is made of 1/8-inch solid aluminum rod, cold-welded into position. Other mechanical features are “flip-quick” construction for ease in erection, gold alodizing and the inclusion of a double U-bolt assembly.

A fortunate dividend in the LPV design is its “compatibility” with uhf. When and if combination vhf-uhf antennas find an increasing market, it is almost certain that the LPV will be one of the leading all-band designs. END

blind learn electronics in special school

THE EDUCATION OF THE BLIND IS A SPECIALIZED process that calls for apparatus designed for tactual demonstrations, books printed in Braille and specially trained instructors. These photos were taken at the New York Institute for the Education of the Blind, 999 Pelham

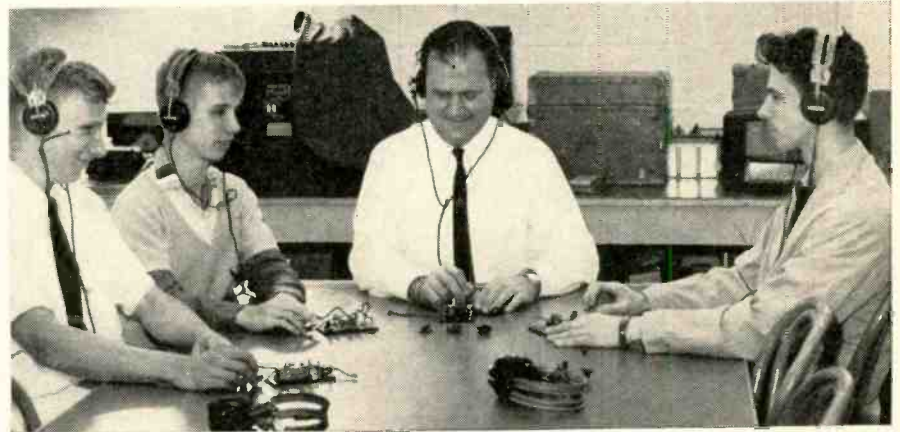

Parkway, New York 69, N. Y. The oldest school of its kind in the Western Hemisphere, it was founded in 1831. Instruction is shown under the guidance of Bob Gunderson, blind radio engineer, inventor, and editor of the Braille Technical Press. He developed specialized auditory test equipment for teaching electronics to the blind, making measurements in the laboratory, repairing electronic equipment and tuning a radio transmitter (RADIO-ELECTRONICS, March 1951, “Blind Improve Test Gear”).

Training at the institute consists of a graded academic program, manual training (machine shop and woodwork) and electronics, along with a physical education program including rowing, wrestling and track. END



get the **BEST** from those ceramic cartridges

They sound fine when used right — and they can lick hum problems, too

By **HERMAN BURSTEIN**

RECENT REVIEWS OF SOME CERAMIC cartridges have hailed them as equal to all but the finest magnetic pickups in frequency response, distortion, compliance, and stereo separation. Moreover, the ceramic cartridge has several distinct advantages over the magnetic: it has some 20-db higher output, making possible a higher signal-to-noise ratio. Usually it costs substantially less than a magnetic of comparable quality and, because of the higher output and the different equalization requirements, you can dispense with the preamplification required for a magnetic pickup. Thus the ceramic *can* be connected directly to the high level input of an amplifier (though this is not always the best way).

Not every so-called high-fidelity installation is a "dream" system. Many are of middle or even borderline grade. A high-quality ceramic pickup can be considered compatible with moderate systems, particularly if cost is important. In addition, many home installations that do not qualify as high fidelity are nevertheless capable of yielding pleasure

Plug-in adapters supplied by cartridge manufacturer are best and simplest way of converting ceramics to velocity devices. At right is the Sonotone 9TAF cartridge; below, a matched pair of adapters for it.

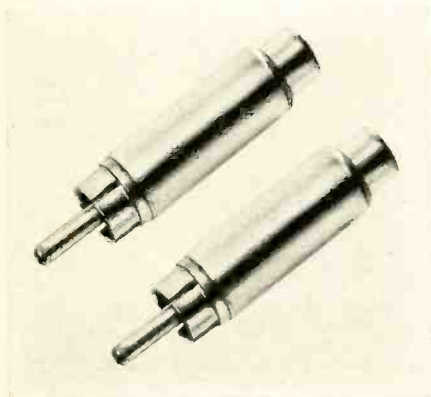

to their owners. Most of these systems can't use magnetic cartridges because they lack preamplification. Quality can be improved with a *good* ceramic.

Unfortunately, you can't simply connect a quality ceramic pickup to an amplifier and be certain that good results will automatically follow. An acquaintance recently purchased a highly rated ceramic pickup for his portable stereo phonograph. He complained that the new cartridge lacked bass. I suggested that he solder a .001- μ f capacitor in parallel with the cartridge leads for each channel. He reported next day that bass was fine.

In a while we'll find out why it was necessary to alter the load across the

cartridge by adding capacitance. Incorrect loading deprives a ceramic cartridge of the chance to show how well it can perform. Incorrect loading may reduce bass, it may permit excessive signal input, or may exaggerate treble response.

A ceramic cartridge can be used in two ways:

1. As an *amplitude device* (which it is by nature), producing a signal proportional to the *amplitude* of the record groove. In this case, the cartridge is connected to the *high-level* input jack of an amplifier.

2. As a *velocity device*, so that, like a magnetic pickup, it produces a signal proportional to the *speed* of the wiggles in the groove. This speed de-

Fig. 1—RIAA playback equalization curve for magnetic and ceramic cartridges.

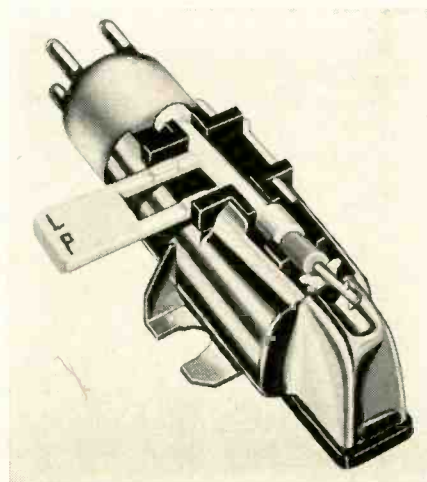
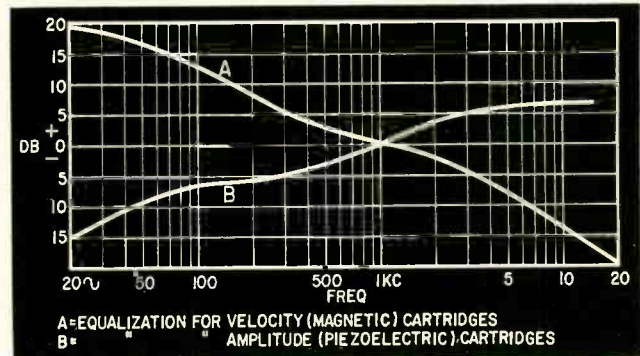

pends not only on the amplitude of the groove but also upon the recorded frequency. A suitable loading network converts the ceramic pickup into the equivalent of a true velocity device. The signal is then fed into an input jack intended for a *magnetic* cartridge.

We'll examine how loading problems can arise whichever way a ceramic cartridge is used.

Amplitude device

We usually look at RIAA playback equalization from the viewpoint of the magnetic cartridge, which requires a large amount of bass boost and treble cut, as shown by curve A in Fig. 1. But from the viewpoint of an amplitude-responsive cartridge, RIAA playback equalization calls for a large amount of bass *cut* and moderate treble *boost*, as shown by curve B in Fig. 1.

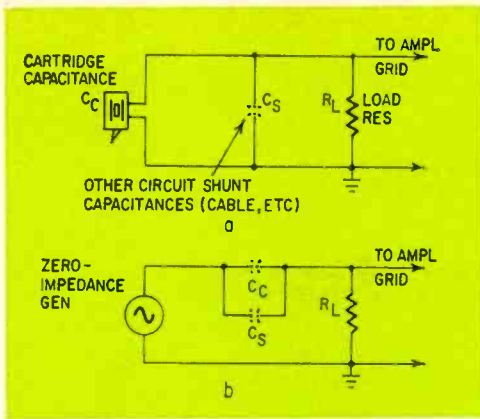

Fig. 2-a—Typical ceramic cartridge circuit; 2-b—equivalent circuit of (a). Cartridge can be considered ideal generator in series with cartridge and circuit capacitances.

When used as an amplitude device, the ceramic pickup is fed into the high-level input of an amplifier. But a high-level input provides *no* equalization, whereas Fig. 1 shows that equalization is necessary. The answer is that the ceramic cartridge is considered to be a self-equalizing device with respect to the RIAA curve. Let's see if this is so.

First, treble boost. Like other physical devices, the ceramic pickup has a resonant frequency, in this case near the high end of the audio spectrum. Through proper design, including damping, the resonance is controlled so that it approximates the required treble boost of curve B. Hence the cartridge is indeed self-equalizing for treble.

Now, bass cut. The ceramic cartridge is itself a capacitance, typically ranging from about 300 to 600 pf, although sometimes going a good deal higher. Together with the load resistance presented by the amplifier, the cartridge capacitance plus other circuit capacitances (that of the connecting cable and the input capacitance of the amplifier) form a simple bass attenuation circuit, as in Fig. 2-b. The ceramic cartridge is not completely self-equalizing in the bass region but is very much dependent on the load resistance. It is also moderately dependent on other circuit capacitances.

It works out that if the circuit capacitances in conjunction with the load resistance have a time constant of about 1,200 μ sec, response will generally approximate the RIAA bass cut. Assume that the cartridge capacitance is 450 pf, while other circuit capacitances amount to 150 pf—both fairly typical values. Total capacitance is therefore 600 pf. Dividing 1,200 μ sec by 600 pf yields a required load resistance of 2 megohms. Fig. 3 shows the approximation to RIAA bass cut when the circuit impedances have a time constant of 1,200 μ sec. (The "bulge" in response in the middle of the bass range can be reduced by using a more complex load

The Electro-Voice 27 (and 27D) is a ceramic cartridge with built-in velocity characteristics.

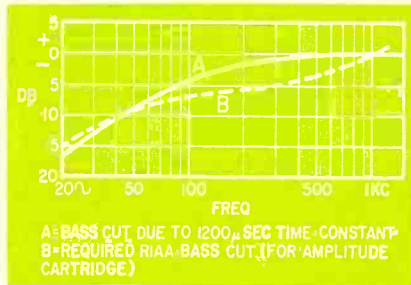
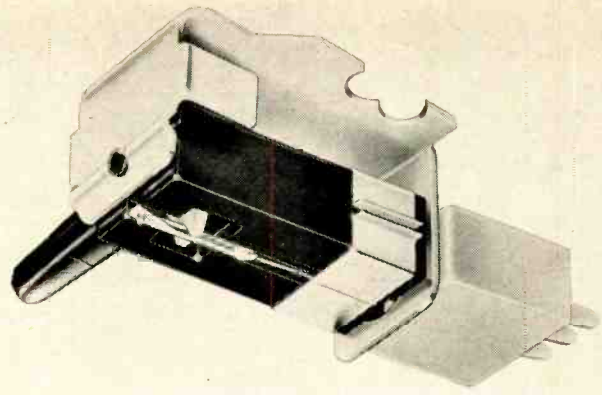

Fig. 3—Ideal RIAA bass characteristic (dotted), against bass equalization with ceramic cartridge and 1,200- μ sec network. Not bad.

network, consisting of capacitance as well as resistance. This network will vary with each cartridge and its values should be obtained from the manufacturer. However, the bulge is not usually big enough to be serious.)

When a manufacturer designs an amplifier for use with a specific ceramic pickup, as in a self-contained phonograph, he provides the correct load resistance. Typically, load resistances are 1 to 3 megohms in self-contained phonographs using ceramic pickups. But, if the user substitutes a different cartridge, there is good chance that the load resistance will no longer be appropriate. If too large, bass will be excessive; if too small, deficient.

The situation is likely to be worse when you feed into an amplifier not specifically intended for use with a ceramic cartridge. Almost always, the high-level input of an amplifier for general use has an input load of $\frac{1}{2}$ megohm, far too small for any ceramic pickup. The result is too much bass cut. Our 1,200- μ sec curve (solid line in Fig. 3) is 3db down at 130 cycles and follows the desired RIAA curve quite closely from there down to very low frequencies. But if the total circuit capacitance is 600 pf and the load resistance only $\frac{1}{2}$ megohm (300- μ sec time constant), bass will start to drop (be 3 db down) at about 500 cycles instead of 130, and be almost gone below 60 cycles.

This problem has two solutions: Increase the load resistance, or increase the circuit capacitance. The second solution has the charm of greater convenience, because it doesn't require going inside

the amplifier. Besides, if you greatly increase the load resistor, you increase the resistance between grid and ground of the first tube, and therefore the danger of hum pickup.

The desirable solution usually is to wire a capacitor in parallel with the cartridge leads. A miniature low-voltage capacitor can be used, making it feasible to mount it right in the tone arm.

How do you calculate the value of the added capacitor? Here is an example. Assume that the cartridge capacitance is 500 pf, according to its manufacture. Because the cable to the amplifier is short, you estimate the other circuit capacitances amount to only 100 pf. Total capacitance is therefore 600 pf. If the load resistance is $\frac{1}{2}$ megohm, and if a time constant of 1,200 μ sec is desired, the total capacitance should be 1,200 divided by $\frac{1}{2}$ which equals 2,400 pf. Therefore it is necessary to add 1,800 pf, this being the difference between the required 2,400 pf and the existing 600 pf. If you want a little more bass to compensate for speaker deficiencies, you might use a larger capacitor, say 2,000 pf (.002 μ f).

Putting a capacitor across the cartridge may have a double advantage. It helps reduce the overall signal level and thus minimizes distortion caused by overloading the amplifier. The equivalent circuit of the various capacitances in our last example is shown in Fig. 4 from the viewpoint of overall signal attenuation. The cartridge forms one leg of a capacitive voltage divider, while all the other capacitances form the second leg. The values in Fig. 4 produce almost 14 db signal attenuation, a reduction to nearly one-fifth of the original level. Considering that ceramic pickups may turn out as much as 1 volt on peaks

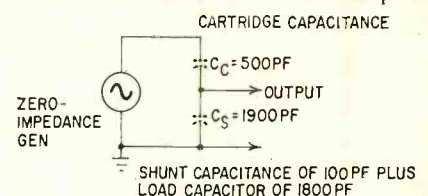

Fig. 4.—Capacitive voltage divider, formed by cartridge capacitance plus stray and deliberate loading, reduces signal voltage.

(some even more), while many an amplifier requires 0.2 volt or less at the high-level input to be driven to full output (some need as little as .05 volt), a 14-db reduction is useful. On the other hand, some ceramic cartridges produce only about 0.2 volt on peaks, while some amplifiers need more than 0.2 volt. In such cases, it may be necessary to increase the load resistance instead of adding a capacitor to obtain full bass response.

Velocity device

As part of the purchase of a ceramic pickup or as an accessory, you can usually obtain from the same manufacturer a plug-in adapter that contains an R-C network to convert the pickup into a velocity device. You plug the cable from the cartridge into the adapter, and plug the adapter into the magnetic input jack of an amplifier.

If you have no adapter, you can transform the cartridge into a velocity device very simply by putting a small load resistor across the cartridge; for ex-

ample, one of 10,000 ohms. This causes the cartridge signal to rise with frequency, in the manner of a magnetic pickup, because the cartridge capacitance in series with the small load resistor forms a high-pass filter throughout the audio spectrum.

However, the transformation is not quite that simple—for two reasons:

As pointed out earlier, the cartridge has built-in treble resonance, which is desirable when it is used as an amplitude device. But the resonance is no longer needed and is undesirable when the pickup is used as a velocity device. To compensate, the signal should rise with frequency only to about 5,000 cycles, leveling off thereafter. That is, the time constant of all the circuit capacitances and the load resistor should be about 32 μ sec.

For example, if the cartridge and other circuit capacitances total 600 pf, the appropriate load resistor in megohms works out to .053 (that is, 32 divided by 600). The nearest standard value of 51,000 ohms would be suitable. The load

resistor across the magnetic input jack of many amplifiers is around this value, for example 47,000 ohms, and such a resistor could do the job if it weren't for problem 2:

The signal from the cartridge is apt to be great enough to overload the phono preamplifier. Therefore it is frequently necessary to reduce the signal voltage by converting the load resistor into a voltage divider, as in Fig. 5. A 10-to-1 voltage division is probably a good starting point.

Because of these two problems, if you intend to use the ceramic pickup as a velocity device, your best course is to buy the adapter made by the manufacturer of the cartridge (unless you are

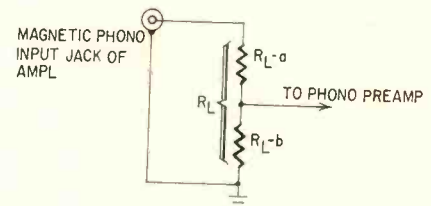

Fig. 5—This circuit converts ceramic cartridge into velocity device. R_L is usually about 50,000 ohms, and R_{L-a} is about 10 times R_{L-b} .

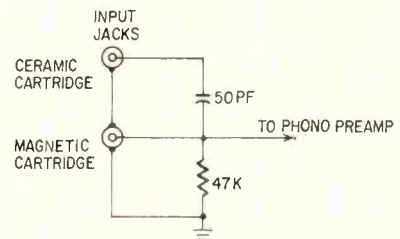

Fig. 6—Many hi-fi amplifiers use this arrangement to make magnetic phono inputs double as ceramic inputs. Capacitor produces gradually rising response.

inclined to experiment). The network in such adapters is usually more sophisticated than the one shown in Fig. 5, providing smoother frequency response.

Some audio amplifiers have a special input jack designed for a ceramic pickup. What they usually do is to feed the signal through a very small capacitor, as in Fig. 6, thus converting the pickup into the equivalent of a velocity device. The capacitor, say 50 pf, together with the usual magnetic load resistance of about 47 to 68 thousand ohms, acts as a high-pass filter that causes response to rise with frequency throughout the audio range. The small value of this capacitor also reduces overall signal output, preventing distortion. However, nothing is done about the cartridge's treble resonance, and the result is overbrilliant response. Thus, if the ceramic pickup is to be used as a velocity device, the best course is to use the adapter designed by the manufacturer of the cartridge rather than by the manufacturer of the amplifier. **END**

Soft-tire Alarm



"Magna-Miler", an electronic low-tire-pressure warning device for heavy-duty vehicles, has been announced by Magnavox. The photo shows the indicator mounted on the dashboard of a trailer-truck cab. Each wheel (inset) is fitted with a tiny mercury-battery transistor transmitter actuated by a pressure switch on the tire valve stem. When the pressure of any tire falls below a preset level, the transmitter radiates a signal through an axle-mounted antenna. The

dashboard warning device picks up the signal and flashes a light or sounds a buzzer.

To find the particular tire, the driver lifts off the indicator receiver and walks around the truck, holding the receiver near each tire in turn. A light on the indicator flashes red when he reaches the soft tire.

Among advantages claimed for the new system are reduced down-time on the road, and elimination of dangerous and wasteful running on soft tires.

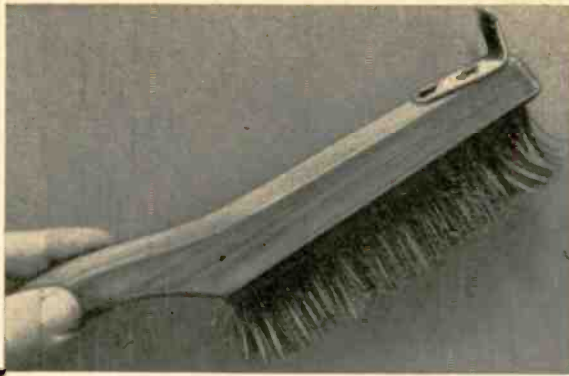

Cleanliness is the first requirement of easy soldering. Make frequent and diligent use of wire brush, sandpaper and scraper to get area to be soldered spotless. For this purpose fasten a small angle on the end of the wire brush and sharpen it for use as a scraper.

Soldering Simplified

By GLEN F. STILLWELL

Keep the tip of the soldering iron bright for best work. A small scrubbing brush mounted on a piece of plywood will help. Steel wool or a thick felt pad also works.

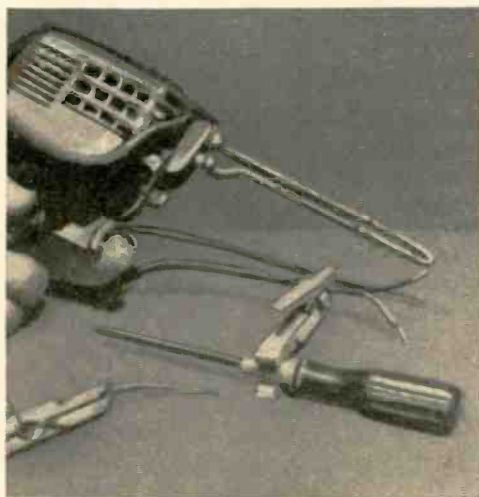
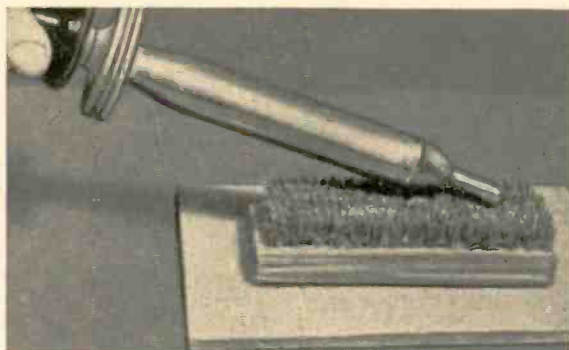

To hold small articles to be soldered use a double-headed clamp made by fastening two spring-type clothespins together, end to end. Wooden clothespins won't cool the work and thus prevent easy soldering. For good soldering, the area to be soldered must be as hot as the iron.



A third hand is often needed in soldering. Make it easy on yourself by winding wire solder on an empty spool which has been fastened with a small bolt and angle bracket, to a wooden spring-type clothespin. An additional clothespin fastened to the first one provides a means of feeding the solder to the iron and there are no burned fingers.

Wrap a length of wire solder around your soldering iron (or gun) cord to prevent it from kinking and possibly wearing and shorting. It has an additional advantage—if you need a bit of solder in a hurry some can be taken from this supply. Wire solder can also be used to keep a coil of insulated hook-up wire and antenna lead-in from tangling, or to take up slack in a drop cord.



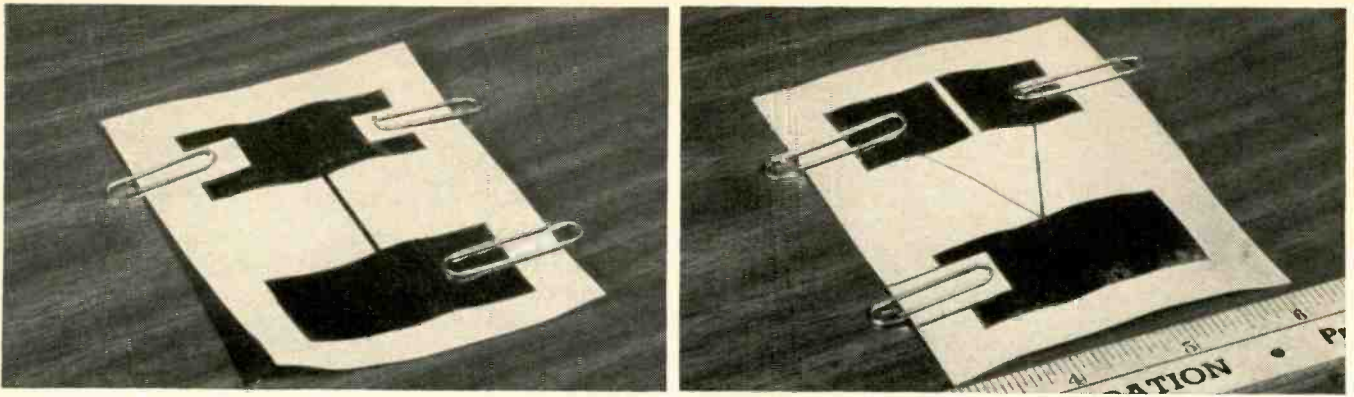

Two views of a scribbled circuit. The paper clips act as contacts to the graphite film. On the right is the "rear" side of the parallel-T circuit.

how to scribble a circuit

Make working thin-film circuits with pencil and paper

By RUFUS P. TURNER

When radio was much younger, we made a grid resistor by drawing a pencil line on a piece of paper and fastening a pigtail to each end. I never completely abandoned the trick. It has often served when I needed a resistor after the stores were closed.

You can make a capacitor the same way. Pencil a solid black square on one side of a piece of paper (this is one plate), then turn the paper over and draw an identical square (the second plate) on the other side over the first square.

This works because a lead pencil mark is conductive. For a given grade of lead, the longer, narrower or lighter the line, the higher the resistance. The shorter, blacker or wider the line, the lower the resistance. Capacitor plates may be made fairly low-resistance by blackening the squares until they shine.

By this simple technique, the experimenter can produce extremely inexpensive thin-film R-C circuits of all kinds. Compared to a printed circuit, this is indeed a scribbled circuit—but it is A-OK, as you can quickly verify.

Component values may be adjusted exactly and in the simplest manner imaginable—with a pencil and eraser.

You try one

No special hard-to-get pencil is needed. An ordinary lead pencil lays the required film of graphite on the paper. However, I find that grade HB is best. (The F's are too soft and the H's too hard.) Just ask for an HB pencil—or for HB leads if you use an automatic pencil.

Use a fairly hard or stiff grade of thin, white paper like that used for better-grade letterheads. The soft kind soaks up moisture more readily and is easily scuffed by the pencil. Carefully fill in all parts of the scribble so that no gray or white freckles remain. Bear down hard, blackening the scribble until it shines like metal.

Resistors For a resistor, draw a straight line, using a ruler or other straightedge. This shape allows easiest adjustment of resistance.

A single, shiny, black line the width of a "thin lead" (.036 inch) has an initial resistance of 300,000 ohms per inch. A similar line $\frac{1}{16}$ inch wide is 7,000 ohms per inch. When you finish, the resistance will probably be too low, but you can increase it by lightly rubbing the scribble with a soft eraser, watching the ohmmeter all the while. If the resistance is too high, blacken the line more or widen it. I have made scribbled resistors from a few hundred ohms to 1,000 megohms.



Test setup used to make the response curve of Fig. 2.

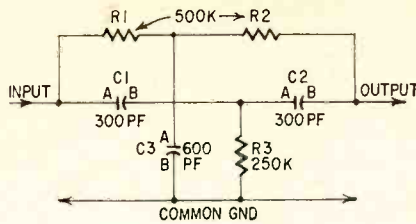
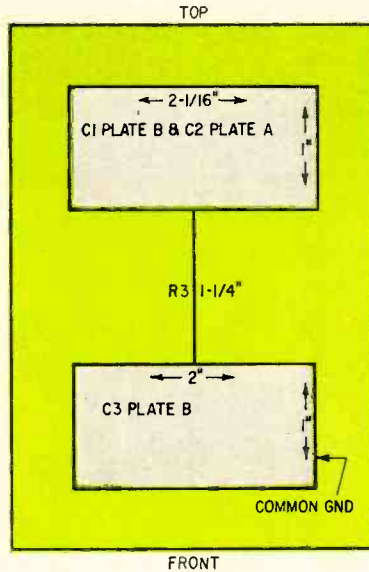
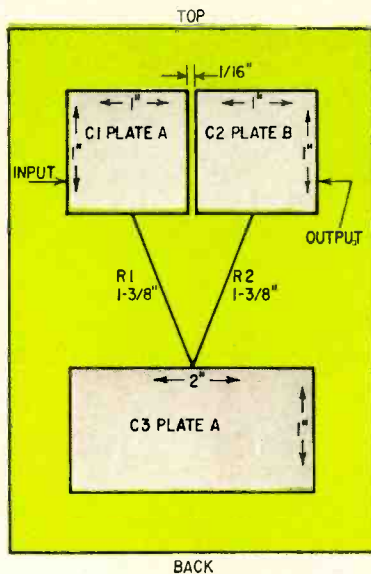

Fig. 1—Details of a scribed parallel-T network.



Capacitors For a capacitor, draw a solid blacked-in square or rectangle on one side of the paper. Then turn over, and draw an exact duplicate on the other side over the first square. Be careful, or much of the first square will be rubbed off. The best precaution is to place the paper on a smooth, hard, highly glazed surface (such as a sheet of glass)—the pencil lead does not transfer readily to such a surface.

The capacitance of this 2-plate capacitor is equal to:

$$C = \frac{kA}{4.45t}$$

where C = capacitance in pf, A = area of one plate in square inches, k = dielectric constant of the paper, t = thickness of paper in inches. The dielectric constant (k) of paper lies between 3 and 6. The average value of 4.5 is a good approximation. To obtain the value of t , you will need to check the paper thickness with a micrometer. If you don't have one, you have an alter-

native—scribe a sample capacitor using 1-square-inch plates, check its capacitance with a bridge or capacitance meter, and use this capacitance (C_s) to determine the size of the capacitor you want. (Capacitance varies directly with the plate area, A —doubling A doubles C , and vice versa. If C_x represents the desired capacitance, then the required area $A_x = C_x/C_s$ in square inches.)

If capacitance is too high, carefully erase a small amount of the scribble, watching the bridge or capacitance meter all the while. Conversely, if capacitance is too low, add a little black area to each plate. I have scribed and adjusted two-plate capacitors from 10 pf ($\mu\mu\text{f}$) to .02 μf .

To be sure, there is a certain amount of Q-reducing resistance in the plate of a scribed capacitor. But this is minimized by making the plate black, shiny and unbroken. In many R-C circuits, this resistance will be insignificant compared to the external resistance connected in series with the capacitor.

Attaching Leads In a scribed R-C circuit, resistor lines and capacitor squares run into each other and provide all connections except input and output terminals. The latter, however, and the pigtails of single (out-of-circuit) resistors and capacitors must be provided.

There are many ways of attaching leads to the graphite film of a scribed circuit. All involve pressure contact. Paper clips are good for temporary connections. If the clip makes unde-

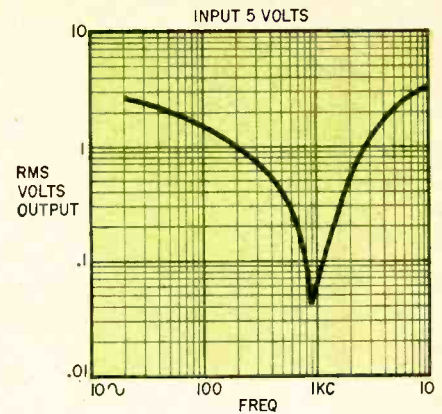

Fig. 2—Measured response of the scribed parallel-T of Fig. 1.

sired contact with a scribed electrode on the other side of the paper, slip a small insulator of paper under it (see photos). Another way is to lay a thin wire pigtail on the scribble surface and tape it solidly in place. Eyelets and pinch type paper fasteners are other possibilities.

Through-connectors Making a connection between electrodes on opposite sides of the paper poses the same problem as with printed circuits. The only entirely satisfactory method seems to be to punch a hole and insert a tight-fitting eyelet.

Protecting After a scribed circuit is completed, spray it with Krylon or a similar protective coating.

Packaging Scribed circuits can range from postage-stamp size up. They may be used flat, mounted for protection and rigidity between cardboard or plastic cards. Or for convenience, some of them may be rolled up, like a tubular capacitor, provided a paper or cellophane "skin" is laid on each side to prevent short circuits—and only if the rolling does not bring the plates of separate capacitors opposite each other. After tightly rolling, bind the unit with tape, or pot it, if you like.

Typical circuit

Fig. 1 shows a scribed version of the immensely useful parallel-T null network. This thin unit takes the place of three capacitors and three resistors.

Fig. 2 shows its measured frequency response. In this circuit $C1 = C2 = \frac{1}{2}C3$. This accounts for the larger size of $C3$ in the drawing. Since $C1$ and $C2$ are connected, their plates are scribed as a single large plate on the top surface of the paper to provide a simplified connection. In this circuit also $R1 = R2 = 2R3$. The null frequency $f = 1/(6.28RC)$.

Many other R-C circuits can be scribed. Your only task (and it is an interesting one) is to locate the electrodes in the proper position and on the correct side of the paper. END

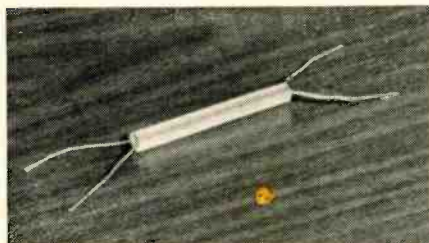

This circuit, a three-section low-pass R-C filter, is rolled up to reduce its size.

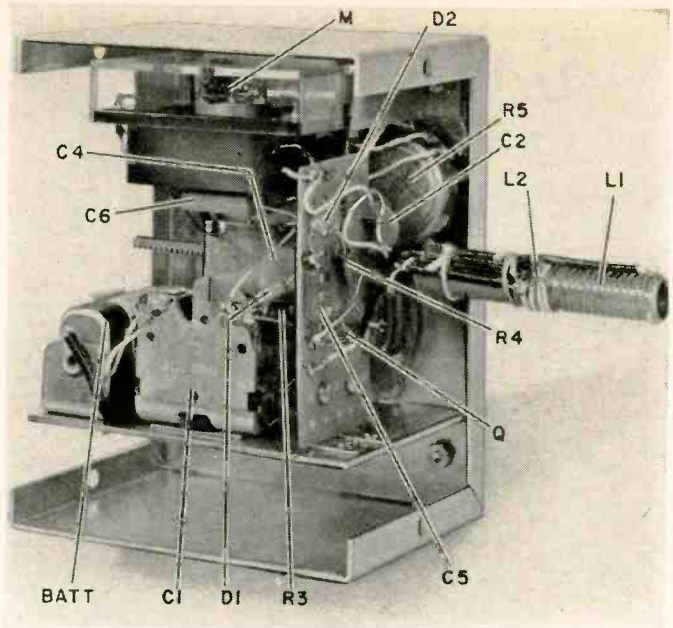
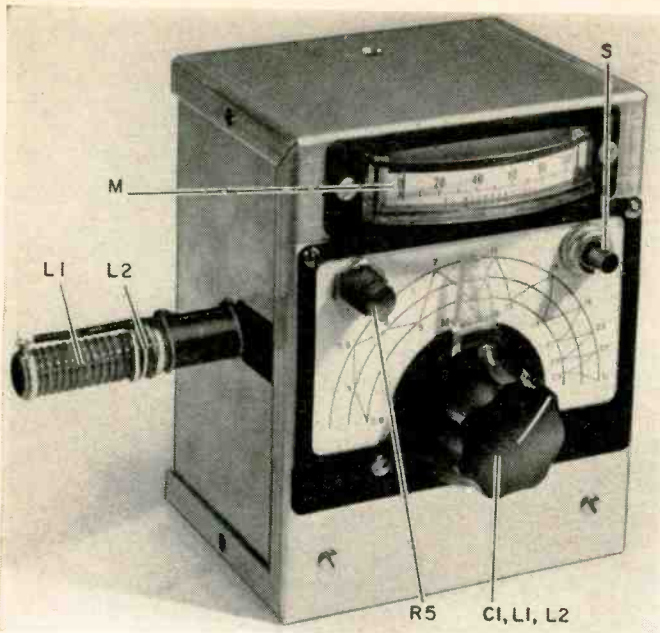

Front panel view (left) of the completed instrument, and (right) a peek inside the case. If you don't use an edgewise meter, you'll have to get a larger case.

COVER STORY

base-dip oscillator

1-transistor unit checks coil-capacitor networks in a hurry.

By ROBERT F. SANFORD

This unique, transistorized instrument is an up-dated version of the familiar grid-dip oscillator used by hams, experimenters and engineers. It departs from the usual grid-dip oscillator in two ways. First, it is completely transistorized. Second, the novel tuning system eliminates plug-in coils. The single-range dial reads from 2.8 to 31mc. Because of its construction, I call the instrument a base-dip oscillator (bdo).

Like a gdo, this unit can be used to find resonant frequencies of tuned circuits, align circuits without turning on the power, identify parasitics, check antennas for resonance, and tune traps and filters. In a pinch it can also be used as a signal generator or a sensitive

tuned rf detector.

As a resonant circuit placed near the bdo's oscillator tank circuit is tuned to the same frequency, the level of oscillation will change. This change can be noted by reading the current flowing in the oscillator's control circuit. In vacuum tubes, a reliable measurement is the control-grid current. With transistors, the base voltage is measured. Therefore, as the oscillator tank circuit is placed near another tuned circuit at the same frequency, the current flowing in the base circuit is decreased, thus the name "Base-Dip Oscillator."

A simple, straightforward transistor circuit is employed (Fig. 1). The oscillator is an Armstrong type, one of the most easily adjusted circuits. Feedback necessary for oscillation is rea-

sonably constant over the entire frequency range, reducing the adjustments needed to keep the meter within its range.

Bias is supplied to the transistor through coil L2, bleeder system R1 and R2. C2 bypasses the cold end of L2 to

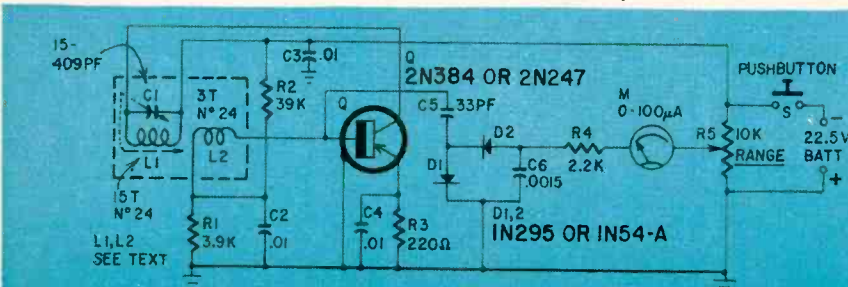

Fig. 1—Circuit of the simple instrument.

- R1—3,900 ohms
- R2—39,000 ohms
- R3—220 ohms
- R4—2,200 ohms
- R5—pot., 10,000 ohms
- All resistors 1/2-watt 70°
- C1—15-409 pf variable (A midget trf type unit carried by Allied Radio under their part number 61H009. Equivalent units may also be used. Adjust holes in coil bracket to suit.)
- C2, C3, C4—.01 µf, disc ceramic
- C5—33 pf mica
- C6—.0015 µf, mica
- BATT—22.5 volts (RCA VS084 or equivalent)
- D1, D2—1N295 or 1N54-A
- L1—15 turns No. 24 enamelled wire (see text)
- L2—3 turns No. 24 enamelled wire on cold end of L1 (see text)
- M—100-µa dc meter (Simpson model 1502 or equivalent)
- S—5-spst pushbutton (N.O.)
- V—2N384 or 2N247
- Mechanical parts:
 - Gear part No. G-144, \$1.74. Rack part No. G-586-48P, \$1.96 per ft. (Standard length 2 feet), Boston Gear Works, 14 Hayward Street, Quincy, Mass. (Equivalents may be obtainable from local mechanical components firms.)
 - Bakelite tubing—1/2-inch o.d., 4 1/2 inches long, 1/16 inch wall.
 - Bakelite block—1 inch long, 3/4 inch wide, 3/8 inch high.
 - Plexiglas rod—3/8 inch diameter, 1/4 inch long.
 - Bracket material—3 x 1 x 1/16-inch soft brass.
 - Ferrite rod—2 inches long, 3/8 inch diameter.
 - [Broadcast-band transistor radio antenna rod or Part No. Q-2, CF-502 from General Ceramic Corp., Keasbey, N. J.]
 - Dial—National Radio model MCN
 - Case—to suit
 - Miscellaneous hardware

provide the ac ground. Temperature stability of the collector current and a wide range tolerance of the battery voltage is provided by R3 with C4 bypassing the emitter to ground. You should have no difficulty getting the oscillator to work properly but, if the unit does not oscillate, try reversing the leads of coil L2.

The meter circuit is unusual in that it has full sensitivity regardless of the level of oscillation or setting of RANGE control R5. It is in a bridge circuit with R5 acting as one side of the bridge and the base detector circuit acting as the other side. The detector measures the rf voltage on the base of the transistor, giving a dc output proportional to the level of oscillation. A similar voltage is obtained by adjusting the potentiometer. Thus, when the meter is set within range, a small change in the level of oscillation is indicated by a large downward reading of the meter when the tank circuit is externally loaded by a tuned circuit.

The detector network is a voltage doubler, comprising diodes D1 and D2 and capacitors C5 and C6.

Construction details

To build the bdo, start with the mechanical assembly. I used a 3 x 4 x 6-inch aluminum box as chassis and case. The photos show the location of all parts.

The key point in the novel tuning

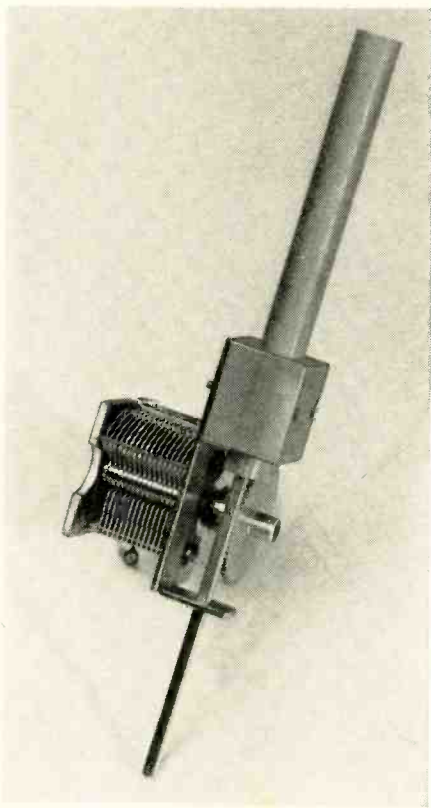

The completed tuning assembly. When the tuning knob is turned, the capacitor plates rotate and the ferrite core moves up and down.

This angle shows how the tuning assembly is mounted in the case.

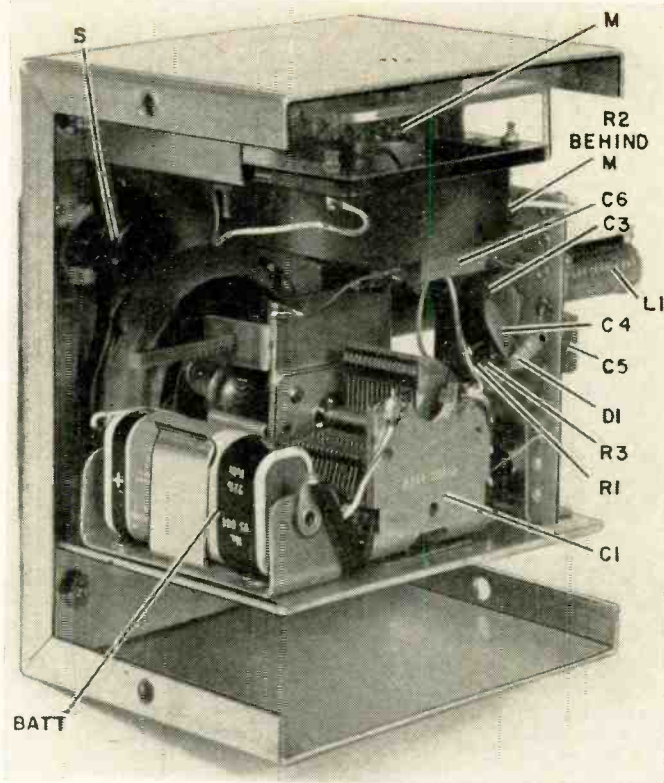
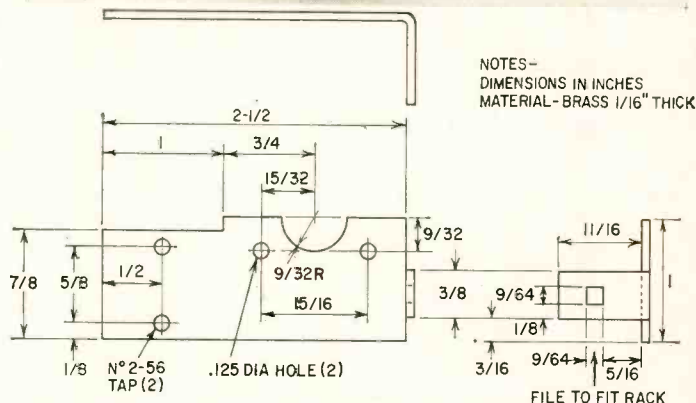

Fig. 2—Bracket for the tuning capacitor—coil arrangement.



NOTES—
DIMENSIONS IN INCHES
MATERIAL—BRASS 1/16" THICK

arrangement is the simultaneous tuning of both capacitance and inductance of a resonant L-C circuit. The simplest method of varying the inductance of a coil is to slip some paramagnetic material such as a ferrite core (to increase inductance) or some diamagnetic material such as a brass core (to decrease inductance) in and out of the coil form. I used a 1½-inch length of ⅜-inch-diameter ferrite core cut off the end of a standard broadcast-band transistor radio antenna rod.

To tune inductance and capacitance simultaneously, the shaft of the variable capacitor must be coupled

mechanically to the movable ferrite core that is to be inserted and withdrawn from the coil form. Very positive tuning can be obtained with a rack-and-gear assembly that converts the rotary motion of the shaft to the necessary linear motion of the core material. The tuning mechanism has five parts or subassemblies: (1) rack guide and coil support bracket, (2) rack and slug assembly, (3) oscillator coil and supporting block, (4) gear, (5) capacitor.

The brass bracket (Fig. 2) is designed to fit on the shaft end of the tuning capacitor. The coil assembly fits on

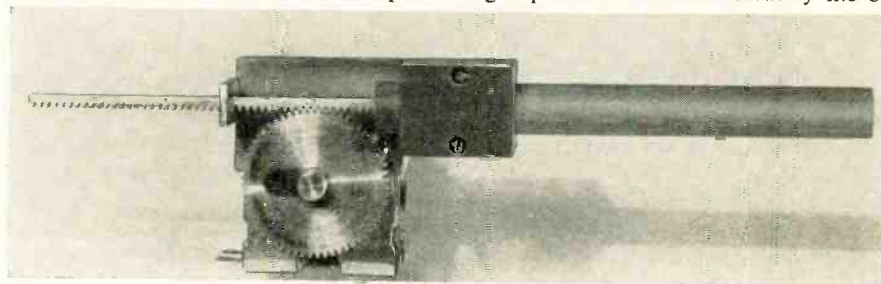

Another look at the tuning assembly.

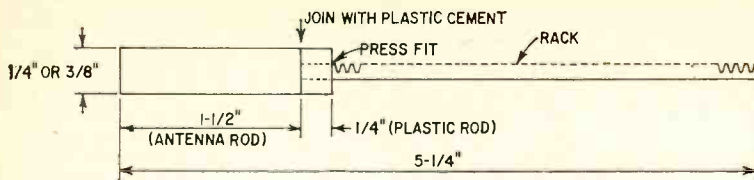

Fig. 3—Rack is cemented to ferrite core.

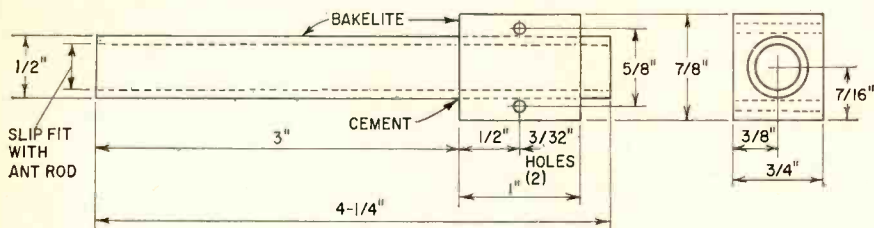

Fig. 4—Details of the coil-form assembly.

the flat portion of the bracket while the tab with the square hole guides the rack during the in-out travel of the slug assembly. This guiding action gives a second point of support to the rack end of the assembly, assuring a constant mesh between the rack and gear and keeping backlash to a minimum.

The ferrite slug and rack are joined into an assembly (Fig. 3) by a simple home-made plastic coupler. It is made by forming a hole in the center of a 1/4-inch long, 3/8-inch diameter piece of plastic into which the rack is press-fitted and cemented. The ferrite core is then cemented end to end with the plastic piece, thus completing the slug and rack assembly.

The coil-form assembly (Fig. 4) consists of a 1/2-inch bakelite tube mounted in a 1-inch long bakelite block which has been drilled to accept the tubing. The assembly is mounted with two 4-40 screws to the bracket in such a way that the center of the tubing and square guide hole on the tab of the bracket are coaxially aligned.

Final assembly (Fig. 5) of the tuning unit is best done this way: With the gear in place on the capacitor shaft, insert the ferrite rod-rack assembly through the coil form with the rack meshing the gear and through the square hole in the tab of the bracket until the plastic coupler nearly touches the gear. Then rotate the capacitor to its fully open position and tighten the gear setscrew. Next, with the capacitor plates fully meshed, adjust the coil form in and out of the mounting block so that its end is flush with the end of the ferrite rod. Then cement the coil form in place. Now check for backlash. If excessive, eliminate by adjusting the bracket so the rack presses more firmly into the gear.

Coil L1 is made up of 15 turns of No. 24 enameled wire evenly spaced for 1 1/2 inches, starting at the extreme outer end of the tubing. Ends of the winding are held by cementing or dop-

ing the wire to the coil form. Remember, the interior of the tubing must be kept completely clear as the ferrite slug travels the whole length of the tubing. A 3-turn link (L2) is wound in the same direction and in between 3 turns of the main coil at the capacitor end.

Circuit layout and wiring is straightforward and parts placement is not critical. Keep interconnecting wires as short as possible. Use a phenolic board (1 1/4 x 1 1/2 inches) supported by two brackets for mounting most of the circuit components. As you can see in the photos, the board is mounted on the coil side of the variable capacitor and space for mounting the circuit components is left on either side of the pheno-

lic board. Connect the meter, battery, switch, potentiometer and tuning unit to the circuit board with short insulated leads.

Calibration

There are two ways of calibrating the oscillator. The best method is to use a good communications receiver tuned to the calibration points and then tune the bdo to the same frequency. The second method is to use a good grid-dip-meter in the monitor mode of operation, dipping the bdo to find the calibrating frequencies. If you use this method, avoid pulling the frequency of the bdo by coupling very lightly between the two units.

END

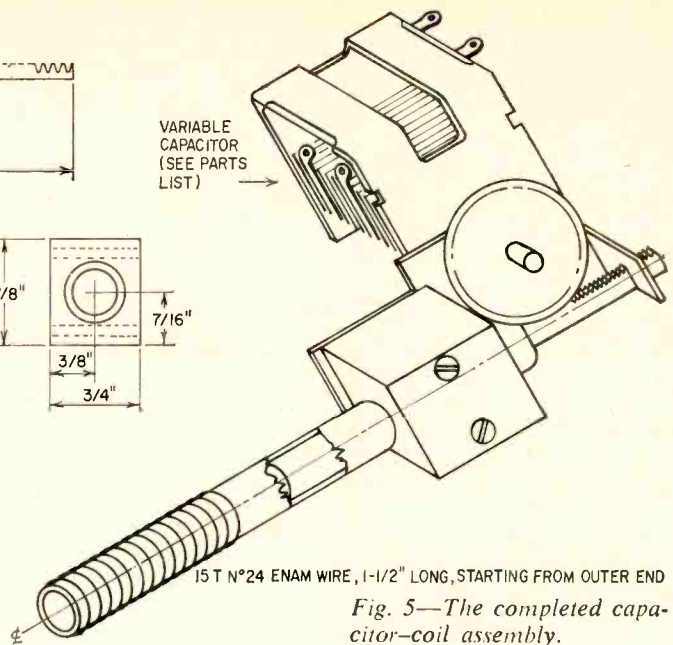
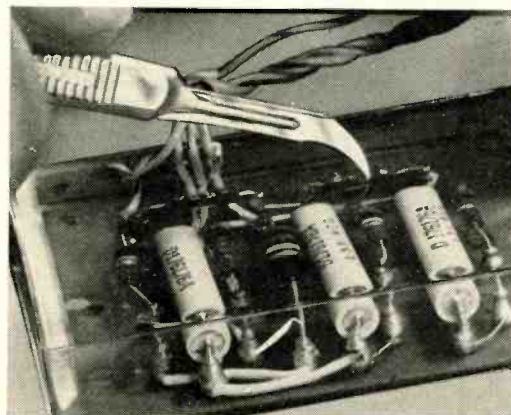

Fig. 5—The completed capacitor-coil assembly.

transparent encapsulators



MANY ELECTRONIC CIRCUITS REQUIRE encapsulation—potting. It protects them against high humidity, dust, grime, etc. However, many potting compounds have one great fault—once the circuit or component has been potted, it cannot be repaired. There is just no way of locating the component covered by an opaque protective coating and getting it out for repair. It's like trying to find a pebble cast into a brick!

But now things are different. A

transparent potting compound is available. Made by Dow Corning, it is called Sylgard 182. It sets in 15 minutes at 150°C, in 3 days at 25°C. Its most important feature is shown in the photo. You can see just where every part in the circuit is located. And if one needs replacement, take a sharp knife and cut away the encapsulating material. Then replace the defective component, pour in some new Sylgard 182, let it set, and you're back where you started from.

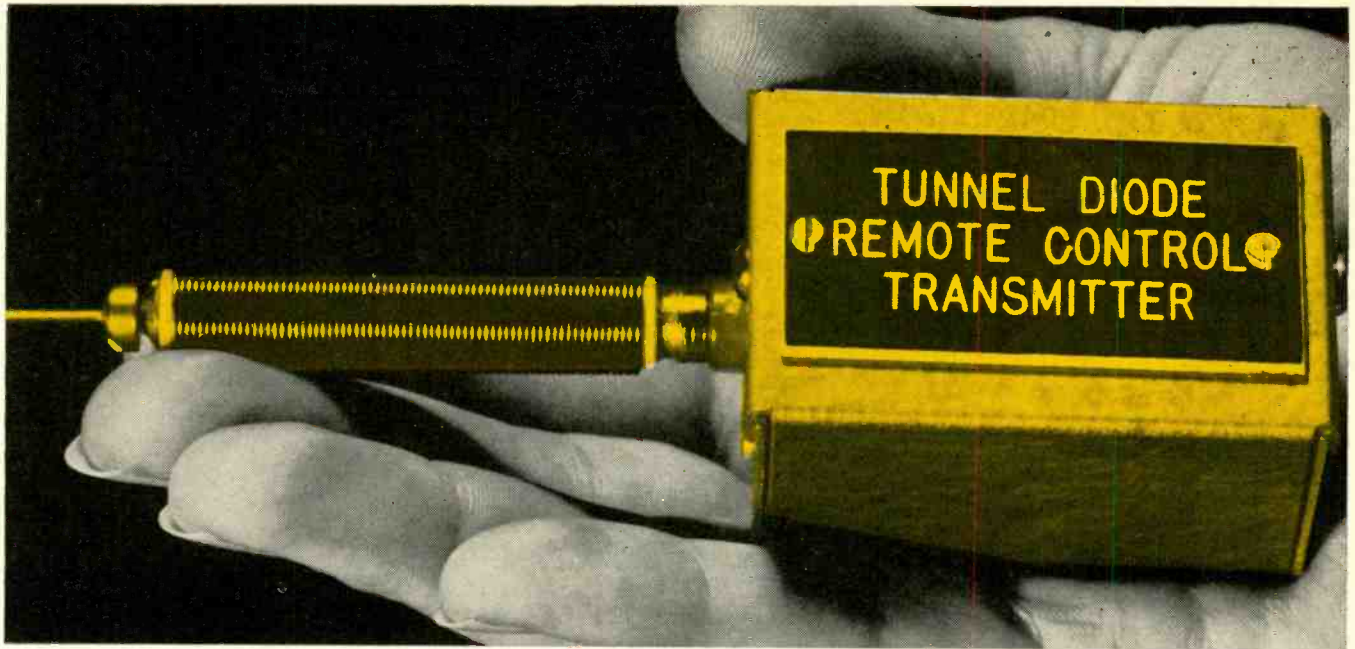

Tiny tone-modulated R/C transmitter has 75-foot range

By **JOHN F. CLEARY** and
ERICH GOTTLIEB*

THE TUNNEL DIODE HAS RECEIVED A great deal of publicity in the 4 years since its invention. First, glowing reports on its future had it advertised as the answer to all prayers. As commercial devices became available, the circuit designer soon found that, without a really good understanding of the tunnel diode's operation, he was unable to make it perform any function stably. His first experimental amplifier was oscillating, and conversely his first oscillator was amplifying!

The years 1960 and '61 saw a number of articles explaining some of the intricacies in the tunnel diode's behavior, and produced the first tunnel diode manual.¹

One of the most attractive uses of the tunnel diode is in low-power oscillators. Here it excels because of its small size, low power requirements and extreme circuit simplicity. Its excellent frequency stability, an important asset

for oscillator usage, has been illustrated in a two-part article in *Electronic Design Magazine*.² The article pointed out that a simple series-parallel tunnel-diode oscillator circuit could provide very stable sine wave oscillations even when subjected to large variations of temperature and voltage. The three remote control transmitters discussed in this article use such an oscillator, with stability further improved by a quartz crystal.

These 27.255-mc transmitters were designed to operate as portable garage-door openers in conjunction with a five-transistor superregenerative tone-select receiver ("CB Receiver Opens Garage Door," January 1963, page 26). With this receiver the transmitters have a range of around 75 yards.

The circuit

The basic circuit in Fig. 1 is unique in that it uses a single tunnel diode to oscillate both at 27.255 mc and at 1,300 cycles. It is self-modu-

lating. A tunnel diode can oscillate at several frequencies simultaneously with appropriate tank circuits having greater impedances than the negative resistance of the tunnel diode. All one need do is to bias it (from a low-resistance dc voltage divider) in its negative-resistance region. This means that for the 1N3716 (4.7 ma) diode in Fig. 1, the bias is set at about 130 mv and 2.5 ma by R1 and R2. The voltage from the 1.34 volt mercury cell is dropped to 130 mv by R1 and R2. Under these bias conditions, the tunnel diode, in conjunction with C2, L1 and C3 (the tone oscillator circuit) and L2, C4 and the crystal (27.255 mc), will oscillate at those frequencies. Modulated output is coupled by C5 to the whip antenna. C1 is an rf bypass across the bias supply. The photos show parts placement for the circuit of Fig. 1.

Although this circuit is attractive, experiments showed that the tunnel diode oscillates harder at the audio-tone-frequency than at the rf carrier frequency and that this simple circuit has a tendency to "unlock". This results in "sideband splatter" over too wide a frequency range and possible violation of the FCC Rules and Regulations governing interference. A separate audio oscillator allows one to feed just enough modulation power to the rf oscillator to limit the necessary side-band power and still attain the required range, but without "sideband splatter." Two such circuits are shown in Figs. 2 and 3. In Fig. 2, a 2N2840 unijunction transistor operates as a relaxation oscillator providing positive pulses to modulate the crystal-controlled tunnel

* Application Engineering Semiconductor Products Dept., General Electric Co., Syracuse, N. Y.

¹ General Electric Tunnel Diode Manual, First Edition

² Erich Gottlieb, "Tunnel Diode Sinewave Oscillators", *Electronic Design Magazine*, Aug. 2 (pp. 40-45) and Aug. 16 (pp. 52-55), 1961

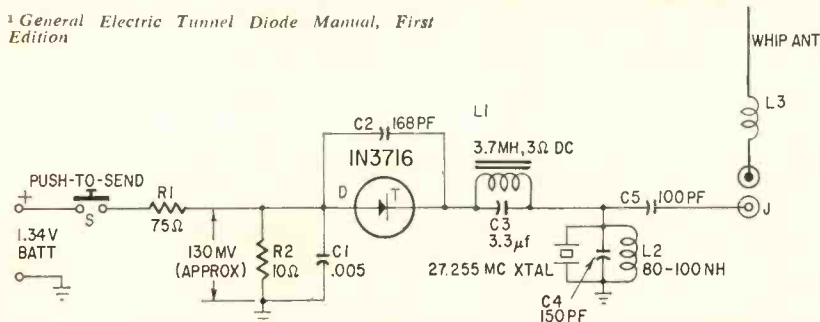

Fig. 1—Circuit of self-modulated tunnel-diode transmitter.

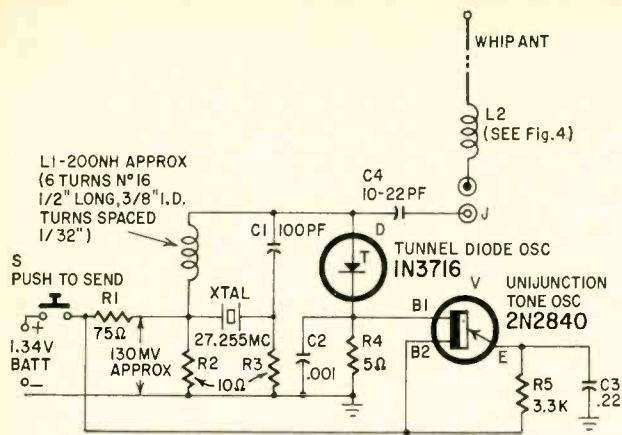

Fig. 2—Transmitter with unijunction modulator.

Parts list (for Figs. 2 and 3)

- R1—75 ohms
- R2, R3—10 ohms
- R4—(Fig. 2) 5 ohms
- (Fig. 3) 1 ohm
- R5—(Fig. 2) 3,300 ohms
- (Fig. 3) 10,000 ohms
- R6—47 ohms
- C1—100 pf molded mica
- C2—.001 μ f ceramic or paper
- C3—0.22 μ f paper or Mylar
- C4—10 to 22 pf mica or ceramic
- C5—0.15 μ f paper or Mylar
- L1—200 nanohenries, 6 turns No. 16 Formvar or enameled wire, 1/2 in. long, 3/8 in. inside diameter. Turns spaced 1/32 in.
- L2—Part of antenna. See Fig. 4
- D—IN3716 4.7 ma tunnel diode (G-E)
- V—2N2840 (Fig. 2), 2N2712 (Fig. 3)
- J—pin jack
- S—subminiature momentary spst (N.O.)
- T1—output transformer, 500 ohms ct. to 3.2 ohms (UTC SO-9 or equiv)
- Xtal—crystal, 27.255 mc (PR type Z-9R, Texas type HC-6/U or equiv)
- Batt—1.34-volt mercury cell
- Case—2 1/4 x 1 1/2 x 1 3/8 in. (LMB No. M00 or equiv)
- Banana jack (E. F. Johnson No. 108-771)
- Banana plug (E. F. Johnson No. 108-760)
- Pin plug (E. F. Johnson No. 105-301)
- 1/2 x 1 1/4 in Teflon or polystyrene solid coil form.
- No. 24 enameled or Formvar wire

diode oscillator. The tone frequency is a function of the time constant of C3, R5 and the unijunction characteristics, while R4 determines the modulation index. Since the modulation is in the form of short pulses, the duty-cycle of the modulated envelope is low, insuring against "sideband splatter".

This tunnel diode crystal oscillator, developed by R. L. Watters,³ is extremely stable and will oscillate only at the series-resonant-mode frequency of the quartz crystal.⁴ Locking action is unusually positive when the oscillator loading is not too heavy.

The circuit in Fig. 3 uses the same crystal oscillator but sinusoidal modulation is provided by a 2N2712 transistor used in a Hartley oscillator. Modulation percentage is again controlled by R4.

Construction

The 27-mc tank coil (L1 in Figs. 2 and 3) has an inductance of approximately 200 nanohenries. It consists of 6 turns of No. 16 enameled wire air-wound with an inside diameter of 3/8

³R. L. Watters, "A Quartz Crystal Chronometer", *Electronics*, Sept. 29, 1961, pp. 129-131.
⁴E. Gottlieb, "Tunnel Diode Oscillators—Don't Sell Them Short", *Electronic Design*, March 1, 1963, pp. 68-71.

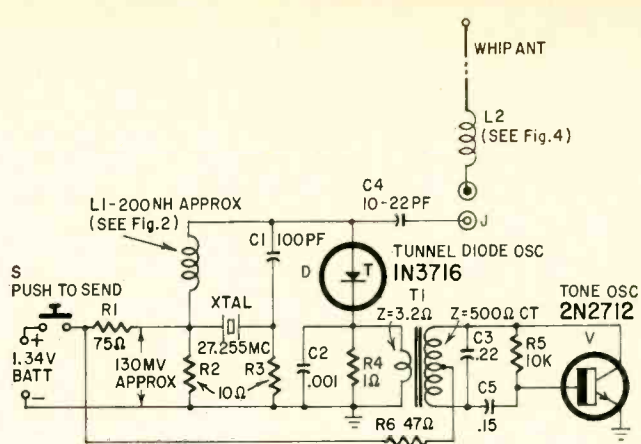

Fig. 3—Hartley oscillator supplies control tone in this circuit.

inch and an overall length of 1/2 inch. Turns are approximately 1/32 inch apart. The tank circuit L1-C1 is not grounded as in Fig. 1. It is positioned parallel with the crystal holder and the chassis top, and on the opposite side of the antenna jack. One end of the coil runs directly to the outside crystal terminal while the other is held rigidly in place by C1, C5, and the tunnel diode. The transformer in Fig. 3 (UTC type SO-9) is secured in place with contact cement.

Since the tunnel diode will oscillate at more than one frequency, short connecting leads are important. All capacitors are fixed so that the inductance must be spread or squeezed to lock the diode to the crystal frequency. Depending on stray capacity and inductance present, some cut and try around the values given may be required.

The battery holder must be cut down if it is to fit into the case. This is a "tailoring" job and requires the removal of both metal solder terminals as well as cropping the bakelite base as close to the battery as possible. This also is clearly shown by the photographs. Not shown is the single 4-40

screw securing the holder, from the bottom, in place. Be sure the screw is so located as to avoid a short circuit with the holder terminals.

To insure a common low-impedance point for all grounds, line the inside-top of the box chassis with a small piece (1 1/8" x 1 1/4") of sheet copper. This is held in place by the antenna jack and crystal holder. All ground returns are soldered directly to the copper.

The transmitters in Figs. 2 and 3 were built into the same box chassis as Fig. 1. Location of the crystal (PR Type Z-9R, Texas Type HC-6/U or equivalent), battery holder, switch, and the antenna jack are identical for all units. Since coil L1 of Fig. 1 is not used in the transmitters in Figs. 2 and 3, the additional space provides plenty of room for the respective modulator components.

Antenna

Since only microwatts are available to the antenna, and since a transmission range of at least 75 yards was desired at the outset, a short vertical antenna was all but useless. Adding L2 as

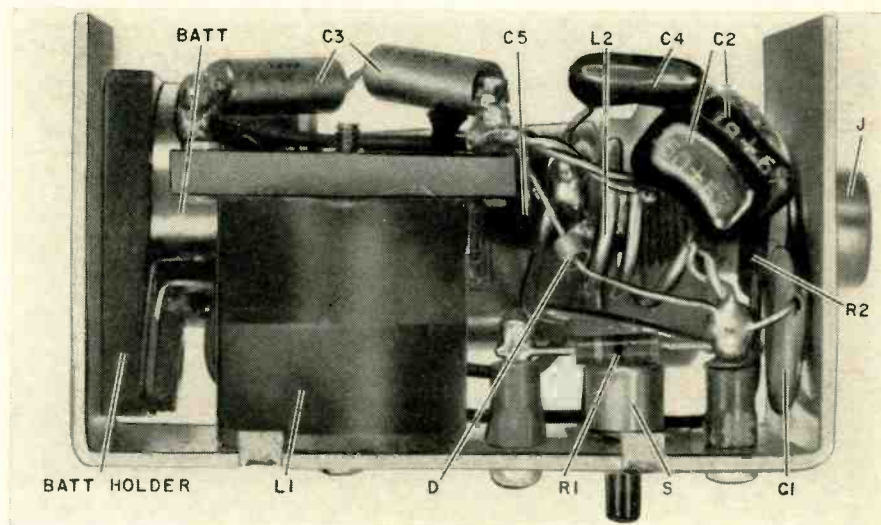

Side view of transmitter in Fig. 1. Tone oscillators in Figs. 2 and 3 fit into space occupied by L1.

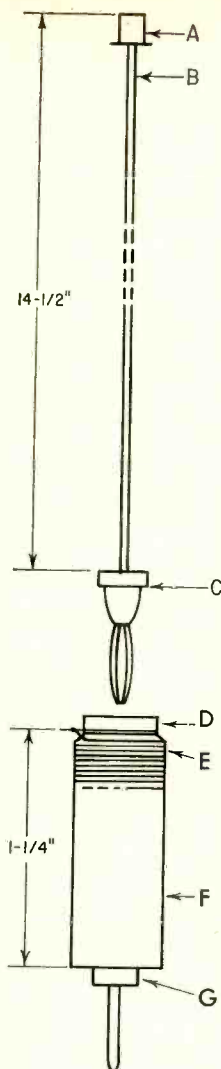

Fig. 4—Details of antenna and loading coil construction.

- A—Safety cap soldered to antenna tip.
- B—1 4 1/2 - inch length of .052 piano wire soldered or brazed to C (E. F. Johnson 108-771 banana plug).
- D—Banana jack (E. F. Johnson 108-760 force-tapped into 7/32-in. hole).
- E—Coil, 50 turns No. 24 Formvar or enamel covered wire adjusted to 27 mc with grid-dip meter.
- F—Solid coil form 1/2 x 1 1/4 in. Teflon or polystyrene.
- G—Tip plug (E. F. Johnson 105-301) force-tapped into 7/32 hole.

a loading coil (in Figs. 2 and 3) to the existing straight wire gave a dramatic increase in range. Total antenna length is a compromise of ease of handling, transmission range and safety to bystanders as well as the operator.

Antenna construction is straightforward as shown in Fig. 4. This is easier to construct than the earlier one shown in the photograph. L2 consists of 50 turns of No. 24 Formvar (or enamel) wire tightly wound on a 1/2 x 1 1/4-inch polystyrene, Teflon or equivalent insulator. After securing and soldering to each end lug, clip off the lug ends and file the rough edges smooth. A drop of cement at each end of the coil prevents loose wires.

Conclusions

Total current drain from the 1.34-volt mercury cell is 12 ma for the circuit of Fig. 1. With the intermittent type of operation normally encountered in remote control applications, such as opening a garage door, excellent battery life can be expected with this battery, rated at 1,000 milliampere hours. The circuit of Fig. 2 adds only 0.5 ma, while the circuit of Fig. 3 draws an ad-

ditional 4.0 ma.

As a result of crystal control, excellent frequency stability can be expected in the circuits of Figs. 2 and 3. Even without the crystal, surprisingly good stability will result from tunnel-diode oscillators if all electrical stability requirements have been met, good engineering construction practices have been followed, sufficient circuit shielding is used, and antenna coupling is loose. Hand-held tunnel-diode oscillator transmitters, both AM and FM, have been designed and constructed for higher-frequency operation. Line-of-

sight transmission ranges of 200 yards or more have been achieved.

There is no reason why this simple transmitter could not be designed for more complex remote control functions. Two possibilities that come to mind are two or more continuous audio tones modulating the carrier. An AM-FM duplex type of operation using a single tunnel diode is not inconceivable. By substituting a microphone and a one-transistor preamp (such as shown on page 41 of reference 1) for the tone network, the transmitter can be voice-modulated. END

those crazy values

By RICHARD H. DORF*

IF YOU WORK WITH ELECTRONICS regularly, you know that, if you want a resistor one size larger than 47,000 ohms, it will turn out to be 56,000. But have you ever wondered why such odd numerals as 10, 12, 15, 18, 22, 27, 33, 39, 47, 56, 68, and 82 (followed by various quantities of zeroes) are used for resistor values? Offhand, it would appear that a highly influential but totally inebriated government official settled on these figures at about 4 AM after a night of cards and women, and the electronic world has been stuck with them since.

But the fact is that they make much more sense than the values before the last (big) war. They were nice, round figures like 10, 20, 30, 40, you remember. Today resistors are better than ever, and so are the values. If you are old enough to remember 1941 and before, the resistors were almost twice today's size, and the rough, uninsulated surface was covered with three colors of paint, which you read for a value in a body-end-dot sequence. Today's 1/2-wattors are only 3/8 inch long and 1/8 in diameter, beautifully cylindrical, totally insulated, and neatly marked with four shiny colors in obvious sequence for the value and tolerance. Incidentally, they're more stable, moisture-proof and heat-resistant.

But those crazy values! Well, they're not so crazy. They are designed to help the engineer and technician find a standard resistor that will come within 10% of any value which a circuit may need.

Consider the old values, and let's talk about 20% tolerance, since that's how they were made. A 1,000-ohm resistor with its plus tolerance might be as high as 1,200 ohms. The next size, 2,000 ohms, might be as low as 1,600. But

there was a gap between 1,200 and 1,600 where you couldn't get a standard value that would give you a resistance guaranteed within $\pm 20\%$ of nominal. At the other end of the scale, a 9,000-ohm resistor with its -20% tolerance might be as low as 7,200 ohms; an 8,000-ohm unit with its $+20\%$ might be as much as 9,600 ohms. So in that range it would make little difference which of two or three different values you used, meaning that too many values were available!

The modern values are chosen so that the $+10\%$ tolerance of any value slightly overlaps the -10% tolerance of the next higher standard value. For instance, 39,000 ohms $+10\%$ is 42,900 ohms. 47,000 -10% is 42,300 ohms. You will find about the same overlap between any two modern values. Since the values now proceed approximately according to a geometric progression (each value is about 1.2 times that of the next lower one), percentage tolerances have about the same meaning and the same effect on circuit performance (which is generally affected in percentage terms and not arithmetically) at any value of nominal resistance.

The capacitor manufacturers also have tried to standardize on these values (.01, .012, .015, .022, etc.) but for some reason they have had less success. Perhaps it is because in most circuits exact capacitor values have less effect than resistor values. Except in tuning and timing circuits, few designers would bother with choosing between .012 or .015 μf . If .01 μf weren't right, their next normal step would be to try .022. So full use of new values would be unnecessary.

So if you haven't already done it, memorize these numbers: 10, 12, 15, 18, 22, 27, 33, 39, 47, 56, 68 and 82. That's the price you pay for the benefits of better resistor values! END

*President, Schober Organ Corp.

music all over the house —without wires

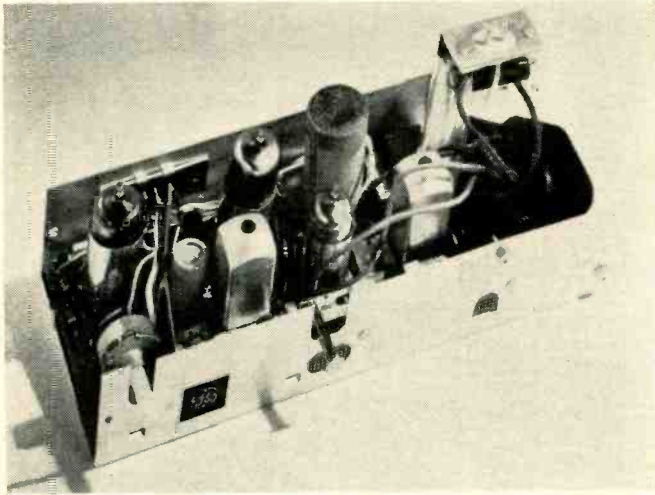

Transmitter chassis uses many parts that are the same as those used in home receivers.

Two new units pipe sound from TV, phono or radio all over home

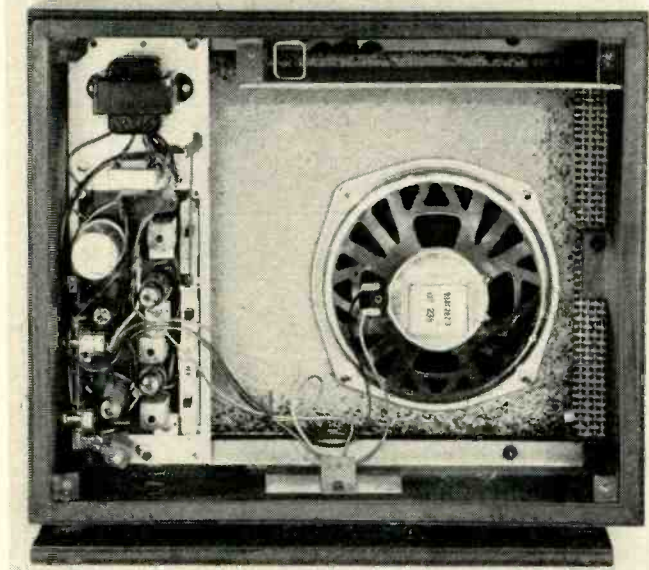

Larger speaker-cabinet volume gives better tone than possible from 4-tube table radio.

HOME MUSIC DISTRIBUTION SYSTEMS ARE slowly but surely gaining popularity. Several manufacturers of built-in intercoms now have one or more models that include radio and phono as well. Two radio-TV manufacturers have followed the trend and have developed home music distribution systems as accessories for their sets. The Westinghouse *Mobil Sound* is a wireless system that radiates the TV audio signal to any broadcast receiver in the house. The G-E *HMDS* (Home Music Distribution System) uses an FM carrier-current (wired-wireless) transmitter and special receivers.

The G-E system

This consists of the SP30 transmitter and SP20 receiver. It operates on either 250 or 300 kc, and can be changed from one channel to the other by flipping a switch on the transmitter and receiver. The alternate channel is used to avoid interference with a neighbor's HMDS system.

Fig. 1 shows the circuit of the transmitter. Two jacks are provided for

(Photos General Electric Co.)

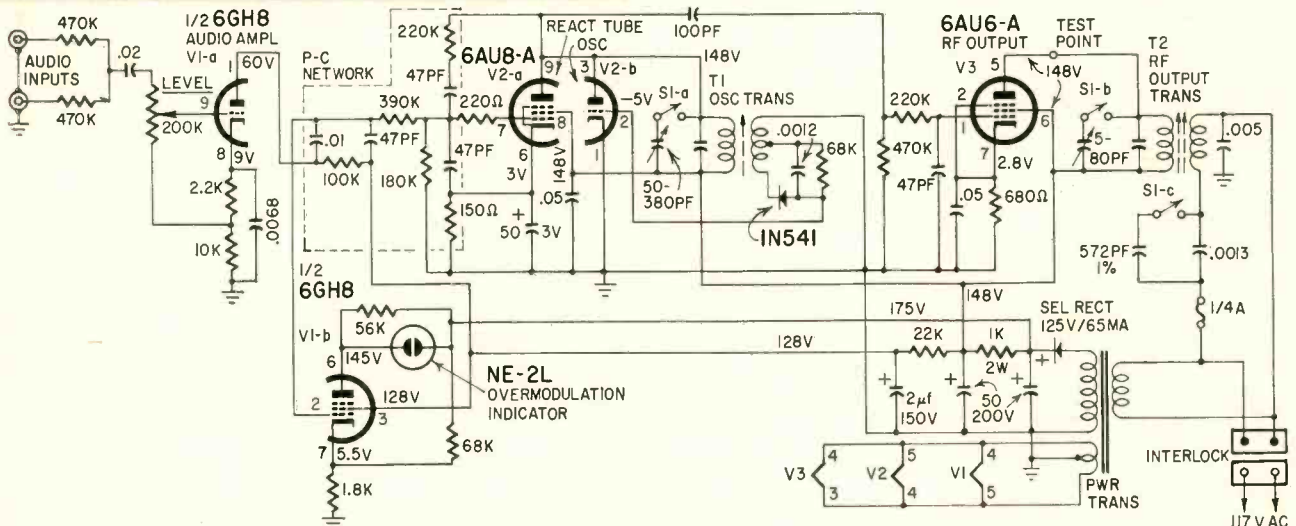

Fig. 1—Simple transmitter circuit feeds output into power line.

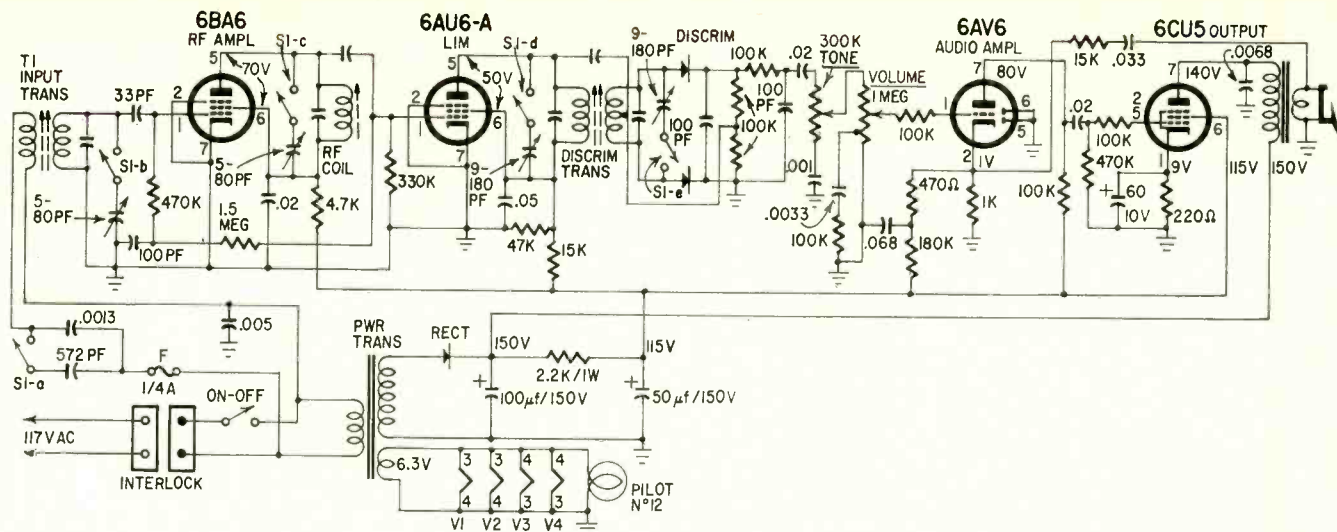
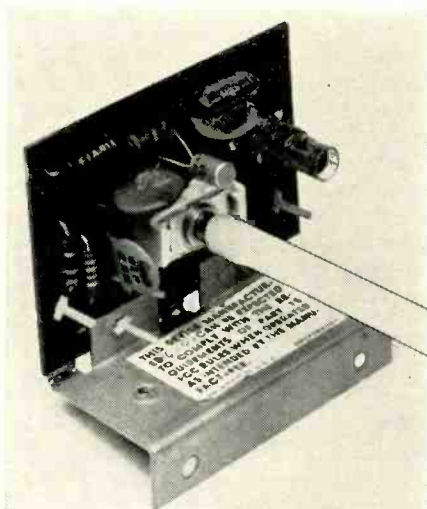

Fig. 2—Receiver circuit is much like i.f., detector and audio stages in small FM receivers. Tubes are V1, V2, V3, V4 from left to right.



(Westinghouse TV-Radio Div.)

Photo C. Small printed-circuit chassis is easily mounted on rear cover of TV receiver.

inputs from phonograph and radio. The signal is amplified and fed to the reactance tube (V2-a), which modulates the oscillator (V2-b) at an audio rate. The 6AU6-A rf output stage takes the modulated signal from V2-b's plate and feeds it into the power line through line-matching transformer T2. The transmitter operates on 300 kc with S1 open and 250 kc when it is closed.

The other half of V1 drives the NE-2L modulation indicator. It amplifies the audio signal from V1-a's plate. The ac voltage across the 56,000-ohm plate resistor causes the neon lamp to fire. The LEVEL control should be set so the lamp just flashes weakly on loud passages.

Fig. 2 is the circuit of the SP20A receiver. The FM signal is picked up from the power lines by T1 and amplified by V1. The limiter removes any residual AM and passes a clean FM signal to the discriminator. The de-

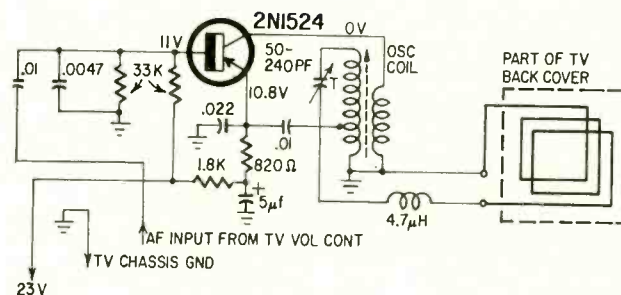

Fig. 3—This 1-transistor circuit is similar to that of a phono oscillator. It changes TV audio to broadcast band AM signals.

modulated audio signal is then amplified in the 6AV6-6CU5 amplifier.

The receiver is tuned to 300 kc when S1 is open. Closing it shunts a capacitor across each tuned circuit to tune it to 250 kc.

The HMDS service notes state that ac-dc radios with silicon rectifiers and light dimmers with silicon controlled rectifiers may create interference in the system. A .05- μ f 1,600-volt capacitor shunted across the rectifier will eliminate interference from ac-dc radios. Interference from other sources can usually be eliminated with an ac line filter placed close to the source. Check the ac line filter to see if there is a capacitor across the input side. If so, it must be smaller than .01 μ f. Otherwise, it will short out the signal.

Mobil Sound

This system consists of a Mobil Sound transmitter (Fig. 3) and the user's own AM radios throughout the house as needed. The transmitter is an AM oscillator that can be tuned to any clear frequency between 600 and 1000 kc in the broadcast band. Its small printed-circuit chassis and the radiating loop are mounted on the TV set's rear cover.

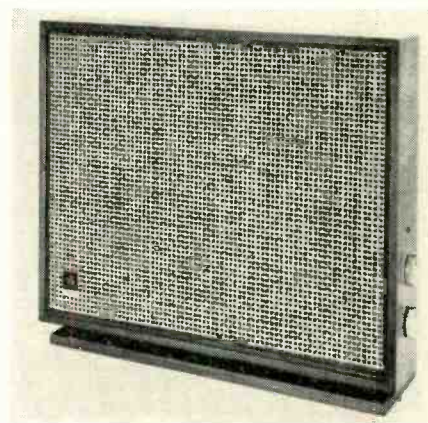

Front view of G-E's SP20 home-music receiver. On the right side are the pilot-light jewel, and the volume and tone controls.

The audio modulating signal for the Mobil Sound transmitter is taken from the high side of the TV set's volume control and fed to the transistor's base through the .01- μ f capacitor. The supply voltage (+23 volts) is tapped off the cathode biasing resistor of the set's audio output stage. The system is intended primarily for Westinghouse sets.

END

silent TV listening

Listen to TV without disturbing others or being tied to the set by headphone leads

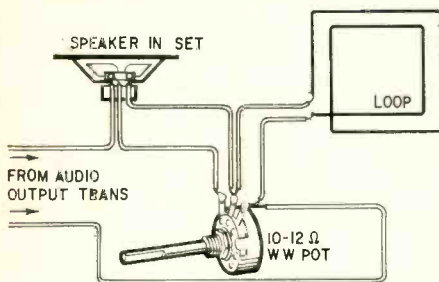
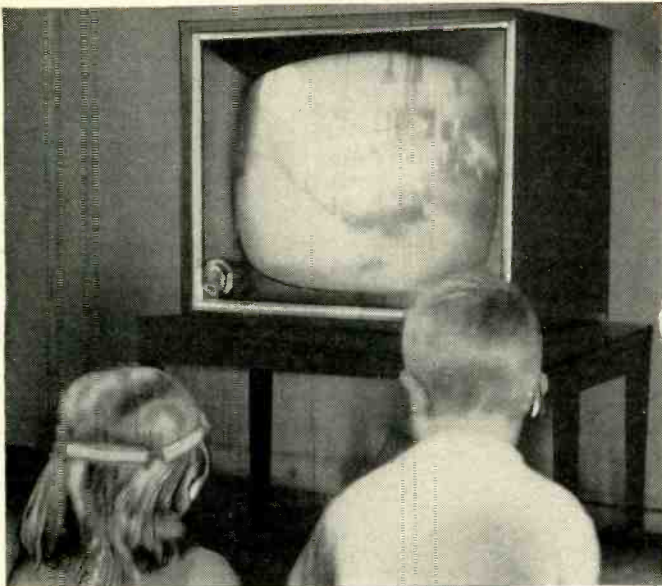

Fig. 1—Transmitter hookup at set.

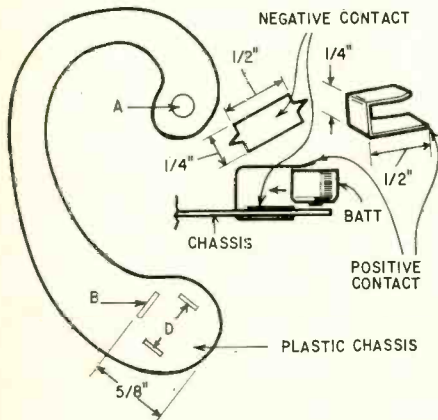
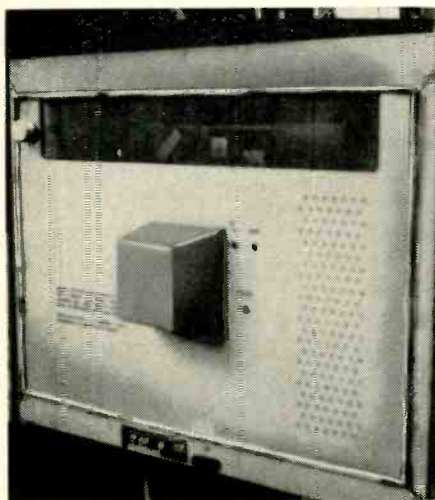

Fig. 2—Chassis and battery contacts for the receiver.



HAVE YOU EVER WANTED TO WATCH A late TV show, but had to call it off because other members of the family had retired? Does TV disturb those who wish to read or study? Is there someone in your home with a hearing defect who must turn up the volume, causing discomfort to others?

These are common problems in many homes but, if the TV sound could be confined to only those who wish to hear it, there would be no problem at all.

One easy solution is headphones. But this ties the listener to the set and leaves connecting wires all over the place.

The best solution is to use electromagnetic induction to "transmit" the audio portion of the program and little audio receivers and individual headsets to receive the sound. It's simple to set up—all you do is connect a loop of wire into the speaker circuit of your TV (it can also be used for radio and record players). This loop becomes a transmitting antenna that radiates the sound from your TV. Loop size depends upon the area you wish to cover, but make it as large as possible. It may be installed in the attic or on the basement ceiling. If this is not possible, mount it on the wall or under the rug. For a wall-mounted loop, I use 10 turns of ordinary hook-up wire around the limits of the wall. You can even wind a loop right on the back of the TV. For this you'll need at least 20 turns. But remember, the larger the loop, the greater the listening area and the louder the received sound. Also, a small loop requires more power than a large one for the same amount of coverage.

Fig. 1 shows how to connect the loop to the TV. Mount the potentiometer on the side of the cabinet or right on

You can wind the transmitting loop behind the TV.

the back panel. If you use the back panel, make sure the leads from the control are long enough to allow for removing the back for repairs.

You can use a switch in place of the pot if you wish. I prefer the pot as either sound or silent listening can be given preference in volume.

The receiver is a small transistor amplifier. It is very similar to a hearing aid, the only difference being the receiver has a pickup coil where a hearing aid would have a microphone.

It is possible to get somewhat limited reception without any amplifier at all with only an earphone. This can be further improved by connecting the earphone to a small loop 7 inches in diameter with 20 turns of No. 18 wire. We use this system when we haven't enough amplifiers to go around. To get away from the dangling cord and get more freedom of movement, the coil is worn like a halo.

Building the receiver

Designed to hang on the ear, the receiver is completely self-contained. Its chassis is a piece of soft pliable plastic. I cut mine from a squeeze bottle and suggest that you make a cardboard template to get the shape and size right before cutting the plastic. If you prefer a ready-made chassis with an earphone already attached, try the Lafayette AR-50 earphone. You may have to crowd the components a little, but they should all fit nicely.

The plastic chassis and battery contacts are shown in Fig. 2. Bend the lugs on the negative battery contact at right angles and insert them in slits D in the base. Then bend them over to hold the contact in place. Insert the lower end of the positive contact through slit B in the base.

Pass the lip of the earphone, to which the eartip mold is attached, through hole A in the plastic base, then

The whole receiver fits behind your ear.

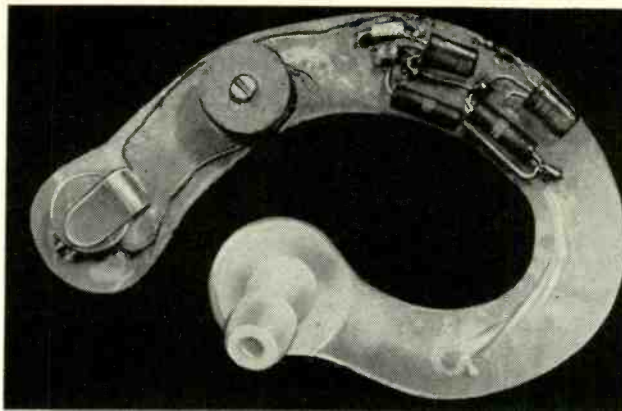

- R1—22,000 ohms, 1/4 watt
- R2—1,000 ohms, 1/4 watt
- C—Miniature electrolytic, 1 to 6 μf (not critical) 3 volts
- L—pickup coil (see text)
- V1, V2—CK784 or other pnp audio transistor
- 1.4-volt mercury battery (Mallory RM675, RM630 or equivalent)
- High-impedance earpiece (Lafayette AR-50 or MS-260)

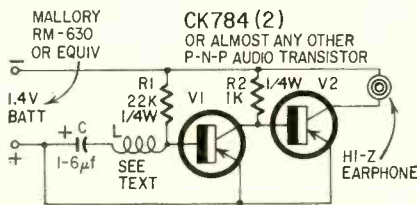
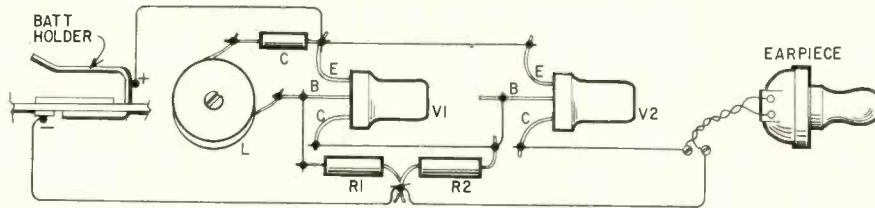

Fig. 3—Circuit (left) and component arrangement (above) for the receiver.

large hole A to pass the mold.

The receiver circuit is in Fig. 3. Those who prefer a ready-made amplifier should try Lafayette's PK-522. Simply use a pickup coil rather than a mike at the amplifier input. This amplifier is a bit bulky and will not fit behind your ear. Carry it in your shirt pocket and run a connecting cable to the earpiece.

snap the eartip mold back in place. If the plastic chassis is too thick for the mold to snap onto the earphone, en-

The pickup coil I used is a spool type coil 1/4 inch deep, 1/2 inch in diameter, and wound full of No. 40 enameled wire on the spool winder of a sewing machine.

Another possible pickup coil is a small high-impedance iron-core unit. Its length should be greater than its diameter. I've used one other coil successfully. It was wound around four 3/16 x 1/4-inch strips of transformer lamination. Use No. 40 enameled wire and wind enough for about 500 ohms dc resistance.

Coupling capacitor C is a subminiature electrolytic—any value between 1 and 6 μf will work. Almost any p-n-p small-signal audio transistors can be used for V1 and V2. The earphone is a high-impedance magnetic unit. The two-transistor receiver draws 1.5 ma. Removing the battery turns it off.

Cement all components to the plastic chassis with clear nail polish. Solder all leads to anchor points made by looping short lengths of wire over the component leads and through small holes in the chassis. Once the unit is completed and you are sure it works, coat the whole assembly with a liberal layer of clear nail polish, but be sure you don't get any on the battery terminals.

Of the many advantages of silent listening, the important one is you have one ear free for other sounds around the house which you otherwise would not hear. END

Three puzzlers for the student, theoretician and practical man. They may look simple, but double-check your answers before you say you've solved them. If you've got an interesting or unusual answer send it to us. We are especially interested in service stinkers or engineering stumblers on actual electronic equipment. We are getting so many letters we can't answer individual ones, but we'll print the more interesting solutions (the ones the original authors never thought of). We will pay \$10 and up for each one accepted. Write EQ Editor, Radio-Electronics, 154 West 14th St., New York, N.Y.

Answers for this month's puzzlers are on page 76.

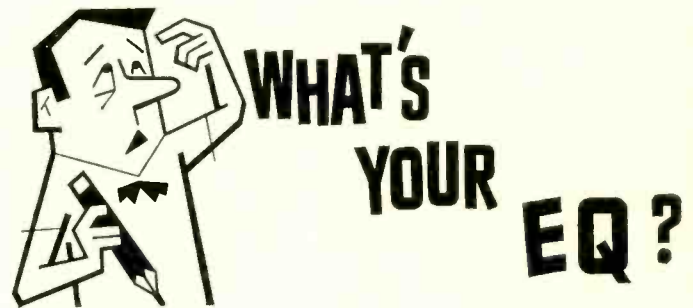

Voltmeter Puzzle

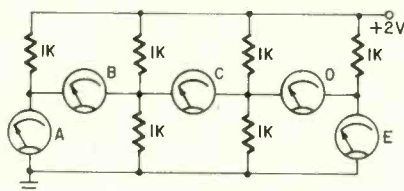

Voltmeters B, C and D show zero volts. What is the voltage reading on voltmeter A and voltmeter E?—Kendall Collins

How Many Diodes?

What is the lowest number of diodes required to obtain full-wave rectification?—Richard L. Koelker

Doubling in Capacitors

The circuit below is a full-wave

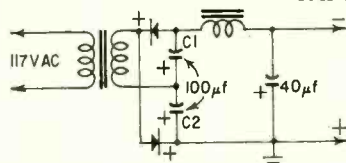

doubler bias supply for a push-pull class-AB1 amplifier. If capacitor C1 were to open, what would happen?—Edward R. Beach.

That Four-Bulb Puzzler

A number of our readers have called our attention to the fact that 6-volt (or fractionally higher rating) Zener diodes would give better results in the circuit (March, page 59) than

thermistors, since they would not use any power until the bulb failed, and that, when it failed, the voltage drop across the Zener diode would be a closer approximation to that of the bulb than would be the case with a thermistor.

Correction

A number of readers caught the error in the answer to the question "How Much Voltage" in this column of the April issue. The error was in equation 4. It should have read

$$2/3(0.3E_{in}) + 0.1E_{in} = 10$$

$$0.2E_{in} + 0.1E_{in} = 10$$

$$0.3E_{in} = 10$$

$$E_{in} = 33.33 \text{ volts}$$

Our thanks to all the readers who spotted the error. END

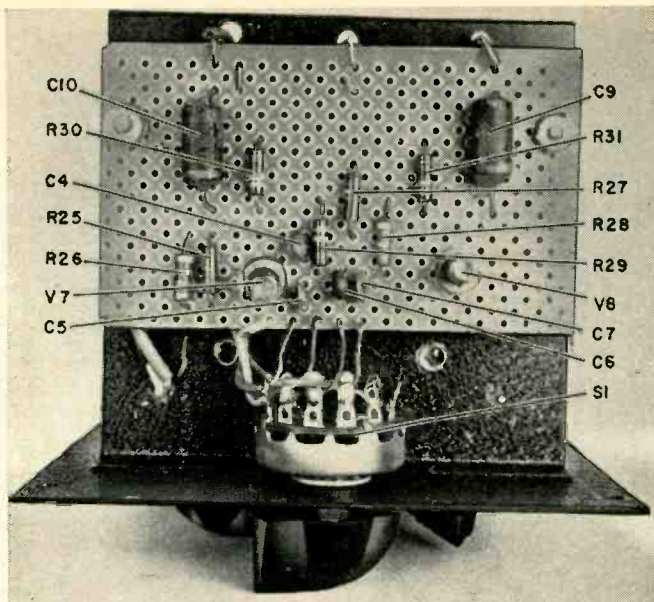

Closeup (above) of multivibrator board. Top board (right) holds major portion of circuitry.

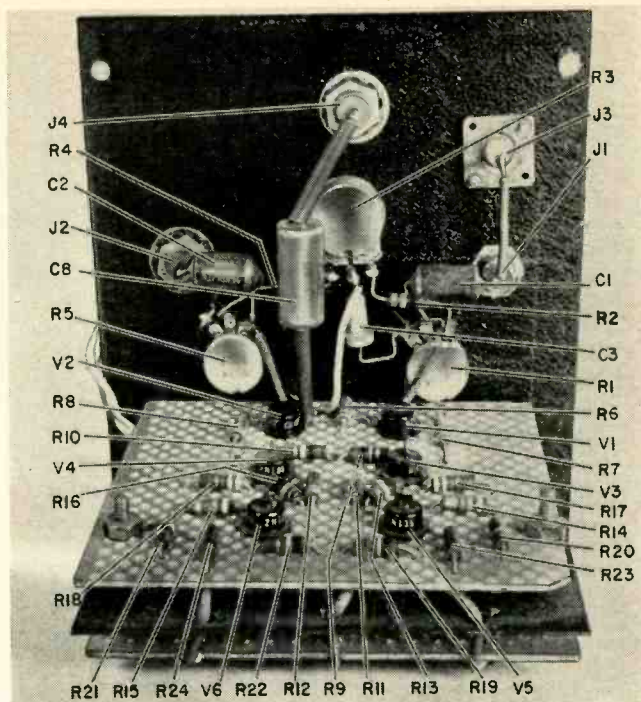

By DAVE STONE

TRANS-SWITCH— electronic scope switch

8-transistor unit is a cinch to build

The Trans-Switch is an all-transistor scope attachment that lets you display two different waveforms simultaneously on your scope screen. You can, for instance, compare an audio amplifier's input and output signals so any distortion or phase shift can readily be noted. Or you can compare input and output waveforms of a square-wave converter, pulse amplifier, delay circuit or the like. Generally, any two signals in the audio range that are related to each other can be fed into this switching unit for comparison or matching.

Eight transistors are used in the Trans-Switch (see schematic). All are inexpensive. The other components are standard miniature types, and overall cost of construction is nominal. Layout and construction are not critical—you can build this unit in almost any manner you desire. All components shown in the photos are miniature types but can be replaced with standard-size equivalents if compactness is not important.

How it works

The heart of the circuit is the switching amplifiers V1 and V2. First, V1 conducts. Its input signal is amplified

and fed to the scope, while V2 is cut off. At the end of the period determined by SWITCHING FREQUENCY control S1, V1 is driven into cutoff and V2 conducts to pass its input signal to the scope. This switching action is too rapid for the eye to follow and results in two simultaneous traces on the scope screen.

The switching frequency is generated by V7 and V8 arranged in a multivibrator circuit. S1 selects different timing capacitors to change the R-C time constant and produces switching frequencies of approximately 1, 2.5, 4 and 15 kc. The output pulse at V7's collector is 180° out of phase with the output pulse obtained from V8's collector. At any one instant V5's base is driven with a negative pulse from V7, and V6 receives a positive pulse from V8. During the next instant the pulse polarities reverse to place a positive signal at V5's base, and a negative pulse at the base of V6.

Transistor pairs V3 and V5 and V4 and V6 are squaring circuits that convert the multivibrator's pulses to fast-rising square waves to drive the emitters of V1 and V2. When a negative pulse is fed to V5's base, it produces a positive

square wave at V3's output which drives V1 into conduction. At the same time, the positive pulse at V6's base produces a negative square wave at V4's output which drives V2 into cutoff. Then the switching action reverses itself. Any signals fed into the base circuits of V1 and V2 are sent on to the scope as the transistors alternately conduct and produce two distinct signal waveforms on the scope screen.

The CHECK position on S1 is for checking the condition of the battery. It allows power to be applied to the unit, but disables the multivibrator by removing the timing capacitor, and allows only a single trace to appear on the scope screen. If the battery is in good condition, any signals at the input jacks will be amplified and appear on the single trace. Power requirements are only 3 to 4 ma at 6 volts, so the battery will last a long time.

POSITIONING potentiometer R3 moves the two traces closer or farther apart, or it can be used to put one trace on top of the other. The input signal level to each amplifier stage is controlled by CHANNEL GAIN potentiometers R1 and R5.

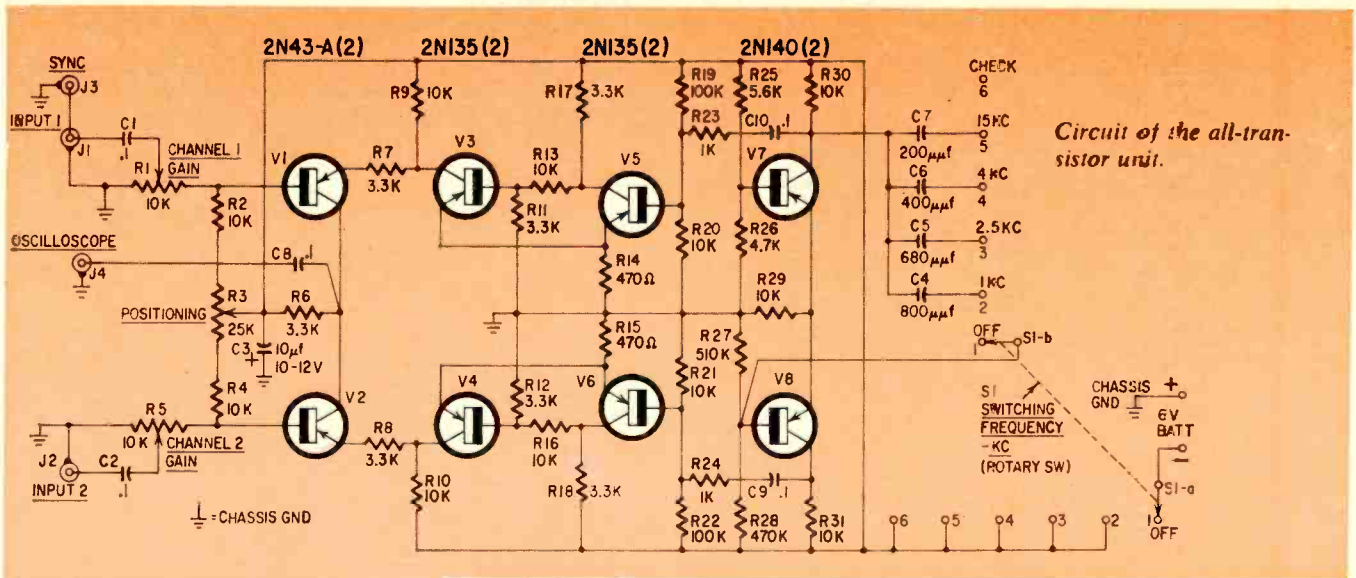

Circuit of the all-transistor unit.

- R1, R5—miniature pots, 10,000 ohms
- R2, R4, R9, R10, R13, R16, R20, R21, R29, R30, R31—10,000 ohms
- R3—miniature pot, 25,000 ohms
- R6, R7, R8, R11, R12, R17, R18—3,300 ohms
- R14, R15—470 ohms
- R19, R22—100,000 ohms
- R23, R24—1,000 ohms
- R25—5,600 ohms
- R26—4,700 ohms
- R27—510,000 ohms, 5%
- R28—470,000 ohms
- All resistors 1/2-watt, 10% unless noted
- C1, C2, C8, C9, C10—0.1 μf, 200 volts paper
- C3—10 μf, 10 or 12 volts, miniature electrolytic or tantalum
- C4—800 μmf, mica or ceramic
- C5—680 μmf, mica or ceramic
- C6—400 μmf, mica or ceramic
- C7—200 μmf, mica or ceramic
- BATT—6 volts (author used 7.5-volt bias battery tapped at -6 volts)
- J1, J2, J3, J4—coaxial or audio jacks
- S1—6-position 2-pole rotary
- V1, V2—2N43-A
- V3, V4, V5, V6—2N135
- V7, V8—2N140
- Chassis and case to suit (see text for size of unit author used)
- Miscellaneous hardware

Construction

A 4 x 5 x 6-inch steel cabinet with an attached shelf was on hand, and all the circuitry, with the exception of the jacks and potentiometers, was mounted on two perforated boards and attached above and below the shelf. The pots, input and output jacks and switch S1 are mounted on the front panel. Although layout and lead dress are not critical, the use of small low-voltage components and close placement of transistors will result in short lead lengths.

The upper board contains the circuitry for transistors V1 through V6. V1 and V2 are mounted at the front of the board close to the input controls. V5 and V6 are mounted at the back of the board. The flexible leads of these transistors are wired directly into the circuit.

The lower perforated board contains the multivibrator transistors V7 and V8, whose short rigid pins require sockets. Timing capacitors C4 through C7 are small ceramic or mica units mounted close to S1 to provide direct wiring. Leads from coupling capacitors C9 and C10 go through the shelf to connect to the circuitry on the upper board.

A C-bias battery was selected for the convenient mounting feature of its

flat shape, and is fastened with brackets to the top of the enclosure.

The constructor can vary the layout by mounting all the components on a single board, or larger components can be substituted. Coaxial type jacks were used for their small size, but any good quality jack can be used. Be sure to grip the flexible leads of the transistors with long-nose pliers to dissipate excess heat while soldering.

Checkout and use

After the unit is assembled, insert a milliammeter in series with the negative battery lead. Turn S1 to the 1 KC position and note whether the current drain is in the normal range of 3 to 4 ma. If it is appreciably higher, switch to POWER OFF immediately and recheck the wiring, and transistors if necessary, to determine the defect.

If the drain is normal, leave S1 in the 1 KC position and connect a lead from the OSCILLOSCOPE jack to the scope's dc input jack. The dc input connection is recommended since most inexpensive scopes have better square-wave response without the coupling capacitor used in the ac position. Set the scope's sync selector to internal and note a square wave appearing on the screen. If it is not perfectly symmetrical, or has some spikes riding on it, don't be too concerned; they do not affect the operation of the switching unit.

Connect a lead from the switcher's SYNC jack to the scope's external sync jack and rotate its sync-selector switch to the external position. Two distinct traces will appear on the screen, and rotating R3 will move them closer or farther apart. Note the appearance of the two traces at all settings of S1, except in the CHECK position. Return S1 to the 1 KC position, connect the audio generator, set at 10 kc, to the CHANNEL 1 input jack. Rotate the gain control for this channel to its full open position and adjust the generator output for a sine

wave on one of the two traces. Run a parallel lead from the audio generator to the CHANNEL 2 input jack, and adjust its gain control for a sine wave on the other trace. Then adjust the POSITIONING control to superimpose both waveforms to obtain a single trace. If the waveforms mesh perfectly, it indicates that both amplifier stages are identical as far as phase shift is concerned.

Become thoroughly familiar with the action of all controls and experiment with the sweep frequency ranges on the scope, as well as the amplitude controls of both Trans-Switch and scope. The selection of the switcher's best switching frequency setting depends upon the frequency of the signal fed into it. As a rule of thumb, use the 1-kc setting for input signals between 10 and 25 kc, the 2.5-kc position for signals between 1.0 and 10 kc, the 4-kc setting for signals in the 100 to 1,000-cycle range, and the 15-kc setting for frequencies below 100 cycles. In any case, adjust S1 for the smoothest waveform traces possible. At all positions, the switching action may show up as a light

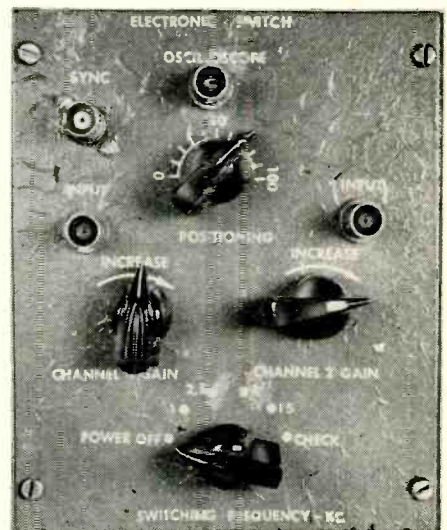

Front-panel view of the instrument.

background haze if the scope's intensity control is turned up, but it hardly shows at the usual intensity level.

Once you are thoroughly familiar with the controls, put the unit to practical use. An amplifier can be tested by injecting a signal from an audio generator into the amplifier's input and the CHANNEL 1 input at the same time. The amplifier's output can be terminated in its usual resistive load, and the output signal picked off to feed the CHANNEL 2 input.

Connections between Trans-Switch and scope are the same as those for the checkout; J4 to the scope's vertical amplifier dc input, J3 to the scope's external sync jack, the scope set to external sync. Adjust the channel gain controls, positioning, scope gain control, S1 and the scope's sweep frequency switch for equal-amplitude signals on both traces. The signals can now be compared for any possible distortion, or superimposed for phase-shift comparison. Adjustments to the amplifier can now be made and the results, relative to the input signal, can be readily observed on the scope.

In all applications, bear in mind the Trans-Switch input impedance is dependent upon the setting of the gain controls, so a high-impedance connection to the input jack may have to be isolated with a pad or small capacitor to avoid loading the equipment being checked. As a general tool and useful oscilloscope attachment, the Trans-Switch is hard to beat for all audio work. END

After the Computer, What?

(Continued from page 23)

still take a year to produce an intellectron.

In addition, after completion, the intellectron must still *continue to learn* new facts from time to time—just as humans must—if it is not to fall behind in its general knowledge.

Yet with all these "human" accomplishments, the intellectron will still be a machine.

Then what good are these intellectual machines? They will be able to do thousands of tasks and replace humans who will rarely compete with them. You could give verbal orders to them and count on getting back correct evaluated answers from their encyclopedic memories, either *verbally* or typed out neatly in a variety of languages.

They will become invaluable in commerce, business, science, literature, and in all the arts. They will be robots, but *intellectual* robots.* —H.G.

* See also "Billions of Electronic Facts," December 1959 RADIO-ELECTRONICS; "Brain An Electric Computer," March 1960 RADIO-ELECTRONICS, and "Are Thinking Computers Possible?," August 1962 RADIO-ELECTRONICS.



which dry battery for you?

There is a best dry battery for every job.

This article will help you pick it out.

by GORDON E. KAYE*

DRY BATTERIES ARE MADE IN THREE common types, commonly called zinc-carbon, alkaline and mercury. The zinc-carbon battery is further divided into four varieties. These were described in the article "What Is A Dry Battery?" in the May, 1963, issue. Each of these types has its own best applications, due to its composition or the proportions of the elements used in its mix. The table illustrates some typical consumer applications and the reasons for choosing correct battery types for them. There are hundreds of other industrial, military and commercial devices using dry batteries.

A rather special application is that of voltage standard. The industrial-grade mercury battery may be used as a voltage-reference source. (Some varieties of mercury cells made with a manganese dioxide blend are not suitable as

a voltage reference. The MnO_2 causes a reading of 1.4 volts. This can be spotted easily.) At intermittent drains up to 1 ma, it is within 1% of its original 1.357 volts for a period of 2 to 10 years. Aged cells, after 3 years, can have a long-term stability of 0.1%.

Direct measurements may be made on these cells with ordinary voltmeters. Voltage potentiometers are not needed, except where more precise readings are required and calibration against a primary standard is called for. You can attain short-term accuracies in the order of one part in a million, especially if the temperature is a stable 120°F, and the cell has been aged. The average open-circuit voltage of these cells doesn't seem to drift over the years, as shown in Fig. 1.

Selecting a battery type

The simplest economic viewpoint

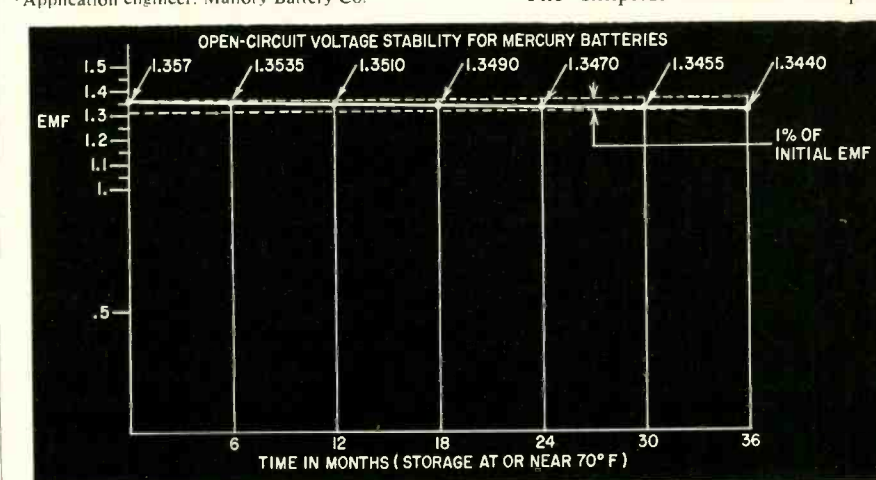

Fig. 1—Chart shows excellent shelf-life of mercury cells and batteries.

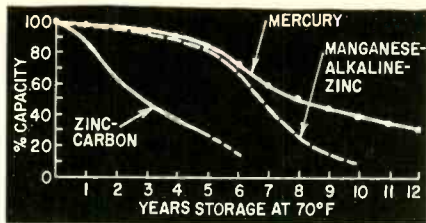

Fig. 2—Expected shelf-life of the three battery systems at 70° F. Storage at 120° F reduces shelf-life to one-fourth the values shown.

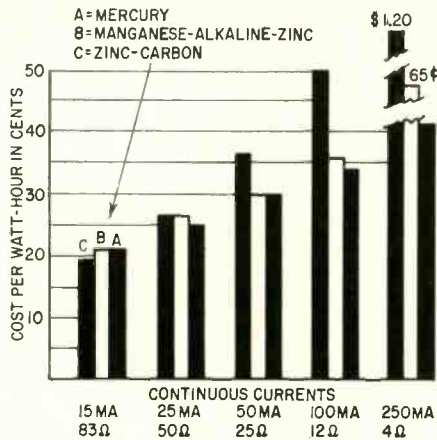

Fig. 3—Comparative costs per watt-hour of the three battery systems at different load levels.

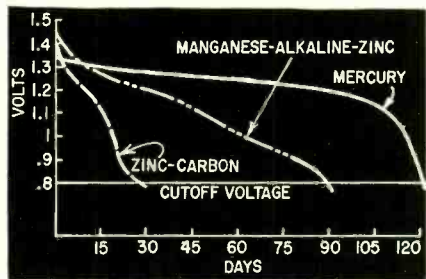

Fig. 4—Life-span of cells discharged into 60-ohm loads for 8 hours per day at 70° F.

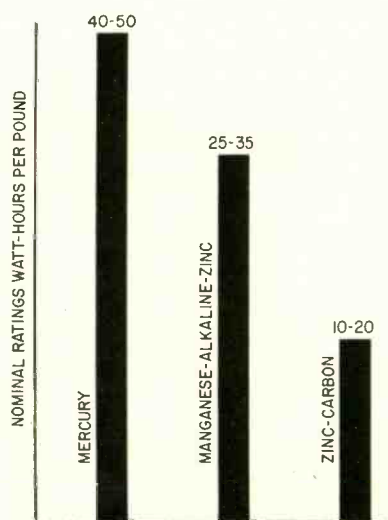

Fig. 5—Comparative watt-hour per pound ratings of the three primary cell systems.

BATTERY APPLICATIONS TABLE		
APPLICATION	BATTERY TYPE	REASONS FOR CHOICE
Portable transistor radios	Mercury	Constant output. Longest service. Less replacement but higher initial cost. Highly leak-resistant.
	Manganese-alkaline-zinc	Fairly constant output. Long service. Highly leak-resistant.
	Zinc-carbon	Reasonable service. Lower initial cost. Somewhat leak-resistant.
Photography Photo flash (external) Battery movie camera Miniature strobe lights Built-in flash Battery-operated light meters	Manganese-alkaline-zinc	Low impedance.
	Mercury, manganese-alkaline-zinc	Maximum energy per unit volume.
	Manganese-alkaline-zinc	Low impedance for rapid recycling.
	Manganese-alkaline-zinc	Highest reliability with low impedance.
	Mercury	Accurate, stable reference voltage.
Flashlights	Zinc-carbon	Good for intermittent service. Lowest cost.
	Manganese-alkaline-zinc	Long shelf life between uses. Highly leak-resistant.
Toys (battery-operated)	Zinc-carbon Manganese-alkaline-zinc	Low cost. Better performance.
Tape recorders	Mercury Manganese-alkaline-zinc	Maximum energy per unit volume. Flatter voltage curves provide good speed regulation.
Electronic instruments	Mercury	Highly accurate voltage. Long shelf life. Highly leak-resistant. Maximum power for miniature equipment.
	Manganese-alkaline-zinc	Good for intermittent loads in vom circuits.
Clocks and watches	Mercury	Long service and shelf life.
	Manganese-alkaline-zinc	Highly leak-resistant.
Hearing aids	Mercury	Maximum power available for miniature systems.

in dry-battery use is the cost of delivered energy per hour (cost per watt-hour). Not so obvious is the inclusion of a shelf-life factor (Fig. 2) as well as a quality-rating factor. The latter would be important in high-quality appliances such as battery-operated tape recorders, cameras, wristwatches or light meters. If equipment is left unused for a long time, leakage and loss of capacity can raise battery operating costs. Equipment damage and undelivered energy are valid charges against a cell system.

The chart in Fig. 3 compares the cost per watt-hour for the AA penlight cell in the three dry-cell types. Various current rates are shown against costs, based on list prices for top-grade cells. It can be seen that heavy loads raise energy costs appreciably. There is an economical cell size for each application. Also, the alkaline systems are less costly in heavy-duty, long continuous service, especially where voltage levels are to remain high (Fig. 4). Shelf life and leakage factors also tend to favor these systems.

Zinc-carbon cells and batteries are more economical initially, and are favorable in lightly loaded, intermittent applications. They are less costly in the larger cell sizes due to a higher efficiency when operating at nominal rates.

Watt-hour ratings per pound (Fig. 5) are decisive in many applications where weight and bulk must be kept to a

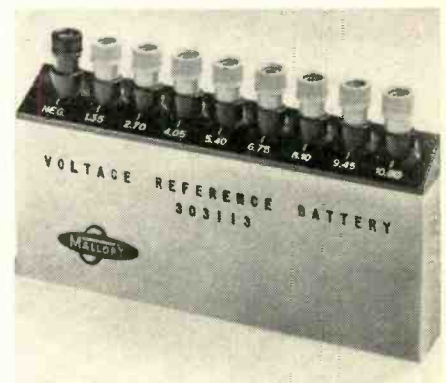

A 10.8-volt voltage-reference battery.

minimum. The dry-battery products manufactured today represent the accumulation of 70 years of industrial electrochemical experience, beginning with Leclanché and continuing right through to the advanced-design mercury cell. The number of batteries required per product is reduced, battery efficiencies are higher, and their operating costs are consequently lowered. An example of this is seen in the compact, modern transistor radio.

Selecting the right battery, however, requires that you consider battery capabilities in terms of application requirements. Regardless of the application, there is a correct cell or battery design for maximum performance. The table and charts will, we hope, assist you in your selection.

END

what's DIFFERENT about Industrial Electronics

A lot less than you think

By DELLROYE D. DARLING*

MANY RADIO AND TV SERVICE TECHNICIANS have considered going into industrial servicing, but most of us are a little frightened of what might be expected of an industrial technician. We had the same problem when television first became popular. Wise radio technicians familiarized themselves with the new art, and were ready when the time came. But just what are the differences and similarities between the TV-radio service field and the industrial electronic technician's job?

Basic principles

A good knowledge of the basic principles of electricity and electronics is necessary to *GOOD* servicing in either field. There are no "new" principles in industrial electronics, but the old ones are applied in new or different ways. The industrial man will probably need an even better basic knowledge than the radio-TV man. There are important similarities between different makes and models of TV sets. An experienced man uses this as a time-saver. Many routine repair jobs are done more by experience than by troubleshooting (example: bad filters, selenium rectifiers).

The industrial technician usually has to work with a wide variety of equipment, intended to perform many jobs. Although he may become familiar with much of the equipment in "his"

*Director, industrial electronics, Radio Electronic Television Schools, Detroit 26, Mich.



Simpson Watt-voltmeter is typical of specialized instruments used in industrial electronics repair work.

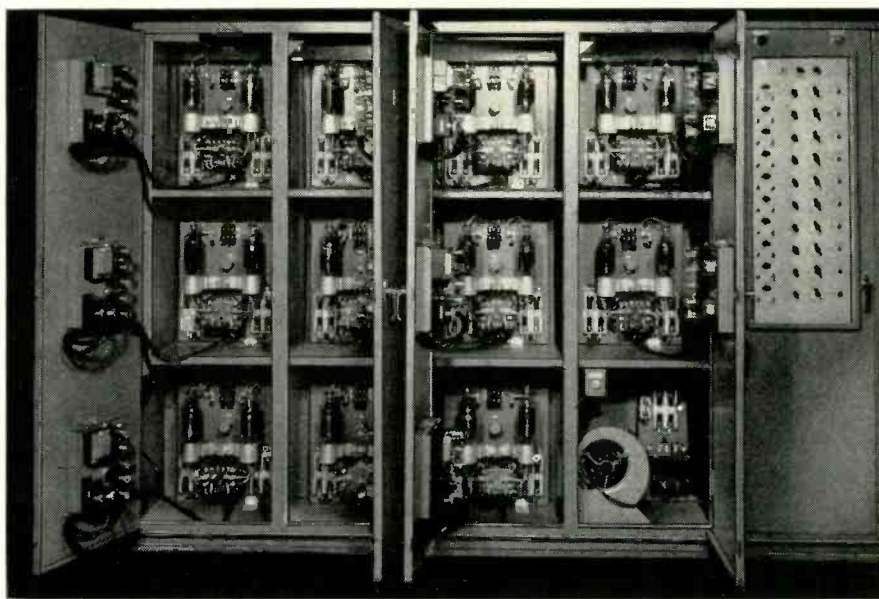

Robotron Corp.

Although this industrial phase-shift power control panel contains 77 thyratrons, it is actually a simple 7-tube circuit, repeated 11 times.

plant, new controls are continually being added. Many will have to be thought out and their principles of operation studied before an intelligent troubleshooting procedure can be arrived at. A basic knowledge of electronics, circuit tracing, etc., is essential here.

The industrial technician will be called on to *recommend* equipment for specific jobs. He may also have to adapt existing controls to new applications. This borders on engineering, and will give him plenty of opportunities to test his knowledge and ability.

Complex circuits

The first comment of many radio-TV technicians when they see a large industrial control is "Boy! What a mess of stuff! How do you know where to begin?" The panel they're looking at probably contains fewer tubes and parts than a TV receiver; it's just larger.

Few industrial control circuits are as complex as a TV set. Many are much simpler than an ac-dc radio. Although the capacitors, resistors and transformers may be large, they operate just like the ones in smaller equipment. The laws of reactance, resistance and impedance work the same here as they always did. A word of caution, though. If we make

a mistake in replacing a resistor in a TV set, the cost of another resistor may be only 15¢. A similar mistake in repairing a motor control might ruin equipment worth many dollars.

Another point works in favor of the industrial technician. Most manufacturers include with their service information and diagrams (which invariably accompany a new piece of equipment) a complete description of its operation. Industrial circuits usually lend themselves to step-by-step explanations of how they work.

Test equipment

Most of the test equipment used by the industrial technician is familiar to the radio-TV technician. Multimeters, scopes, tube testers, etc. are essentially the same in both fields. Industrial equipment may be more ruggedly built, because of the conditions under which it is used. Some of the instruments, such as ammeters, ac voltmeters, etc., are highly specialized, and may have only one range. But their operation should be no mystery to a TV technician.

One or two "new" instruments are worth mentioning, for example the recording oscillograph. It is simply a meter designed to record its readings on



Industrial technician makes resistance checks in "brain" panel of Robotron weld timer.

moving chart paper. The movement of the meter hand (which carries a pen) is similar to the vertical sweep on a scope, while the movement of the paper chart is equivalent to the horizontal sweep. This instrument is used for recording various waveforms and electrical quantities, such as the voltage applied to resistance welders, over a period of time.

Another is the industrial or lab type scope, which often has dc coupling, driven sweep and other features not usually found in TV service instruments.

Gas-filled tubes

Gas-filled tubes such as thyratrons and ignitrons differ greatly from vacuum tubes familiar to the TV man. It is common knowledge that a gas tube, once allowed to conduct or "fire," will not stop conducting until the anode (plate) supply is cut off. For this reason, most industrial circuits using these tubes operate on ac, rather than a dc B-supply, as in a TV set.

This use of an ac supply leads to complications, such as phase relationship between tubes with their anodes returning to opposite sides of the line, etc. The industrial technician must have a good working knowledge of ac theory if he is to understand these circuits.

Large tubes, such as ignitrons, may handle thousands of watts of power. They produce a lot of heat and must be water-cooled. The cooling equipment is also under the care of the industrial technician. So it helps to be part plumber, or at least to be able to tell him where you think the trouble is.

Mechanical knowledge

Most industrial controls operate with or are part of machinery of some kind. The operation of the control may be so bound up with that of the machine that it is difficult to tell whether a given trouble is mechanical or electronic. Mechanical skill is a big help in these cases.

Most TV technicians are pretty good at fixing remote tuner drives, record changers and similar mechanisms.

This ability will go a long way to help them understand production machinery. The industrial man has the opportunity (and the need) to learn a lot about machinery in the course of his work. For example, if you are going to repair a spotwelder control panel, you must know a little about resistance welding.

Voltages and currents

TV technicians are accustomed to working with high voltages. However, familiarity breeds contempt. Most ignore the fact that accidental contact with the secondary of a power transformer can mean death. Most are used to getting minor shocks.

A nonchalant attitude toward electricity can be fatal for an industrial man. Although most of the equipment he works on may have no higher than 460 volts, these voltages come directly from the line, and there is plenty of power available. There is an old proverb: "It's the current that kills you." This is definitely true. The high voltage supply in a TV set may not be able to deliver enough current, even at 18,000 volts, to cause more than an unpleasant "bite". A few hundred volts from a heavy power line can give an unwary technician his last thrill.

A very important part of the industrial technician's tool kit is a padlock. It is used to lock disconnect switches off while repairs are being made. Don't trust others to remember that you are inside the cage working. Someone who doesn't know the situation may turn the power back on, causing a serious accident.

But don't let this frighten you. In spite of all the opportunities for a service technician to electrocute himself, he is still safer at work than he is driving home afterward. Simple, commonsense caution is all that is needed.

Working conditions

Like the TV technician, the industrial man works part of the time relaxed, and part of the time under pressure. "Must be done by Saturday" jobs

are common in any TV shop. The industrial man gets a different kind of pressure. Most industrial electronic controls are vital to production. Failure for even one hour can mean hundreds or thousands of dollars lost.

For the first half hour, the foreman keeps the technician company. Then the superintendent steps in to do some over-the-shoulder looking. The pressure gets worse. If the equipment is "down" long enough, the boss may even come in from the golf course, and then the perspiration flows freely. But it's all part of the job. Keep quiet and keep working.

Something can be done to help prevent these unpleasant situations. A good system of preventive maintenance allows most routine work to be done when the equipment is not in use, and will prevent many production breakdowns.

The industrial technician has compensations for this extra pressure. For one thing, he doesn't have to argue irate customers into paying him for his work. His employers usually have a pretty good idea of the difficulties under which he works. He has better working hours, usually getting off at a time that allows him the evening with his family. He has fringe benefits, too: opportunity to take advantage of training programs, a steady wage, and a number of other things that most TV technicians do without.

To sum it up, industrial electronic repair is interesting, rewarding work. It pays good wages, offers a challenge to the mind and opportunities for advancement. Radio and TV repair can offer these things, too. Which field suits a man better depends mainly on the man himself. END

Bell-Button Battery Holder

A door-bell pushbutton added to the back of a dual battery holder is an ideal switch for many experiments. Originally it was made to provide power

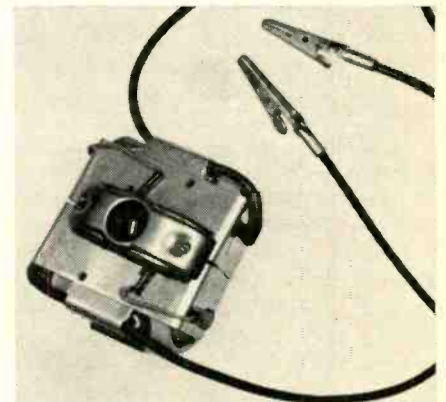

for one of the many electric experimenter kits. It has since found many other uses in testing model-motor coils, relays and other devices where it is necessary to apply power intermittently.—E. C. Carlson

Lafayette
HE-55

Seco
530



NEW ACCESSORIES IMPROVE CITIZEN'S BAND OPERATION

Added amplifier overcomes transmission-line losses and effectively places transceiver at antenna base. Ant and squelch circuits quiet receiver circuit when channel is not in use

By **ROBERT F. SCOTT**
TECHNICAL EDITOR



The Black Box CB antenna amplifier.

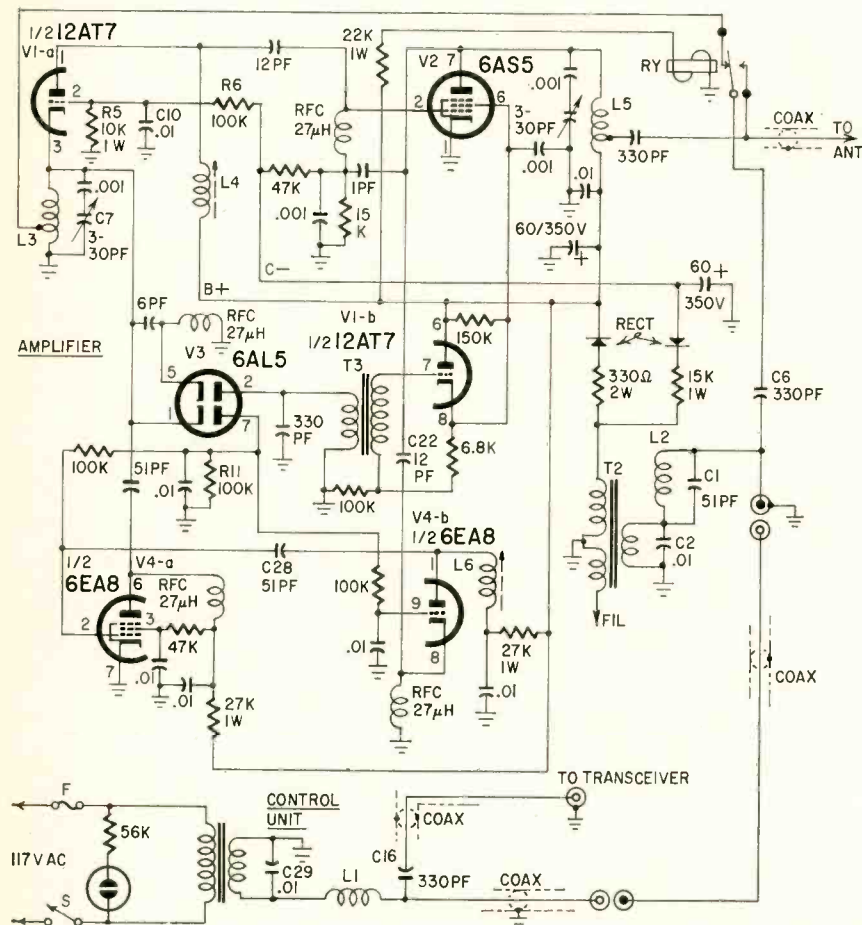

Fig. 1—Circuit of the ME-82 antenna amplifier.

A number of new accessories can be used to improve the efficiency and operation of a CB station. Two of these—a remote antenna amplifier and a combination automatic noise limiter and squelch are especially valuable to the CB'er who wants more from his equipment.

The Black Box model M-82 Citizens-band antenna amplifier is a unique accessory made by the Antenna Specialists Co. of Cleveland, Ohio. It is a four-tube unit that operates as a receiving preselector and booster with a minimum gain of 20 db, and as a modulated rf amplifier with a power input of 4.9 watts when transmitting.

The Black Box consists of a control unit (30-volt ac power supply and rf decoupling network) and the antenna amplifier. The control box (3 x 4 x 5 inches) is inserted in the lead-in close to the transceiver and is plugged into the ac power line. The amplifier is mounted on the mast within 10 feet of the antenna. The transmission line (RG-58/U) carries the rf signal to and from the antenna and also carries the operating voltage up to the amplifier.

The circuit is shown in Fig. 1. The modulated rf signal from the transmitter appears across the tuned circuit in the cathode return of V1-a, a grounded-

grid amplifier. The grid is biased by a negative voltage at the junction of R5 and R6. C10 grounds the grid for rf.

A part of the incoming rf signal is rectified in half of V3, and the extracted audio is fed through transformer T3 to the grid of audio amplifier V1-b. The rf voltage at V1-a's plate drives V2, the modulated rf amplifier. V2 is screen-grid-modulated by V1-b operating as a cathode follower. The amplified and re-modulated rf signal is tapped off tank coil L5 and fed to the antenna through a short length of transmission line.

During reception the incoming signal appears across tank coil L5 and is fed through C22 to the cathode of V4-b operating as a grounded-grid amplifier. The amplified signal across L6 is then fed to the grid of amplifier V4-a through C28. The signal is then fed from the plate of V4-a through tuned circuit L3-C7 to the transmission line going to the transceiver.

The second half of V3 serves as a T-R switch. In transmission, this section of the tube develops a high negative voltage across R11. This biases both sections of V4 to cutoff.

The relay is used to return the circuit to straight-through operation, by-passing the amplifier, when the Black Box system is not being used. It also returns the system to normal operation if power fails in the amplifier.

The power supply in the amplifier consists of transformer T2 with a 30-volt primary and 6.3-volt and high-voltage secondaries. L2, C1 and C2 provide rf isolation, and C6 blocks dc.

The control unit is simply a 30-volt ac power supply shunting the transmission line between the transceiver and antenna-mounted amplifier. Network L1-C29 prevents rf voltages on the line from being shunted to ground or attenuated by the power transformer. C16 is a dc blocking capacitor that prevents dc from being fed into the transceiver's rf circuits.

When receiving, the M-82 boosts the signal at the antenna at least 20 db. This more than compensates for losses in the transmission line and brings the signal up to a level where it overrides noise generated on the transmission line and in the transceiver's front end. When transmitting, the booster compensates for losses in the transmission line and effectively places your transceiver within 10 feet of the antenna.

Anl and squelch

The Lafayette HE-55 Squelcher and Seco 530 Signal Filter are two electrically identical receiving accessories that can be used with almost any tube type superhet receiver with a reasonable amount of i.f. gain. They are a combination of a carrier-controlled

squelch and one of the most efficient automatic noise limiters in use today. They quiet the receiver under no-signal conditions and reduce static and ignition noise to a barely discernible level.

Although the units can be used in

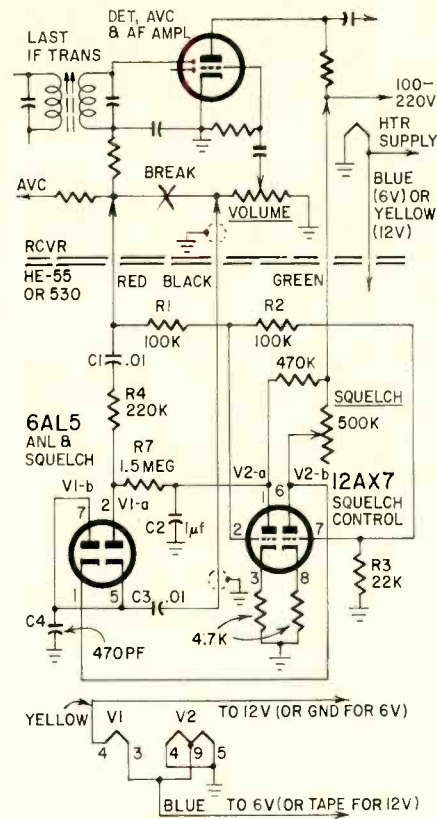

Fig. 2—Circuit of the Lafayette HE-55 and Seco 530 anl and squelch. They can be used with superhet type CB units that do not include these features.

base stations, their greatest value is in mobile installations that are constantly plagued by ignition noise and interference from power lines, electrical signs and other devices. They are installed by breaking one lead in the receiver's detector circuit and connecting five leads. Hams and SWL's will recognize the circuit as the TNS (Twin Noise Squelcher) developed around 10 years ago.

Fig. 2 shows the HE-55 or 530 connected to the detector and first audio circuits of a typical superhet. R1, R2 and R3 are now a part of the detector load. Audio and a dc voltage proportional to signal strength are developed across these resistors. The circuit is arranged so the audio from the detector passes through C1, R4, V1-a and C3 to the volume control. V1 is a series type automatic noise limiter and V2 is the squelch and anl control tube. It controls the conduction through V1 by varying the relative voltages on the plate of V1-a and cathode of V1-b.

The SQUELCH control is normally adjusted so V1-a's plate is slightly more

positive than V1-b's cathode when a signal is coming in. The diodes conduct and the signal passes through to the volume control.

Static or ignition noise with a fast rise time develops a negative pulse across R3 that drives V2-b toward cutoff so its plate and V1-b's cathode rise in proportion to the noise amplitude. V1-a's cathode is positive with respect to its plate for the duration of the noise pulse so the diodes cut off, chop a hole in the audio and prevent the noise from reaching the speaker.

Simultaneously, the negative-going pulse from the detector is fed to V1-a's plate through C1 and R4. This increases the effective positive voltage on V1-b's plate and provides faster and more positive noise elimination.

The audio fed to V2-a's grid is amplified and then filtered by C2-R7 so the dc voltage on V1-a's plate follows the modulation envelope and varies with average signal strength. Thus, the average voltage on V1-a's plate is optimum for efficient noise squelching, regardless of the percentage of modulation of the incoming signal.

When no signal is coming in, there is little or no dc voltage (negative) across the detector load. Now, V1-b's cathode is positive with respect to V1-a's plate so the diodes are cut off and the receiver is silent. The SQUELCH control is usually set so the background noise is barely discernible when no signal is coming in. As soon as a carrier comes on the air the squelch opens and the audio modulation is heard. END

New Solid Capacitor Contains No Electrolyte

A tantalum capacitor, only .065 inch in diameter and less than 0.2 inch long, with a capacitance of .01 μf and a working voltage of 125, has been announced by General Instrument Corp. The new capacitor, called *Hi-VolTan*, has no electrolyte. It consists of a needle-thin tantalum wire, electrochemically coated with an ultra-thin film of tantalum pentoxide, which is the dielectric. A metallic outer connection to this dielectric completes the capacitor. Compared with solid electrolytic tantalum devices, *Hi-VolTan* withstood higher voltages, is much smaller, has a higher Q and higher dielectric resistance (more than 150,000 megohms at 100 volts) and greater stability with variations in temperature, frequency and voltage. The capacitor is being put out initially in four series, up to .003 μf at 125 working volts and at 100 working volts; from .003 to .005 at 50, and from .005 to .01 at 25 working volts.

Electronics Teaching Aids

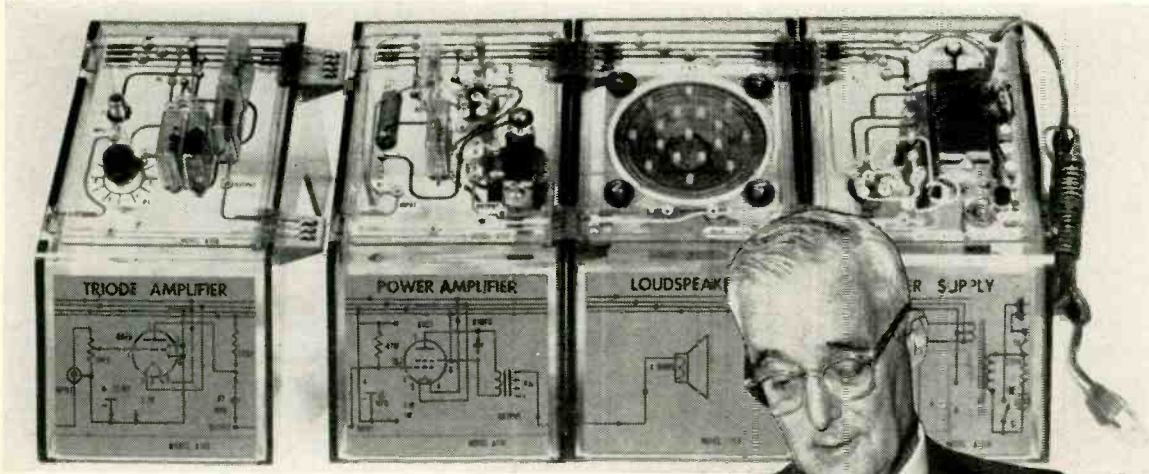

Wide World Photo

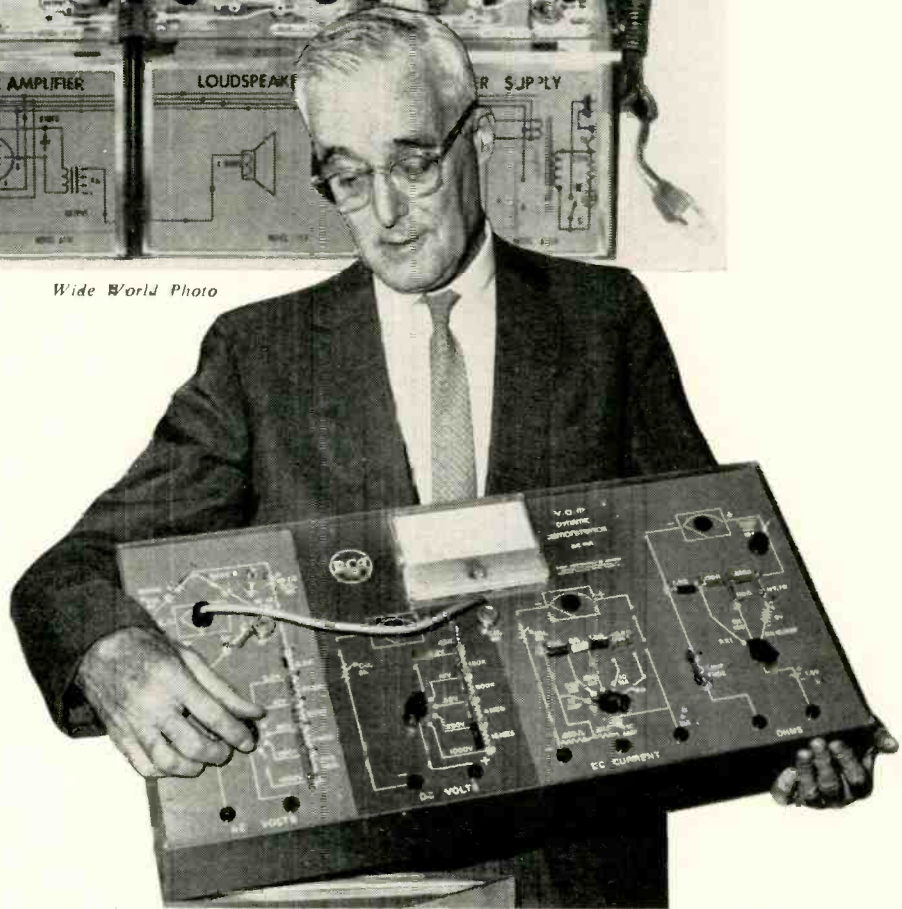

THE PHOTOS SHOW THREE NEW DEVICES intended to aid in teaching electronics. One, being held by John R. Meagher, is an RCA "Dynamic Demonstrator". A large-scale volt-ohm-milliammeter, it will be offered in kit form for use in classroom demonstrations and instruction. The kit can be assembled easily by students to demonstrate its functions and operations, and its practical use as a test instrument.

The second device is actually a series of building blocks—electronic blocks that fit together to form such circuits as phono amplifiers, power supplies and many others. They come with a text and represent a complete course in basic electronics. Electronic Aids Inc., Baltimore, Md. makes this teaching aid. Circuit leads are color coded to simplify circuit explanations. A teacher can tell quickly how far a student has advanced simply by the number of the block he has just finished studying.

Third and last shows what may be the largest transistor radio ever made. It is EICO's transistor radio demonstrator kit. When completed it measures $40\frac{3}{4} \times 27\frac{3}{4} \times 3\frac{1}{2}$ inches. It is designed to be assembled in class by the teacher or students. By learning while building, the class sees how the circuitry is assembled, how the transistors work, where they go in a radio and what each component does. Since the parts may be slipped in and out, the demonstrator can be used to show what happens when various components in the set break down.

Eico also makes a companion transistor portable in kit form. As the teacher assembles the demonstrator, students can work along with him on their own regular-size models.

END

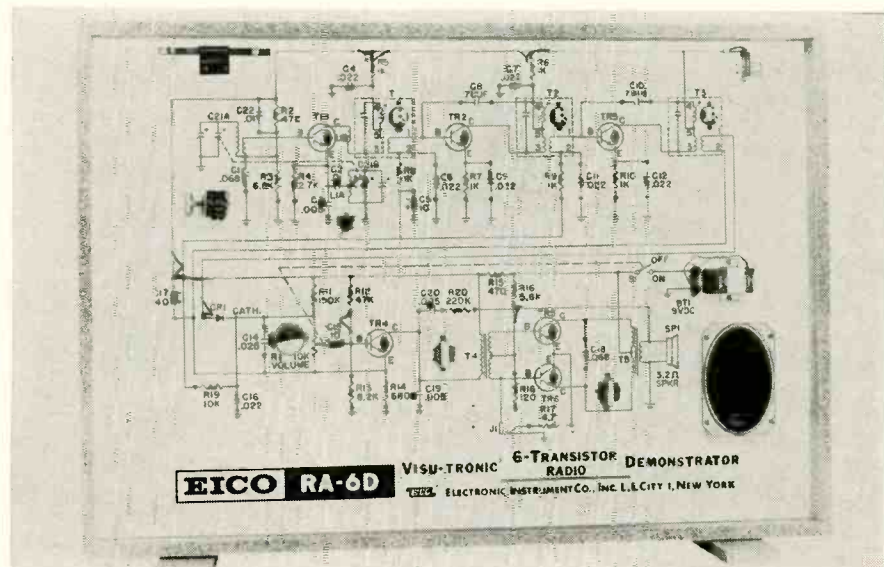

WILL YOU GENTLEMEN PARDON ME IF I get away from the customary technical content of this column and take a short ride on my favorite hobby horse? In fact, I'd like to have you join me. At the very beginning, I'd like to state that this is going to be a definite case of "Don't do as I *do*: do as I *say*!" For I have made some very embarrassing departures from the principles I am going to advocate here!

To me, the major difficulty in our profession has always been *diagnosis*. You'll agree that the typical TV repair job is 95% diagnosis and 5% execution. The total amount of work you do on any job depends on the accuracy of your diagnosis.

Here's another controversial statement: It does not depend so much upon the *accuracy* of your measurement equipment as upon the *interpretation* of its readings! The most valuable piece of test equipment in any shop is that mass of blue mud between your ears! So, from the depths of over 30 years of experience, and a vast amount of practice in making stupid mistakes, let me hold forth on some of the basic principles I discovered during that time.

There is a key word in this connection: logic! We *must* be able to think *logically*: to observe conditions found in the circuit and draw from them a set of logical conclusions. We must avoid, at all costs, the too-common practice of making snap judgments. Over-quick decisions lead to a sort of mental short circuit and inhibit our thinking processes.

We must be able to fulfill the three conditions for scientific analysis of a problem: "open eyes, open ears, *open mind*!"

I know it's hard to keep yourself from getting in a diagnostic rut. The trained TV technician, seeing a set not operating properly, automatically starts running over in his mind all of the things that could cause such troubles. Like an IBM card sorter, our minds run rapidly through the lists, and come up with a set of cards that could contain the answers. However, as in detective stories, all we have now is a set of possibilities, *not* a definite answer!

In this, as in any similar profession, a negative answer is as valuable as a positive one. If we find out that a suspected part is *not* causing our trouble, we have valuable information: we've reduced the number of suspects by one. If we replace a certain tube and the trouble is still there, we know that it wasn't the cause, even though it *was* in the last case with similar symptoms. We check that off and go on through our list of suspects, knowing that we have reduced it by that much.

About the most common complaint in TV work is "I've tried every-

SERVICE CLINIC

Conducted by JACK DARR
SERVICE EDITOR

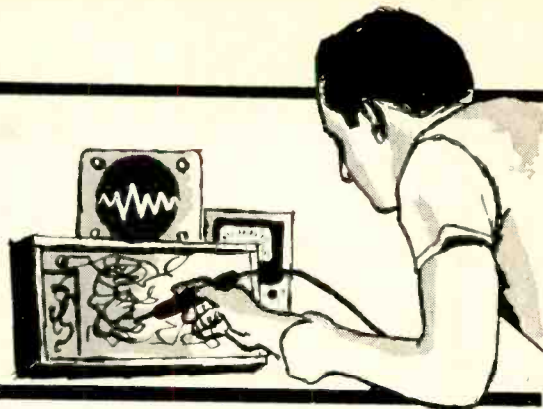

This column is for your service problems—TV, radio, audio or general and industrial electronics. We answer all questions individually by mail, free of charge, and the more interesting ones will be printed here.
If you're really stuck, write us. We'll do our best to help you. Don't forget to enclose a stamped, self-addressed envelope. Write: Service Editor, Radio-Electronics, 154 West 14th Street, New York 11, N.Y.

thing in that circuit and it still doesn't work!" This kind of set can provide some of our most annoying problems. However, it usually indicates a mental block or preconceived idea in the diagnosis. If we can back away and look at the problem *logically*, we will see that one fact is very prominent. For example, we have a set with "horizontal oscillator output trouble." No high voltage, sweep, etc. So, we replace all the parts, and still no hv, no sweep, etc.

What is the key fact that we are unable to see, in cases like this? A logical analysis of the trouble and of the tests made up to this point, parts replaced, etc., will point to only *one* thing, if we can get rid of our fixed notions: The trouble is *not in that stage!* All tests made so far have given negative results; that is, they have failed to restore the set to operation. Therefore, the trouble *must* be elsewhere! (We will omit the case, where, hours or days later, one of the "good" replacement parts turns out to have been bad.)

Very red-faced, I must admit that the "Yuletide effect" puzzler on page 43 of the August 1961 issue is a perfect example. Human nature being what it is, I hate to admit it, but this one stuck me for something like 10 days! Not for lack of thinking about the trouble, not for lack of adequate test equipment, but simply because I *knew* the trouble *had to be* in the horizontal oscillator output stages.

Always be willing to admit that there is a distinct possibility that your original diagnosis was completely wrong, or wrong because of insufficient experimental evidence, and you're well on the way to becoming a master diagnostician in this field!

There is one thing I'd like to add in closing. We really ought to change the quotation in the beginning to read like this, for "commercial use": "Open eyes, open ears, open mind, mouth *tightly shut!*" This is especially impor-

tant when customers insist on an immediate diagnosis in the home. Keep your oral orifice firmly closed until sufficient evidence has been accumulated to prove the validity of initial guess. (For that's what it is—a guess, until you've had a chance to make some actual tests!) It is also very wise to leave yourself a loophole, even then. Say "It seems to be the ——. Let me check it and find out." Best method: confine yourself to noncommittal grunts and "hmm's". Did you ever watch an old doctor examining a patient? If you ask him what the trouble is, he never says quickly, "It's gallstones, appendicitis, etc." He just looks wise, says, "Hmm!" and keeps his mouth shut until he *knows!* We'd all be a lot better off if we did likewise!

Picture size vs raster size

Why is the picture on a TV screen smaller than the raster? I've noticed this on several makes; not at top or bottom, just on the sides.—W. T., Benson, Sask., Canada.

The actual picture on a TV screen is always smaller than the raster by the amount of horizontal blanking. Fig. 1
(Continued on page 58)

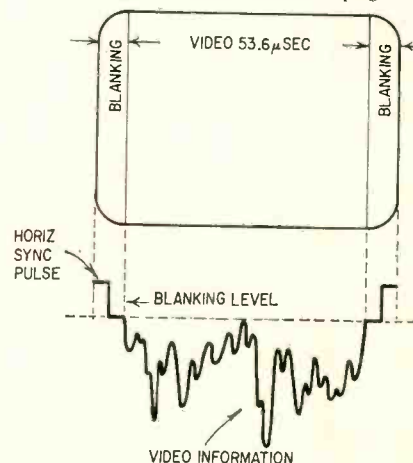

Fig. 1—Picture tube is cut off during blanking time, making picture smaller than raster.

RCA introduces a new easy way to learn electronics at home

**Learn faster, remember more with this revolutionary new "learning method".
And RCA Institutes, Inc. is first to bring it to you!**

Forget all your old ideas about learning! If you have a natural inclination or ability in the exciting field of electronics, that's all you need to prepare yourself to join the thousands of other successful electronic students who are building profitable careers right now! RCA's new learning method, RCA "Autotext" helps you do the rest! This new easy way to learn electronics uses the latest scientific development in the field of home training! You learn more quickly, and with less effort!

How does RCA "Autotext" work? "Autotext" is a system of programmed instruction, scientifically planned so that as you read a series of statements, questions, and answers, you automatically learn almost without realizing it. Each step of this new method is carefully coordinated with illustrations, complete kits, and service practice lessons. It's fun to learn this new RCA way!

We'll prove it to you! Interested in Electronics? No previous knowledge or experience? RCA "Autotext" is your answer! Right now RCA Institutes offers you a complete Home Training Course using the "Autotext" method called "Introduction to Electronics". And you get a complete set of theory lessons, service practice lessons, and all the kits you need. Most important of all, it takes almost all of the effort out of learning the groundwork of the electronics field.

FREE OFFER! We'll send you complete information on amazing new RCA "Autotext" along with a FREE SAMPLE of a lesson to prove to you how easy it is to learn this new way. Send the attached postage-paid card and check "Autotext".

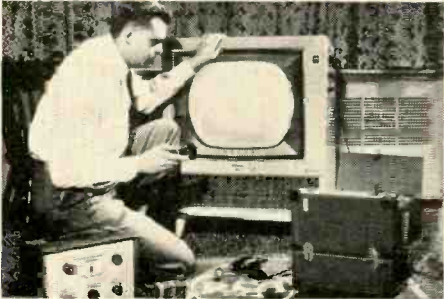
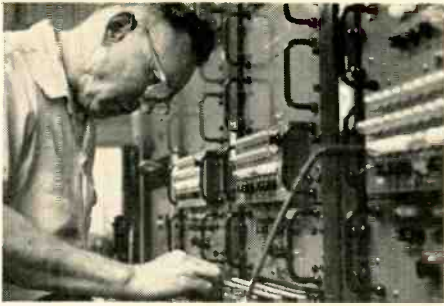

Wide choice of Home Training courses in Electronics:

In addition to the new **Introduction to Electronics**, RCA Institutes offers this complete selection of Home Training Courses:

- Electronic Fundamentals
- TV Servicing
- Color TV
- Communications Electronics
- FCC License Preparation
- Mobile Communications
- Automation Electronics
- Computer Programming
- Transistors
- Electronic Drafting
- Electronic Fundamentals (in Spanish)

All RCA Institutes Home Training Courses are complete step by step easy-to-understand units. You get prime quality equipment in the kits furnished to you, and all of it is top grade. It's yours to keep and use on the job, and you never have to take apart one piece to build another.

Liberal Tuition Plan. RCA Institutes Home Study Courses, including the new "Introduction to Electronics" Course, are available under a liberal tuition plan. This plan affords you the most economical possible method of home study training. You pay for lessons only as you order them. If, for any reason, you should wish to interrupt your training, you can do so and you will not owe a cent until you resume the course. No long-term obligations!

Personalized Instruction. With RCA Institutes Home Training, you set your own pace in keeping with your own ability, finances and time. RCA Institutes recognizes the fact that no two students are alike in learning ability. RCA Institutes Home Training helps students to learn at their own speed in the most effective manner. Your lesson assignments are individually graded by technically trained personnel, and helpful comments are added where required. You get theory, experiment, and service practice beginning with the very first lesson. All lessons are profusely illustrated—a complete training package in every way.

CLASSROOM TRAINING

RCA Institutes Resident Schools in New York City, Los Angeles and RCA Technical Institute in Cherry Hill near Camden, N. J., offer classroom training that will prepare you to work in rewarding research and production positions in many fields of electronics. No previous technical training required for admission. You are eligible even if you haven't completed high school.

Free Placement Service. RCA Institutes Resident School graduates are now employed in important jobs at military installations, with important companies such as IBM, Bell Telephone Labs, General Electric, RCA, in radio and TV stations and in communications systems all over the country. Many other graduates have opened their own businesses. A recent New York Resident School class had 92% of the graduates who used the FREE Placement Service accepted by leading electronics companies, and had their jobs waiting for them on the day they graduated!

Coeducational Day and Evening Courses are available at Resident Schools. You can prepare for a career in electronics while continuing your normal, full-time or part-time employment. Regular classes start four times a year.

SEND POSTCARD FOR FREE ILLUSTRATED BOOK TODAY! SPECIFY "AUTOTEXT", HOME STUDY OR CLASSROOM TRAINING.

RCA INSTITUTES, INC. Dept. RE-63

A Service of Radio Corporation of America,
350 West 4th St., New York 14, N. Y.,
Pacific Electric Bldg., 610 S. Main St., Los Angeles 14, Calif.



The Most Trusted Name in Electronics



The New Concept in Receiving Tube Reliability and Performance!



The quality of Mullard electron tubes can be attributed to their design and manufacture . . . for built into each tube, at the very outset, are basic components and features which will insure long life and performance . . . engineering achievements such as coiled heaters, unique grid designs and special cathode materials. Each tube reflects advanced techniques in glass-to-metal sealing, evacuation control and precise electrode spacing.

But today, quality cannot be measured by performance or long life alone. New exacting circuits require a new concept of receiving tube reliability, for they demand more from a tube. The 10M tube has been engineered to satisfy this new concept.

Each 10M tube is subjected, *individually*, to a comprehensive laboratory test procedure based on *extremely tight and stringent parameters* for contact potential, cathode stability, grid cut-off, grid emission, heater current, transconductance, interelectrode leakage . . . to insure tube-to-tube uniformity . . . to insure that all electrical specifications are met . . . to insure section-to-section uniformity . . . to insure that each tube will operate in a circuit *exactly* as it was designed to perform and at levels kept within the closest possible tolerances. Each 10M tube is *guaranteed* to provide this exact performance . . . is *guaranteed* for 10,000 hours within a two-year period . . . is *guaranteed* for uniformity.

The 10M tube *IS* the new concept of receiving tube reliability and performance.

IEC International Electronics Corporation

81 Spring St., New York 12, N. Y.

6272 W. North Ave., Chicago, Ill. • 4260 Lankershin Blvd., N. Hollywood, Calif.

10M tubes are available today to satisfy your tube requirements . . . and are now in stock at your local 10M distributor. For further information and name of your local 10M distributor contact your nearest IEC office.

International Electronics Corporation
Please send 10M tube literature & distributors list

Name _____

Address _____

City _____ Zone _____

State _____

(Continued from page 53)

shows this. Notice, in the waveform for one single scanning line below, that the signal cuts off the picture tube during horizontal blanking time. This is to keep the sync from showing in the picture, also to kill retrace lines.

Total time for one line, blanking and all, is 63.6 μ sec. Blanking time is 10 μ sec, leaving 53.6 μ sec for video information. So we set up a TV raster to show only the video information. The blanking period is always off-screen, with approximately half at each side.

Arcing in crt

We have a Sparton 23V5 in the shop, with a 21ATP4 in it. The complaint is a snapping noise, caused by arcing in the CRT; it blows the hv fuses. Seems to be between grids 2 and 4. The focus control was open, and we had a zero reading on grid 4. Since it was replaced, we read 600 volts there. The arcing continues, however. Do you think this could be a defective CRT?—W. R. S., Annapolis, Md.

This is always a possibility. There is one trick which I have used in similar cases: place the set so that the picture tube is face down. Apply voltage between the elements, and

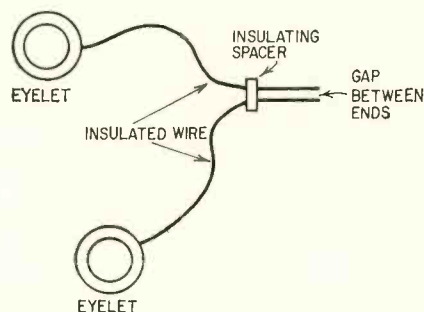

Fig. 2—Spark gap used by Zenith to prevent internal CRT arcing. Eyelets are slipped over CRT base pins between any two elements that might arc over.

tap the neck gently. Actually, your arcing couldn't be between the grids themselves because of the spacing, but between one of the grids and an adjacent side rod in the gun structure. There is a distinct possibility that a tiny flake of conductive material is lodged somewhere, reducing the spacing.

You might try reducing the voltage applied to G4; many of these tubes focus with much less than 600 volts. In fact, they are often grounded. Zenith has a clever way of eliminating this (not the arcing, but the danger of damaging other parts). They use a tiny spark gap installed on the base of the CRT (Fig. 2). The gap between the ends of the wires is much less than a gap inside the gun, so if there is any flash-over, it takes place harmlessly outside of the gun.

I believe I would check this CRT very carefully, while the tube is hot, for shorts or leakage. Incidentally, if you happen to have one of the "CRT harnesses" used with Hickok and similar tube testers for checking CRT's, try hooking this up and running a short check. This uses a fairly high voltage, and I've accidentally burned off several shorts with it!

24AJP4 replacement

What picture tube will replace a type 24AJP4?—L. D., Martin, S. D.

A 24AEP4 should be a good replacement. A 24ASP4, 24ANP4 and a few others are good prospects. There is only one thing to watch out for in making a replacement like this

(aside from electrical characteristics, of course). This is faceplate curvature. For example, a 21YP4 is electrically identical with a 21FP4, but the -FP4 has a cylindrical faceplate, while the -YP4 has a spherical faceplate. Consequently, it won't fit the mask used with the -FP4.

Hammond organ

A Hammond organ has a very noisy pedal-volume control. When the slider is pulled out, it makes a loud buzz and popping noise. I can't get into the thing; I'm afraid of tearing it up!— P. Q., Waldo, Ark.

This is actually a variable capacitor. Two brass cups are slid into and out

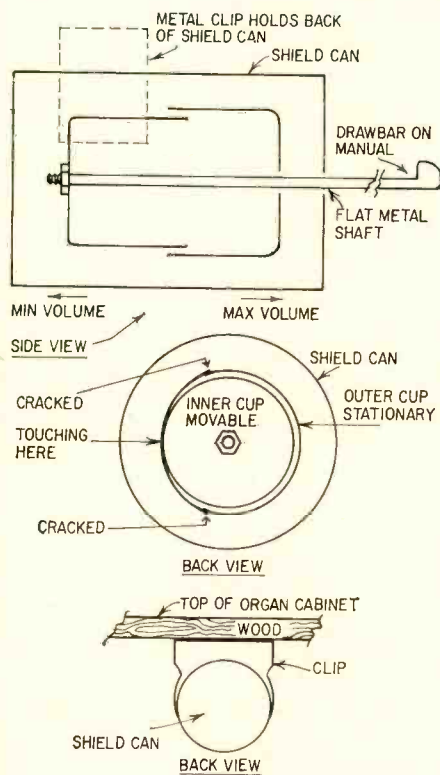

Fig. 3—"Piston" type variable capacitor used as pedal-volume control on Hammond organs. Touching cups cause noise.

of each other by the metal shaft you see on the front panel over the manuals (Fig. 3).

If these cups touch each other, you will get a very loud noise and a buzz. In several cases, the outer cup has cracked and warped, allowing the inner (movable) cup to touch it.

To cure this, take the shield off. This is a round aluminum can fastened to the underside of the top of the organ cabinet by friction fit. Very carefully pull the can back and down, out of the clip, exposing the two cups. You'll be able to see where they are touching.

Bend the outer can back to round, and move the control several times, to be sure it isn't touching. No voltage; you can check it with the organ on. END

JUNE, 1963

CHECKS AND REJUVENATES ALL PICTURE TUBES WITHOUT ADAPTORS OR ACCIDENTAL TUBE DAMAGE



the all NEW

Featuring Automatic Controlled Rejuvenation

SENCORE

CR125 CATHODE RAY TUBE TESTER

From SENCORE, designers of the famous Mighty Mite Tube Tester and other valuable time savers, comes another industry best. An all new method of testing and rejuvenating picture tubes. Although the method is new, the tests performed are standard, correlating directly with set-up information from the RCA and GE manuals.

Check these outstanding features and you will see why this money making instrument belongs on top of your purchasing list for both monochrome and color TV testing.

Checks all picture tubes thoroughly and carefully; checks for inter-element shorts, cathode emission, control grid cut-off capabilities, gas, and life test.

Automatic controlled rejuvenation. A Sencore first, preventing the operator from over-rejuvenating or damaging a tube. An RC timing circuit controls the rejuvenation time thus applying just the right amount of voltage for a regulated interval. With the flick of a switch, the RC timer converts to a capacity type welder for welding open cathodes. New rejuvenation or welding voltage can be re-applied only when the rejuvenate button is released and depressed again.

Uses DC on all tests. Unlike other CRT testers that use straight AC, the CR125 uses well filtered DC on all tests. This enables Sencore to use standard recommended checks and to provide a more accurate check on control grid capabilities. This is very important in color.

No interpretation chart. Two "easy view" neon lights clearly indicate shorts between any element. A chart is included for interpretation of shorts, if desirable. This chart is not necessary for normal testing on the CR125.

No adaptor sockets. One neat test cable with all six sockets for testing any CRT. No messy adaptors, reference charts or up-dating is required. The Sencore CR125 is the only tester with both color sockets. (Some have no color sockets, others have only the older type color socket.)

No draggy leads. A neat, oversized compartment, in the lower portion of the CR125 allows you to neatly "tuck away" the cable and line cord after each check in the home.



All six sockets, including latest color socket, on one neat cable.

SENCORE, INC.

426 S. WESTGATE DRIVE
ADDISON, ILLINOIS

SPECIAL INTRODUCTORY OFFER WORTH \$5.00

Most SENCORE products are sold by recommendation. So that you will be first in your area to buy and recommend the CR125, this coupon is worth \$5.00 on the purchase of the CR125 when presented to your parts distributor.

Why not save \$5.00 now?

Herb Bowden
President

Only Sylvania receiving tubes



LIFE-BOOST* CATHODE...a big bonus in tube quality

Sylvania's exclusive LIFE-BOOST Cathode is putting new life into tubes—and sales. This latest evidence of Sylvania leadership in tube technology offers benefits you can really sell: it virtually eliminates performance slump, a major cause of profit-stealing callbacks. Besides stability, it produces significantly better tube life and uniformity. 90 types already have LIFE-BOOST, with more on the way...and it's being heavily promoted in national magazines and by mail. *Trademark

New edition of Sylvania Technical Manual. Valuable 632-page dealer reference lists data on over 2,000 tube types, is fully indexed and tabbed for quick reference. Free supplementary data service to keep your manual current. Price \$3.00 through your Sylvania Distributor.



give you these 2 big bonuses:

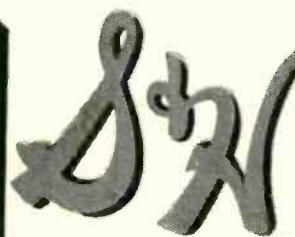
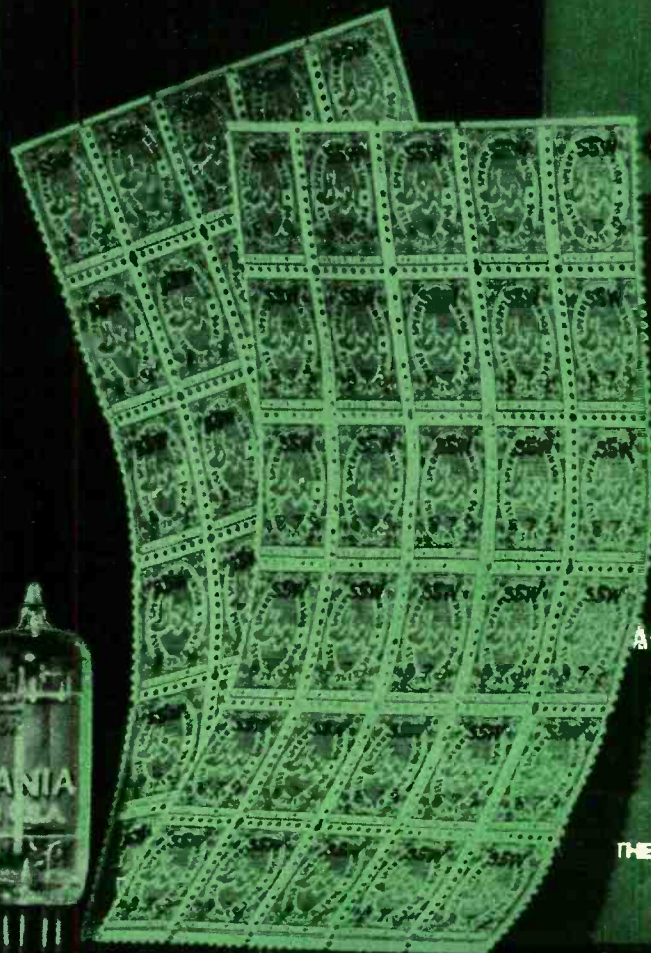

**GREEN
STAMPS**

America's Most Valuable Stamps

THE SPERRY AND HUTCHINSON COMPANY
ESTABLISHED 1896



S&H GREEN STAMPS...with the Service 'n Save Plan

Here's another big reason to go with Sylvania. S&H Green Stamps, exclusive with participating Sylvania Distributors, are given free to dealers with the purchase of Sylvania receiving tubes. They add up fast, especially when they're combined with stamps from the grocer and other merchants who give S&H Green Stamps. And the family can select gifts from a 144-page S&H Catalog full of everything from home furnishings to furs.

GO WITH SYLVANIA—TO PROFIT!

SYLVANIA

SUBSIDIARY OF

GENERAL TELEPHONE & ELECTRONICS



SERVICE 'N SAVE



By JACK DARR



It's FUN To Build THIS SUPERLATIVE SCHOBER ORGAN

EASILY ASSEMBLED
...AT HALF THE USUAL COST!

If you're the slightest bit handy and enjoy working with your hands, here's a remarkable project that will excite your imagination and reward you with a superb musical instrument. It's an opportunity to assemble your own Schober Electronic Organ—and—if you wish—create a unique console for it.

No special knowledge or skill is needed to assemble this electronic organ. Schober provides simple, step-by-step instructions (and woodworking drawings if you want to build your own console) to guide you every step of the way. Best of all, by assembling the organ yourself, you save half the usual cost... save even more if you make the console, too.

Imagine—this beautiful instrument with magnificent pipe organ tone and two keyboards. Who'd ever think it was so easy to build? Here is a work of art to be enjoyed today and treasured in the years to come.

Modern electronic kits containing every needed part—and the miracle of printed circuitry—make it possible.

With all work requiring knowledge or experience in assembling the instrument eliminated—all that's left is the pride and pleasure of watching this magnificent organ take shape under your own hands. If you can follow clear, non-technical instructions, you can build it.

Simply mail the coupon for details. No salesman will call.



THE *Schober Organ*
CORPORATION

Dept. RE-25, 43 West 61st St,
New York 23, N.Y.

THE SCHOBER ORGAN CORP.
DEPT. RE-25
43 WEST 61ST STREET, NEW YORK 23, N.Y.

- Please send me FREE booklet and other literature on the Schober Organs.
- Please send me the Hi-Fi demonstration record. I enclose \$2 which is refundable when I order my first kit.

Name _____

Address _____

City _____ Zone _____ State _____

using shielded cables

IN AUDIO WORK, CERTAIN "LOW-LEVEL" circuits must be kept isolated as much as possible. These include grid, volume-control, mono and stereo pickup leads. A low-level circuit is one which is connected to the input of high-gain audio stages so that any noise or hum picked up by the wire will be amplified many times. To prevent this, we surround the wire with a woven metal shield. The interference is picked up by the shield and kept out of the sensitive circuit.

In most cases the shield is grounded to the chassis. In some special cases, the shield should be grounded at only one end. This prevents the formation of "hum loops" caused by currents flowing through chassis and shield. Shielding should never be used for a return path for current-carrying circuits. The currents flowing through the shield can cause hum and other noises, by induc-

tive transfer to the "hot" or shielded wire.

There are a few tricks which will be of assistance to the experimenter when handling shielded cable. The photos show some of them.

The proper way to make a pigtail on shielded cable is shown in Photo 1. Bend the wire sharply at the point where the pigtail is to be made. Using a sharp-pointed pick, work the fine strands of

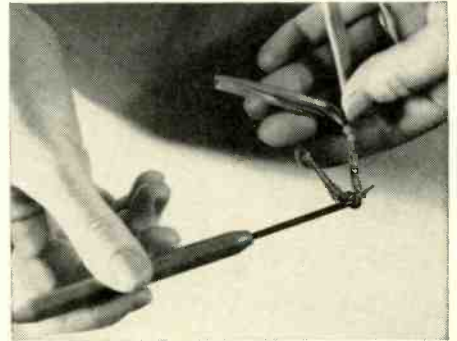

Photo 1

the shield apart and pull a loop of the inner conductor out through the hole. In this way, the shield remains "braided" and will make a much neater joint, as the strands will not frazzle out.

Photo 2 shows shielded cable "fanned" for making a joint. This is slightly exaggerated for purposes of illustration. This is two-conductor shielded cable that might be used for stereo pickups. In use,

HIGH SCHOOL "GRADS"

You don't need college to have a fascinating job, a bright future, big pay and advancement.



Those who don't know the facts say that only the college trained men get the good jobs in industry. Wrong! But it is true that the average high-school graduate gets only the poorest kind of job—

unless he has additional training in a specialized field.

For these men the biggest and fastest growing field open today is Electronics—all branches. Jobs are looking for men. You can train in as short a time as 35 weeks in the Electronic Labs of Coyne in Chicago, the Electronics Center of the Country. Most of your tuition can be paid after you graduate.

Like the great universities, Coyne School is an educational institution not for profit. A Coyne diploma gives you high standing with employers. Coyne graduates hold top jobs in Electronics all over the world.

See how little it costs to get the training you need. Don't put it off. Make your own decision. Send us your name, address now—this coupon or a postcard will do. No salesman will bother you at your home. All information is FREE.



Coyne Electrical School, Chicago 7, Ill., Dept. A3-N

Coyne Electrical School, Dept. A3-N
1501 W. Congress Pkwy., Chicago 7, Ill.

Please send Free Book "Your Opportunities in Electronics." I am under no obligation—no salesman will call at my home.

Name _____ Phone No. _____

Address _____

RR No. or Zone _____ State _____

City _____

"NO BOOSTER"
solution to
UHF
problems

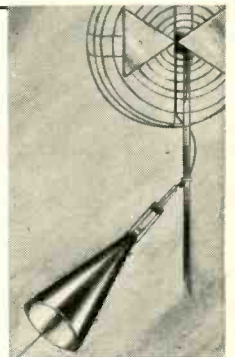

"G-Line"

TV servicemen can now substantially extend the range of UHF reception with this new, inexpensive, single-wire, low loss transmission line—only 6 db for 500 ft.

Complete kit includes 150 feet of special wire... List Price... \$56.00
Extra 100 ft. rolls... \$8.00 per roll.

Write for "G-Line" Catalog of
"NO BOOSTER" CATV (up to 4-mi.);
also Microwave and Hi-Power lines.



SURFACE CONDUCTION, INC.
1501 BROADWAY
NEW YORK 36, NEW YORK

RADIO-ELECTRONICS

the shielding would be tacked to the chassis as close to the connection as possible. To connect shielded wires to the small phono plugs, the center conductor

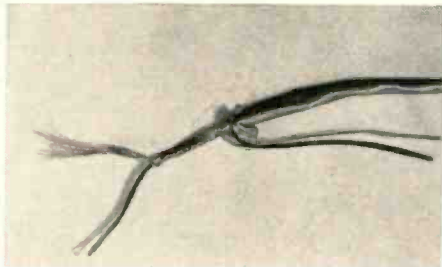

Photo 2

goes to the pin while the shield is wrapped around the groove in the outer shell of the plug.

Three steps in splicing shielded cable are shown in Photo 3. Bottom, wires are prepared. Shield is fanned out and wires clipped off about 1/2 inch (to allow shields to overlap) and a simple lap joint is made. Center, a short piece of braided spaghetti has been slipped over the bare wires. This should be put on

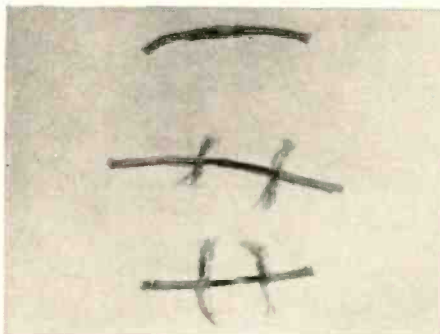

Photo 3

before soldering wires. (It was left off in the first view to show the joint.) Top, completed joint; shield braids have been overlapped and very lightly tacked with solder in several places. To make this joint properly, solder lightly. Never leave soldering-iron tip on joint long enough to overheat the plastic insulation of center conductor. This can cause shorts.

Photo 4 shows microphone cable, a jacketed shielded cable prepared for connection to an Amphenol type microphone plug. Note the method of strip-

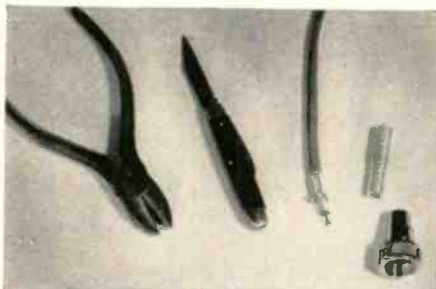
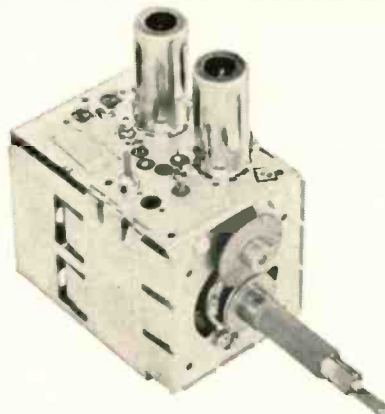

Photo 4

ping wire back. The center conductor is tinned before insertion into the plug at right. The small spring provides a ground for the shield. The shielding braid is tack-soldered to the end of this. It also helps prevent cable breakage at the plug. END

Prices effective January 1, 1963

Tarzian offers
**FAST, DEPENDABLE
TUNER REPAIR
SERVICE (ALL MAKES)**



It just makes sense that a manufacturer of tuners should be better-qualified, better-equipped to offer the most dependable tuner repair and overhaul service.

Sarkes Tarzian, Inc. pioneer in the tuner business, maintains two complete, well-equipped Factory Service Centers—assisted by Engineering personnel—and staffed by specialized technicians who handle ONLY tuner repairs on ALL makes and models.

Tarzian-made tuners received one day will be repaired and shipped out the next. Allow a little more time for service on other than Tarzian-made tuners.

Tarzian offers a 12-month guarantee against defective workmanship and parts failure due to normal usage. And, compare our cost of \$9.50 and \$15 for UV combinations. There is absolutely no additional, hidden charge, for ANY parts except tubes. You pay shipping costs. Replacements on tuners beyond practical repair are available at low cost.

Ⓢ Tarzian-made tuners are identified by this stamping.

When inquiring about service on other tuners, always give TV make, chassis and Model number. All tuners repaired on approved, open accounts. Check with your local distributor for Sarkes Tarzian replacement tuners, replacement parts, or repair service.

SARKES TARZIAN, INC.
Bloomington, Indiana

MANUFACTURERS OF TUNERS . . . SEMICONDUCTORS . . . AIR TRIMMERS . . . FM RADIOS . . . AM/FM RADIOS . . . AUDIO TAPE . . . BROADCAST EQUIPMENT

ONLY
\$9.50
INCLUDING

ALL PARTS
(except tubes)
and LABOR

**24-HOUR SERVICE
1-YEAR WARRANTY**

**TWO SERVICE CENTERS
TO SERVE YOU BETTER**

See your distributor, or use the address nearest you for fast factory repair service

537 South Walnut St.
Bloomington, Indiana
Tel: 332-6055

10654 Magnolia Blvd.
North Hollywood, Calif.
Tel: 769-2720

E.V. HORN TWEETER \$12.95
2 for \$22.50

Famous MOD. 8HD complete with 2-lb. DRIVER

NEW—GM TRANSCEIVER

All Metal Case. Plug-in Crystals. 9 Transistors. **\$29.95**

For Better Ground. Less than 2 \$35 ea.

GM's Top Quality. High Efficiency CB Unit—Equipped with Channel 11 Plug-In Crystals. Includes: cases, earphones, batteries. Order yours today. Free Catalog

GM PHOTOELECTRONICS
623 So. Gay Street Knoxville 2, Tenn.

CONVERT TO COLOR TV



COLORDAPTOR—A simple 10-tube circuit and rotating color wheel converts any size B & W TV to receive compatible color.

COLORDAPTOR — Easily attached to any TV set, does not affect normal operation, often built from parts experimenters have on hand. **BRILLIANT COLOR!**

Complete booklet—gives theory of operation, all construction details, schematic, and sample color filters. **\$1.95**

Essential Parts Kit—Includes all special parts—coils, delay line, crystal, color filters. Add \$1.00 for sets over 16". **\$19.95**

COLORDAPTOR 1798 Santa Cruz, Menlo Park, Calif.

WHY THE *Winegard*

COLORTRON

DESIGNED ESPECIALLY FOR COLOR TV

Genuine **GOLD ANODIZED** Finish
for permanent protection

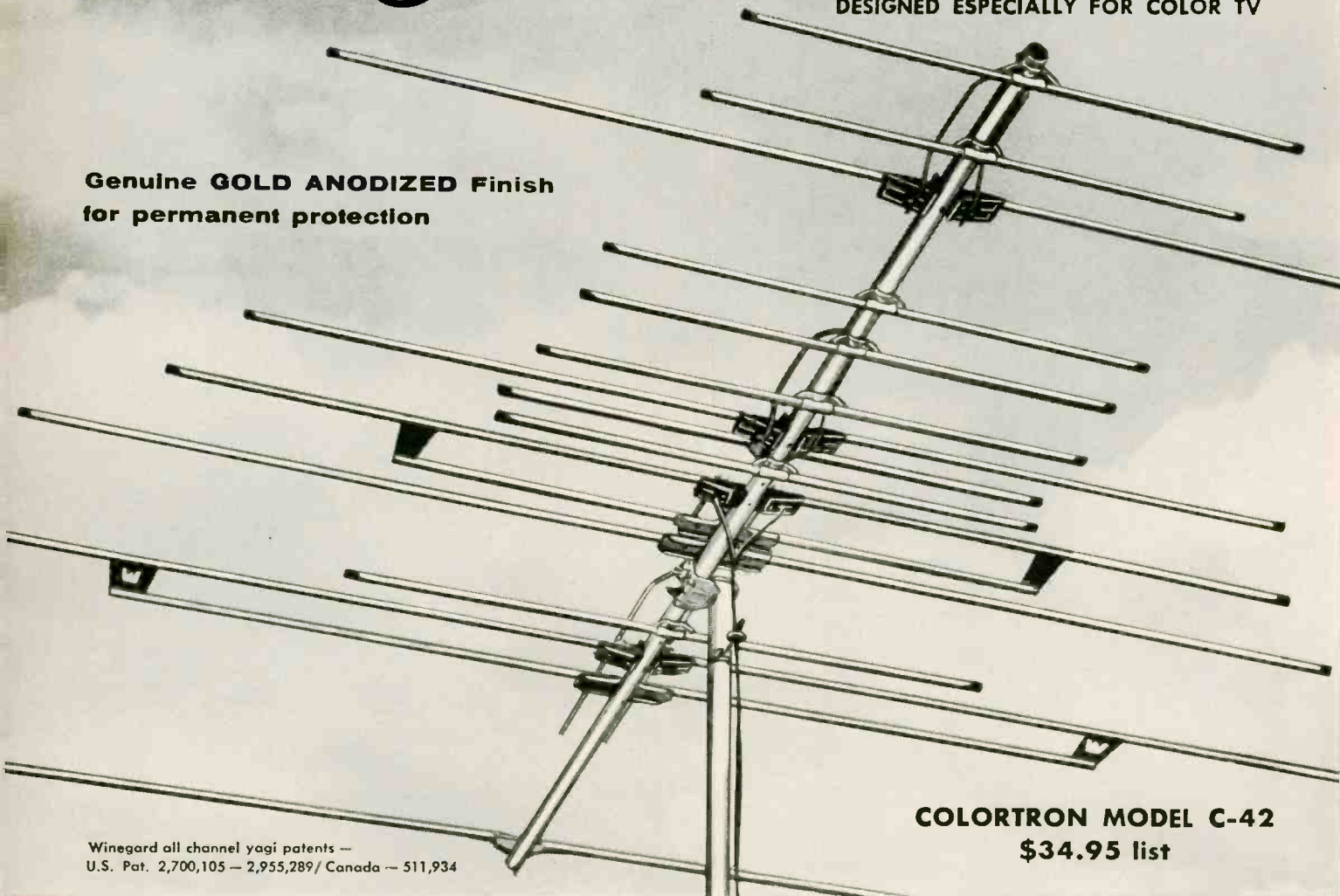

COLORTRON MODEL C-42
\$34.95 list

Winegard all channel yagi patents —
U.S. Pat. 2,700,105 — 2,955,289 / Canada — 511,934

The world's BEST performing VHF all channel TV antenna, size for size and dollar for dollar, is the Winegard Colortron. The Colortron is more nearly perfect than any other all channel antenna made. It is the only all channel antenna you can buy that carries a factory written guarantee of best performance.

HERE'S WHY COLORTRON IS BEST

1. A perfect all channel, high gain TV antenna would have the following characteristics:

—the sensitivity of a well-engineered cut channel yagi of equal physical length on each of the 12 channels.

—sharp directivity. A single frontal lobe and absolutely no pick-up of signal from back or sides on any channel.

—it would have an exact 300 ohm non-reactive impedance on every VHF channel 2 through 13.

2. There are several basic designs for high gain, all channel TV antennas. For practical reasons, only two of these are used today.

(A) The *all channel yagi* that incorporates only 2 driven elements—but *many* directors. This design was invented by John R. Winegard in 1954. Until then, the high efficiency of the yagi was limited to single channel antennas.

(B) The all channel antenna that incorporates a *multiplicity of driven elements* in a single plane. These are *End-Fire* arrays.

This basic design was first used for TV in 1952. Some end-fire antennas are called "log periodic".

IT IS A SCIENTIFIC FACT that a single $\frac{1}{2}$ wave director element* will absorb 4 times more signal energy from a TV wave than a $\frac{1}{2}$ wave driven element**. Because of this indisputable fact, the Winegard Colortron all channel yagi uses multiple *directors* to get its gain—not multiple driven elements.

To obtain a near perfect impedance match across the entire VHF TV band, it takes only two driven elements. More than two driven elements will not improve the match any more than extra wheels would improve a car. The only purpose of driven elements on a TV antenna is to transfer the signal energy to the line.

As every antenna engineer knows, a well-engineered cut-to-channel *yagi* (with but *one* driven element and *many* directors) is superior to any other design when peak performance is desired on a single channel. The same fact holds true for best results in all channel reception . . . the yagi design is the most efficient, sensitive ever created on a size for size basis.

*Directors are elements connected electromagnetically (not by means of phasing lines) to the driven elements.

**Driven elements are connected together with phasing lines and the transmission line is attached to these elements.

Antenna is World's BEST

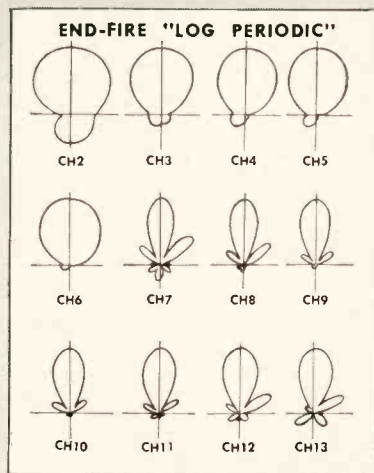
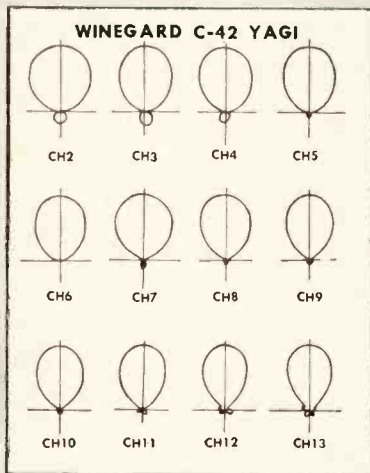

COMPARE POLAR PATTERNS

WINEGARD C-42 YAGI. Polar patterns from Polar coordinate Recorder Speedomax Type G.

NOTE uniform directivity patterns and high uniform front-to-back ratio on all channels. NOTE absence of spurious lobes and total absence of side pick-up.

END-FIRE "LOG PERIODIC" model comparable with C-42. Polar patterns taken from same recorder.

NOTE large variation between directivity from channel to channel. NOTE reduced front-to-back ratio from C-42. NOTE spurious lobes (especially on high band) which pick up interference. Also has undesirable side pick-up on low band.

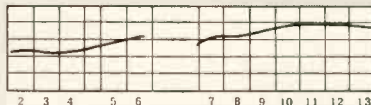

COMPARE FREQUENCY RESPONSE CURVES

WINEGARD C-42 YAGI shows consistent sensitivity across all channels. No roll-off on ends of bands, no suck-outs to ruin color reception.

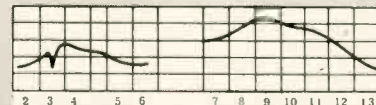

END-FIRE "LOG PERIODIC" (in same price range) shows varying sensitivity across the bands. Peaks in middle of bands with sharp roll-offs on ends. Serious suck-out in middle of channel 3.

NOW WHAT ARE THE BASIC DIFFERENCES BETWEEN THESE TWO TYPES OF ALL CHANNEL ANTENNAS?

One big difference is in **SENSITIVITY**. The Winegard Colortron patented yagi with multiple *directors* has far more ability to absorb signal power from a TV wave than multiple driven element antennas. In fact, *all* fringe-type antennas with multiple driven elements have *one or more* directors out front. Why add directors if the multiple driven elements are supposed to be so efficient? The reason is obvious . . . directors are added to get the gain they can't get with extra driven elements.

Another big difference is in **DIRECTIVITY**. The Winegard Colortron patented yagi has far better directivity characteristics than multiple driven element antennas and the *directivity pattern is essentially the same on every channel*. The Colortron has *no* signal pick-up from the sides (as you can see above). It offers no receiving surface to side signals and has no complex phasing problems to cause extra pick-up lobes. It has *minimum* pick-up from the back.

On the other hand, multiple driven element antennas have large side lobes because the driven elements are always out

of phase at some frequencies in the TV band—particularly on the high band.

The Winegard Colortron excels, too, by having the *best 300-ohm match in the industry*—an average VSWR of better than 1.5 to 1 across both bands.

In addition to its performance superiority, the Winegard Colortron has the finest quality construction and *permanent gold* anodizing for weather protection. A personal examination of a Colortron tells this quality story far better than words.





(The polar patterns and frequency response curves above have been illustrated to give you a basis of comparison between Winegard's popular Colortron Mod. C-42 and a highly advertised multiple driven element antenna which we have tested (along with other models in this line.) Constant testing of *all* new outdoor TV antennas proves to our satisfaction that no other design equals or excels the Winegard Colortron in quality or performance. We are so positive of this performance superiority that we put a written guarantee on it.

For technical data sheets write today!

Nationally advertised month after month.

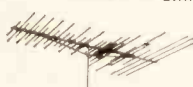

There's an Extra Bonus of Quality and Performance in Every Winegard Product

			
COLORTRON ANTENNA Model C-44—Gold Anodized \$64.95	COLORTRON ANTENNA Model C-43—Gold Anodized \$51.90	COLORTRON ANTENNA Model C-42—Gold Anodized \$34.95	COLORTRON ANTENNA Model C-41—Gold Anodized \$24.95



Winegard

ANTENNA SYSTEMS

3013-6 KIRKWOOD • BURLINGTON, IOWA

equipment report

Cantenna Dummy Load

(Heathkit HN-31)

and

Transistor DC Multimeter

(Motorola S1052B)

MANY SERVICE TECHNICIANS HOLDING FCC licenses service CB, police, emergency, commercial and amateur transmitters. For this a nonradiating dummy load to permit off-the-air testing is essential. Appropriate dummy loads, particularly those with reactances low enough to be suitable for the spectrum above 25 mc, are scarce and expensive. The Heathkit "Cantenna" dummy load presents a highly satisfactory solution at a modest price.

The Cantenna (see Fig. 1 and the photograph) consists of a nonreactive 50-ohm resistor (R1) plus a diode rectifier to permit reading the voltage developed across it. The resistor is a car-

borundum type with silver-plated ferrules at each end. By itself it has negligible reactance at any frequency below the kilomegacycle range. It is cleverly mounted in a coaxial mount with silver-plated straps so that there is a minute amount of inductance or capacitance. This assembly fits into an ordinary 1-gallon "syrup can" filled with transformer or mineral oil to cool the resistor. (The oil is not supplied with the kit.)

The circuit for measuring the voltage consists of a voltage divider (R2, R3) and a diode and is contained in a little shielded box on the lid. There is a large coax fitting to accept a cable from the transmitter and a phono jack for a voltmeter or vtvm.

The dummy can be used with rf power up to 1 kw. Fig. 2 gives the range of power vs the time the load can be safely used. Heathkit specifies a vswr of less than 1.5 up to 300 mc and less than 2 up to 400 mc.

The Cantenna kit is extremely simple to put together. A little over an hour

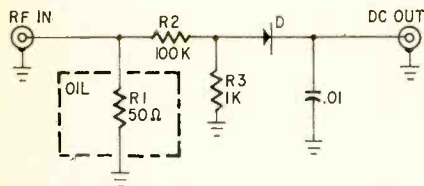
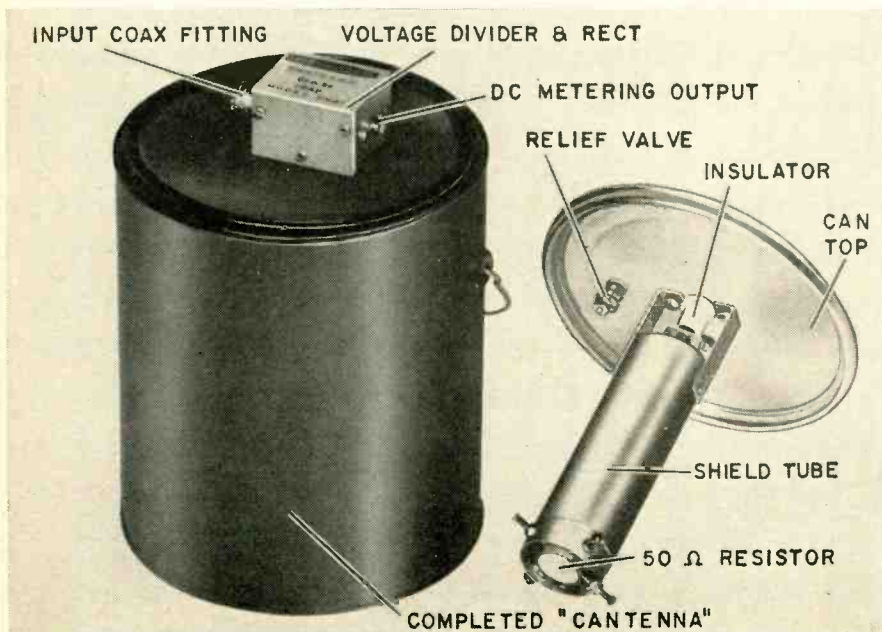

Fig. 1—Schematic of the dummy load.



At left, completed dummy load. At right, details of "insides".

does it, and it requires no calibration or adjustment of any sort. If you need a fairly accurate measure of the rf voltage developed across the load, it will be necessary to calibrate the dc output of the diode with a reliable rf voltmeter. In most cases a relative indication of power output is sufficient, and no calibration is required. The dc output is from less than 1 volt to around 20 volts, depending on the power.

The resistor has a 10% tolerance but the one in our sample measured very close to 50 ohms. By our measurements, the swr was practically 1.00 below 30 mc, hence the Cantenna can be used to calibrate an swr bridge. As a matter of fact, in the 6-meter band the swr was in the region of 1.1. Hence little error would result if it were used as a calibration standard even there. The swr in the 2-meter and the 150- to 170-mc commercial band measured about 1.25.

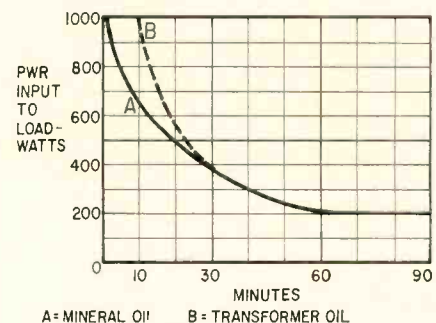

Fig. 2—Dummy antenna can handle full kilowatt for short time, up to 200 watts indefinitely.

Within the specified range the Cantenna is one of the most nonreactive loads available. It is well enough shielded so that at power levels up to 250 watts (the highest available for tests) there was negligible radiation. It should be a highly useful accessory for any service shop that works with transmitters requiring a load in the 50-ohm region.—Joseph Marshall

The S1052B

HERE'S A DANDY LITTLE INSTRUMENT that is completely portable, yet gives accurate measurements of rf voltages, dc voltages, direct current and resistance. A cable and power supply are available to operate the meter from an ac supply. With an rf probe, rf signals from 1 kc to 400 mc can be measured.

Three input arrangements are used when measuring voltage, current or resistance. For voltage, the arrangement shown in Fig. 3 is used. It is a voltage divider made up of a series of resistances in ratios of 1, 3, 10, 30, 100, etc. Taps on the attenuator, corresponding to the range selector switch settings, apply a dc voltage to the amplifier input through an overload protection circuit.



Tips for Technicians

Mallory Distributor Products Company
 P.O. Box 1558, Indianapolis 6, Indiana
 a division of P. R. Mallory & Co. Inc.

Replacing selenium with silicon rectifiers

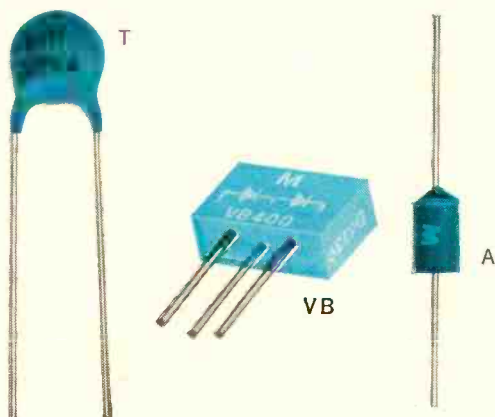
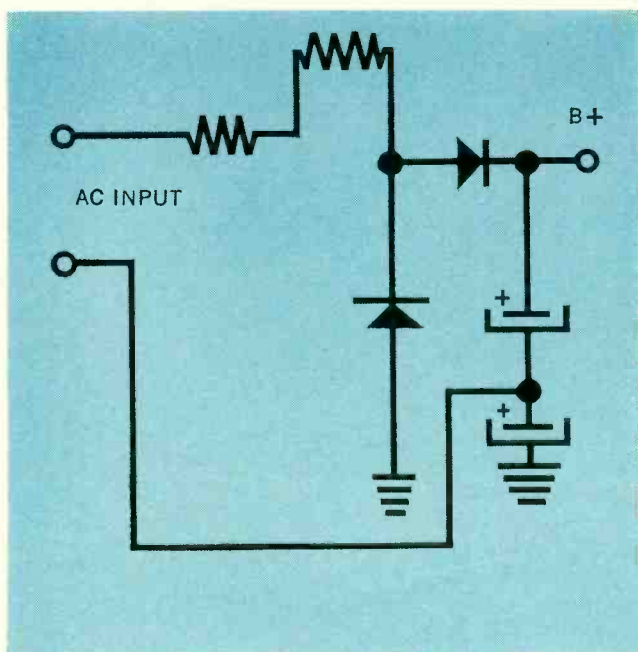

Ever wonder about replacing those old selenium rectifiers with modern silicon rectifiers? Stop wondering. It's being done every day and you can do it too! Take a typical TV voltage doubler circuit for example.

1. You know the seleniums are bad or you wouldn't have started . . . right? Right.

2. Forget about the terrific size difference between the new silicons and those old seleniums. Silicons are smaller because they're *much* more efficient.

3. Remove the old seleniums and toss 'em in the trash can. Install the new silicon rectifiers **FOLLOWING POLARITY VERY VERY CAREFULLY**. The slick way is to use a Mallory VB500 (you'll have one less solder connection to make and the circuit is right on the rectifier). Or you could use a pair of 1N2095's or A500's. Either way those Mallory rectifiers will give you the *best* service you'll ever get.

4. Output voltage (B+) will *usually* be higher because silicon rectifiers are more efficient. So, you'll probably need a dropping resistor in series with the one already there. Turn the set on and check with a voltmeter. Suppose B+ reads 20 volts higher than the schematic calls for. Divide this increase by load current (perhaps 500 ma) to get the value of the resistor you'll need. (40 ohms in this case.) Now multiply the voltage increase by current to get wattage rating (10 watts in this case).

5. But suppose B+ voltage *isn't* higher. This is a clue that something's wrong with the filter capacitors. Check them out with a capacitance bridge or try this very simple deal. Parallel a good TC62 (10 mfd @ 350 WVDC) across each filter in turn. If you get a marked B+ increase you need some replacement electrolytics. We'd suggest a Mallory FP, WP, W, or TC of the proper rating.

6. If you'd like a lot more detail on this replacement arrangement, drop us a line and we'll send a folder by return mail. Meanwhile see your Franchised Mallory Distributor for all Precision Mallory Components . . . batteries, capacitors, controls, switches, resistors, semi-conductors and vibrators.

Win with **EMC**



By far the **BEST VALUE** obtainable in either wired or kit form . . . compare and you'll agree "THE BEST BUY IS EMC."

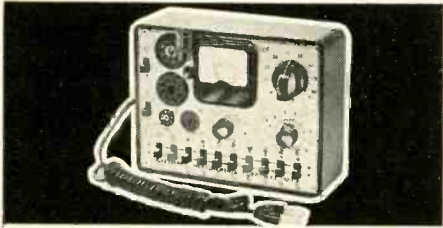

EMC Model — 211 Tube Tester — The smallest, lowest priced, domestic made tube tester on the market. It is completely flexible and obsolescent proof. It checks each section of multi-purpose tubes separately, checks all octal, loctal, 9 prong and miniature tubes for shorts, leakages, opens, intermittents as well as for quality. Quality is indicated directly on a two color meter dial using the standard emission test. Comes complete with instructions and tube charts in ring bound manual. Size 6 3/4" x 5 3/4" x 2 1/4" deep. Shipping weight: 3 lbs.

Wired	Kit	\$14.90
CRT Picture Tube Adapter		\$ 4.50

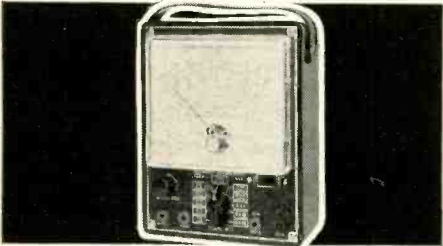

EMC Model 109 — Voltmeter — Features 20,000 OHMS volts DC sensitivity and 10,000 OHMS per volt AC sensitivity. Uses a 4 1/2, 40 microampere meter, with 3 AC current ranges, and 3 resistance ranges to 20 megohms. 5 DC and AC voltage ranges to 3000 volts and 3 DC current ranges; also 5 DB range.

Model 109 — With carrying strap, Weight 2 lbs. 5 ozs.; Size: 5 1/4" x 6 3/4" x 2 7/8" \$26.95
 Model 109K — Kit Form 19.25
 Model HVT — 30,000 Volt Probe for Model 109 7.95



EMC Model 107A — Peak to Peak Vacuum Tube Volt-Ohm Capacity Meter — 6" meter cannot burn out — entirely electronic. Measures peak to peak AC voltages to 2800 volts in 6 ranges. Measures capacity in 6 ranges from 50 mmfd to 5000 mfd. Measures resistance in 6 ranges from .2 ohm to 1000 megs. Measures DC volts to 1000 volts in 6 ranges. Input resistance to 16.5 megs. Wired \$51.40 Kit \$36.50

Yes, tell me more, send me **FREE** a detailed catalog of the Complete EMC Line. Dept. RE-663

NAME
 STREET
 CITY STATE

EMC Electronic Measurements Corp.
 625 B'way, New York 12, N. Y.
 Ex. Dept., Pan-Mar Corp., 1270 B'way, New York 1, N. Y.

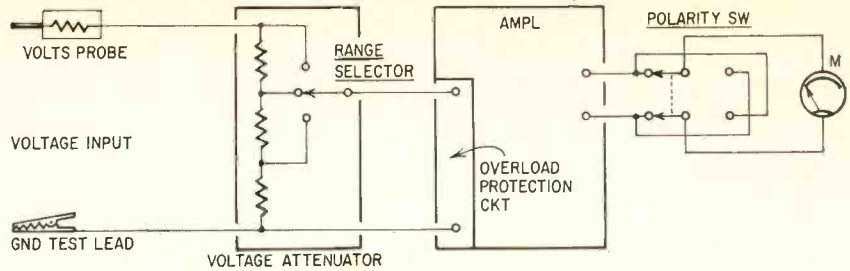

Fig. 3—Functional diagram of the transistor meter. Attenuator and probe shown are for voltage measurements.



Motorola's S1052B—a compact and versatile instrument.

For measuring current, the input circuit changes to the arrangement shown in Fig. 4-a. Now there is a series of shunt resistances through which the measured current flows. The resulting voltage drop across the shunt in use is applied to the amplifier input. A 100-mv drop across the shunt gives a full scale meter reading. Half-watt resistors are used for the 1- μ a to 3-ma ranges and 1-watt resistors for all other current ranges.

For resistance measurements, the input circuit is different again (Fig. 4-b). Here the voltage from the battery in the meter is reduced by a voltage divider. This gives about 0.15 volt in series with 10 ohms on the R \times 1 scale. Additional resistors are inserted in series with this basic 10-ohm resistor on the higher ranges.

The heart of the instrument is a 10-

SPECIFICATIONS

Voltage ranges (11 megohms input resistance): 0-100; 300 mv; 0-1, 3, 10, 30, 100, 300, and 1,000 volts

Current ranges: 0-1, 3, 10, 30, 100 and 300 μ a

0-1, 3, 10, 30, 100 and 300 ma

Resistance ranges: 10, 100, 1000, 10,000, 100,000 and 1 megohm center scale

Accuracy: voltage ranges, 3% of full scale current ranges, 3% of full scale resistance ranges, 5% at center scale

Meter: 0-200- μ a movement.

Weight: 7 1/4 lb

Size: 10 1/4 x 6 1/2 x 5 3/4 inches

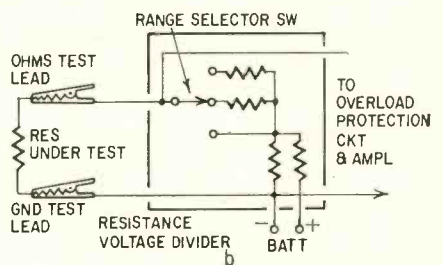
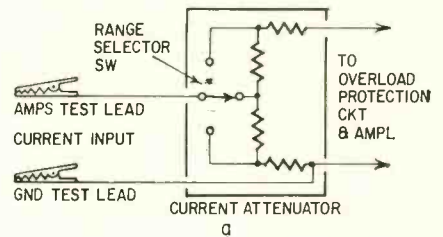

Fig. 4—Other functions differ only in attenuator configuration. (a) shows setup for current measurements, (b) for resistance.

transistor amplifier consisting of five differential direct-coupled push-pull stages. There is 60 db of negative feedback to insure stable gain. The feedback also increases the amplifier's input impedance to reduce loading on the multimeter's high-impedance input circuitry. Because of its design, the amplifier can handle both negative and positive voltage inputs.—Warren Roy

New!

INTERNATIONAL

A* O C

* Add
On
Circuits

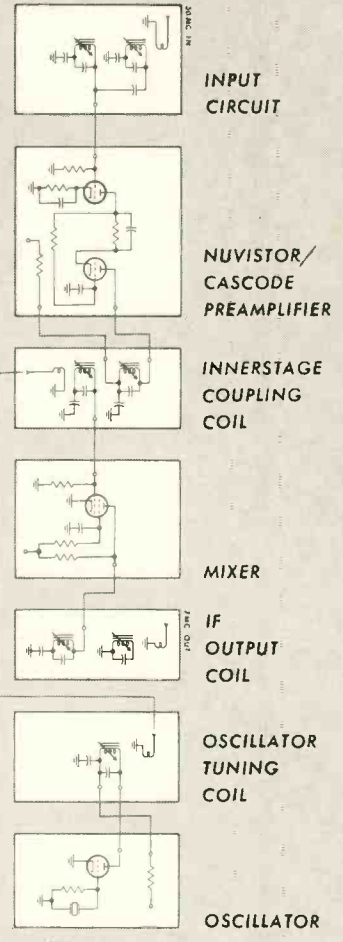
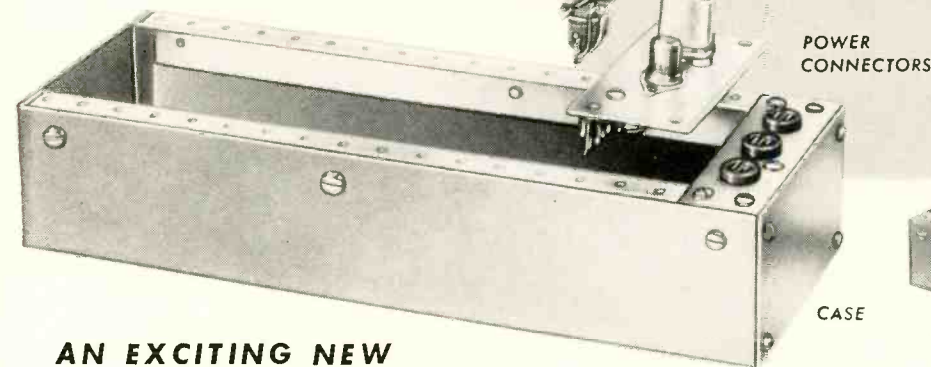

AN EXCITING NEW APPROACH TO DESIGN AND CONSTRUCTION, AM • FM • SSB • DSB

The amateur, experimenter, and hobbyist will discover a new and easier way to build a wide variety of communication and electronic gear with International AOC units . . . individually wired oscillators, preamplifiers, detectors, etc., each tested and mounted on miniature metal chassis.

For example, the eight AOC units (illustrated) have been assembled to make a 6 meter converter. Each circuit may be removed to make modifications, or build other equipment.

AOC units permit custom building for a wide range of frequencies, modes, and power. RF coils are available from 200 kc to 450 mc. IF transformers are available from 262 kc to 10.7 mc. Transmitter power to 100 watts. Matching cases from 4 to 16 inches in length, complete with hardware.

If you are planning to build a receiver, transmitter, converter, or other electronic equipment use International AOC units.

AOC units are moderately priced from.....\$2.00 up.

- PREAMPLIFIERS • MIXERS • OSCILLATORS • INTERMEDIATE FREQUENCY AMPLIFIERS • DETECTORS • DISCRIMINATORS • BUFFERS • POWER AMPLIFIERS • MODULATORS • FREQUENCY MULTIPLIERS • SPEECH AMPLIFIERS • RECTIFIERS • REGULATORS • POWER TRANSFORMERS • OSCILLATOR BRIDGES**



18 NORTH LEE • OKLAHOMA CITY, OKLAHOMA
JUNE, 1963

**FOR
COMPLETE
DETAILS
MAIL COUPON
TODAY!**

International Crystal Mfg. Co., Inc.
18 North Lee
Oklahoma City, Oklahoma
Please rush details on AOC units.
City _____ Zone _____ State _____
Name _____
Address _____

column speaker enclosure

COLUMN SPEAKERS (COLUMN-TYPE speaker enclosures with a vertical array of four or more speakers) are generally used in PA work and in background music systems where the performance or appearance of horns is objectionable.

When the speakers are in a vertical row, the enclosure produces a radiation pattern with a wide horizontal angle and a narrow vertical angle. When mounted at a carefully selected height in an auditorium or concert hall, the narrow beam passes over the heads of those closest to the stage and gradually becomes more effective for those farther back.

The diagram shows construction details of a 36-inch column enclosure described in *Radio, Television & Hobbies* (Sydney, Australia). The unit was designed for five 6-inch dual-cone speakers for wide-range performance.

Major parts are cut from a 3 x 4-foot sheet of $\frac{5}{8}$ - or $\frac{3}{4}$ -inch plywood with hardwood veneer. The $5\frac{5}{8}$ -inch speaker holes are laid out along the center line and spaced as shown. The $\frac{3}{16}$ -inch vent holes are drilled in vertical rows that just clear the speaker frames. The top, bottom, sides and front are held together with glue and screws in 1-inch square battens. All inside surfaces except the front panel are lined with glass fiber or other sound-absorbing material and a curtain of similar material is draped loosely around the speakers.

The end grain on the front of the enclosure can be covered by the molding holding the grille cloth. The end grains of the top and bottom edges are covered with $\frac{1}{4}$ -inch strips of matching hardwood or the top and bottom can be

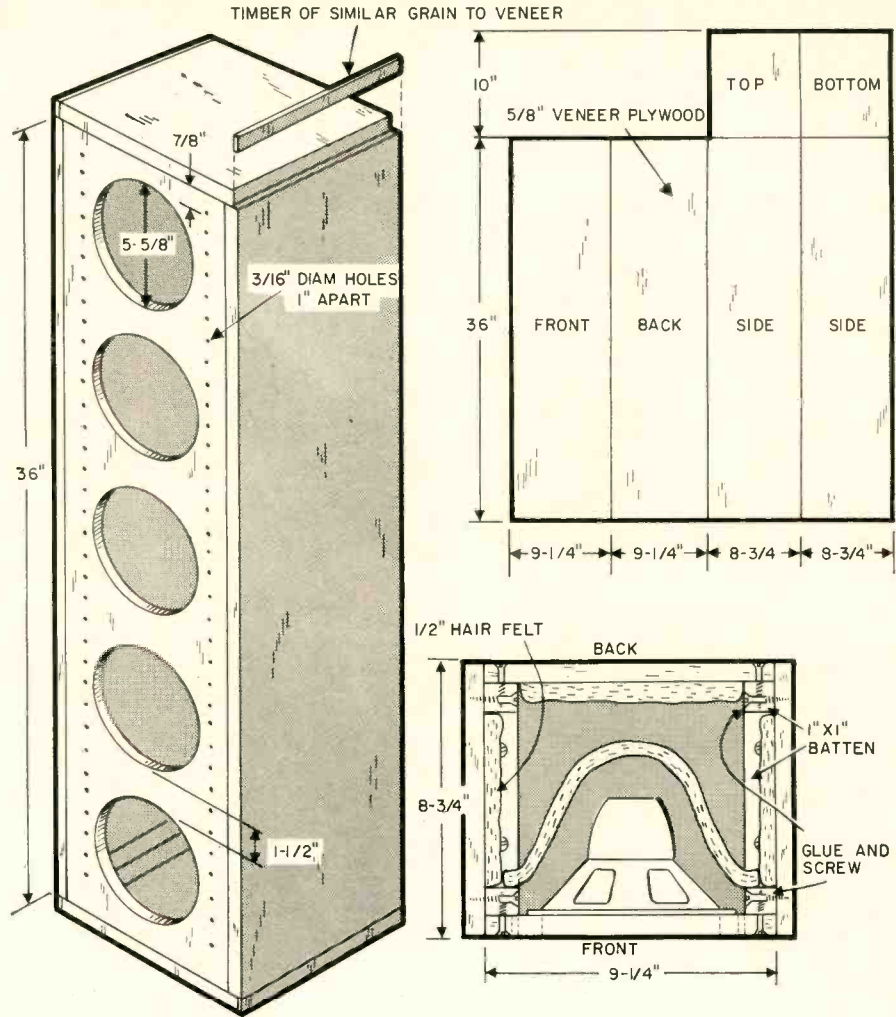

cut $\frac{1}{2}$ inch longer than specified and the ends covered with veneer tape. For information on exterior modifications

and finishing, see *Designing and Building Hi-Fi Furniture*, by Markell, Gernsback Library Book No. 79. END

Converting a recorder to slow speed

By I. QUEEN
EDITORIAL ASSOCIATE

MY WOLLENSAK T-1500 RECORDER HAS two speeds: 7.5 and 3.75 ips. I use 7.5 almost exclusively because of its better

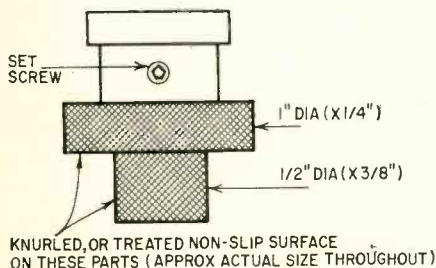

fidelity, particularly on music. Recently I considered the possibility of converting the slower speed to $1\frac{1}{8}$ ips. This would make the machine compatible with some of the new miniaturized recorders. Also, it would extend playing time for long speeches or radio programs. The conversion was not difficult.

The first step is to remove the white top panel, held by five painted screws and two plated screws on the perforated grill. Pry the panel at the rear to remove it. Now remove the pulley wheel (see figure) from the motor shaft. It has two rims, 1 inch for 7.5 ips and $\frac{1}{2}$ inch for 3.75 ips. Saw off the

bottom ($\frac{1}{2}$ -inch) portion, leaving the $\frac{1}{4}$ -inch motor shaft itself to drive the rubber idler wheel. This reduces the speed to $1\frac{1}{8}$ ips as desired. When you replace the sawed-off pulley, you have completed the conversion.

Your speed switch will now set the recorder to either 7.5 or $1\frac{1}{8}$ ips. The very low speed cannot offer the fidelity of faster speeds, but speech quality is remarkably good. Music does have some wow. The slow speed makes it possible to pack as much as 1 hour of playing time on a 3-inch reel.

Possibly other makes of tape recorders can be converted in a similar manner. END

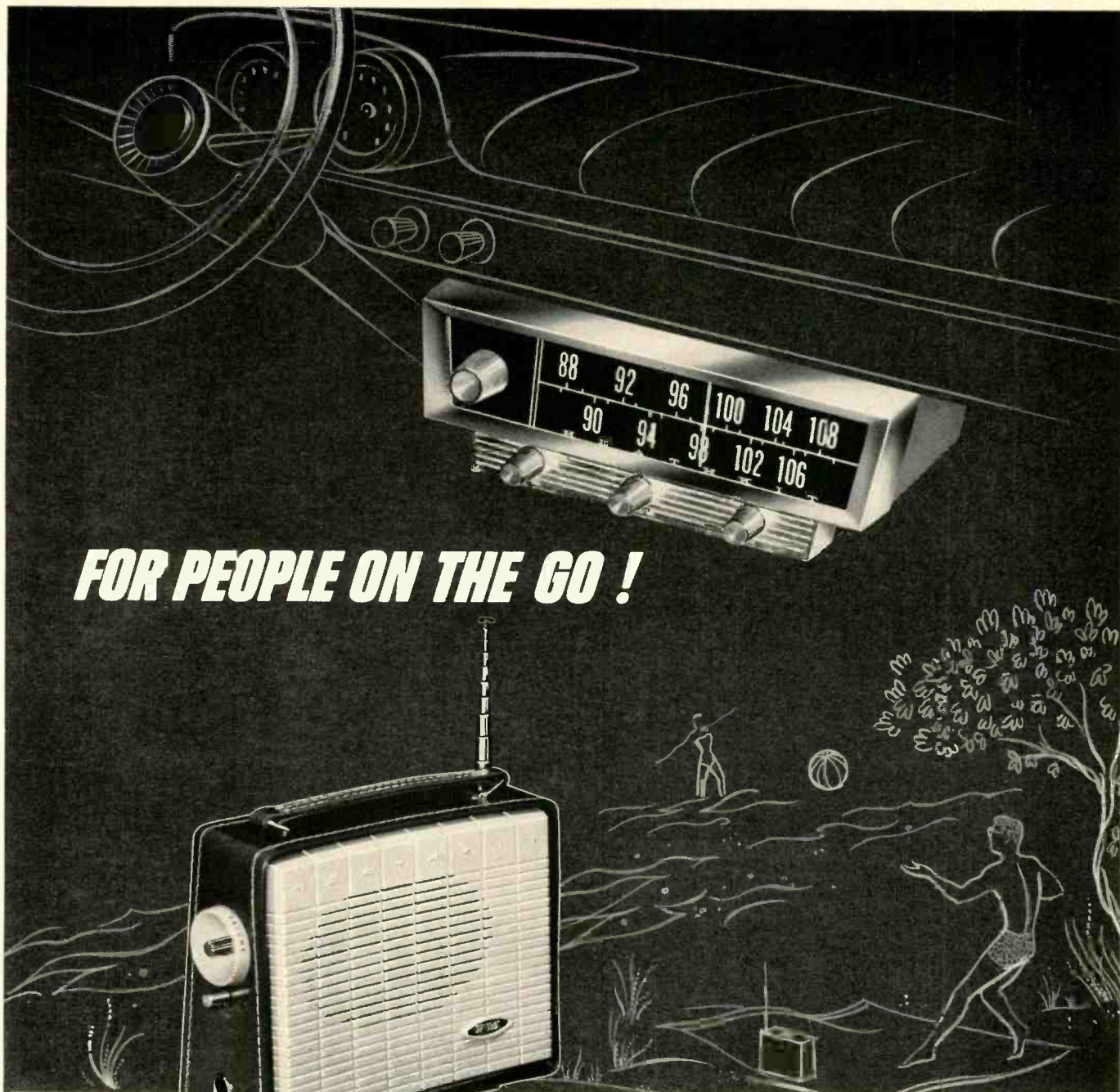

FOR PEOPLE ON THE GO !

**Heathkit FM radio -
the perfect companion**

Wherever you go . . . this summer or any season . . . take the finest in listening enjoyment with you. While driving, thrill to the static-free, full fidelity of the new Heathkit FM Car Radio. 10-transistor circuit: under-dash tuner with separate power amplifier delivers 10 watts at less than 1% distortion. (Kit GR-41, 7 lbs., for 12v. neg. gnd., \$7 mo., \$64.95) At the beach, in the cottage, or at home, the new Heathkit FM Portable Radio offers you sensitive, clear, quiet FM reception wherever you are. 10-transistor, 4-diode, battery-powered circuit: listen to its built-in speaker, use headphones, or connect it to your hi-fi system. (Kit GR-61, 6 lbs., less battery, \$5 mo., \$47.95)



HEATH COMPANY,
Benton Harbor 20, Michigan

a subsidiary of Daystrom

Please Send My FREE 1963 Heathkit Catalog

Name

Street

City Zone State

Prices & specifications subject to change without notice.
Dealer and export prices slightly higher.

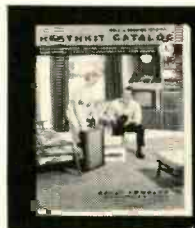

**FREE 1963 HEATHKIT
CATALOG**

Over 250 exciting do-it-yourself kits for Stereo/Hi-Fi, TV, Electronic Organs, Marine, Educational, Amateur Radio, Test & Lab, Home & Hobby. Easy to build, save up to 50%! Send for your free copy today.

1963 SEMI-ANNUAL INDEX

RADIO-ELECTRONICS

January-June, 1963 of Vol. XXXIV

A

Add Stereo to FM with This Simple Adapter (Williams)§	Feb 28
Amplifier	
Audio—See Audio	
Boosts Vom Sensitivity (Fasal)*§	Mar 32
Electro-optical Amplifier (NB)	Jun 8
Needs No Service	May 28
Antenna(s)	
CB, Put Maximum Power into (Stiebel)	May 30
FM, Has High Gain and Quality (Churchill)*	Mar 50
Log Periodic V (Finkel)	Jun 24
Rabbit-ear, Rubber Bumpers for (TTO)	Feb 94
Radar Cloverleaf (WN)	Jan 39
Rotor Pin, Emergency (TN)	Mar 100
Arc Lamp (PAT)	Apr 99

AUDIO—STEREO—HIGH FIDELITY (see also FM)

Amplifier(s)	
Fixed Bias in All Stages (Travis)*	Apr 24
Guitar, Vibrato for (NC)§	May 69
10 Watts, 8 Transistors (D'Airo)*§	May 44
Bias, Try Fixed, in All Stages (Travis)*	Apr 24
Bottom, Improving Hi-fi (Marshall)	May 49
Cables, Using Shielded (Darr)	Jun 62
Cartridges, Ceramic, Getting Best From (Burstein)	Jun 28
Crossover Network (Barbee) (Corres)	Jan 21
Earphone and Electret Mike (NB)	Feb 6
Enclosure, Hi-fi, from Old TV (West)	Jan 45
Hearing Aid in Aspirin Box (de la Roza)*§	Jan 37
Hi-fi Defined? (NB)	Feb 10
Hum, Puzzled About (Prasil)	Apr 58
Inverter, New Phase (NC)	Jan 111
Microphone, Electret (NB)	Feb 6
Mixer, Low-Noise (Pat)	Mar 104
Mixer-Preamp, Multipurpose 2-Channel (Schotz)*§	Mar 46
Music	
All Over House, Without Wires (Scott)	Jun 40
Corn Yield Upped (NB)	Jan 14
Electronic	Mar 34
Is Here (Essex)	Feb 48
Oscillator, Tape Recorder (Pat)	Apr 99
Output Circuit, Complementary Symmetry (Roy)	Apr 49
Outputs, Improving Single-ended (Mooney)	Apr 45
Preamp(s)	
Audio Voltmeter Doubles as (Stone)*§	Feb 32
Improved (Soukup)* (Corres)	Mar 24
Inboard, Boosts FM Tuner Sensitivity (Drenner)*	May 26
Mixer, Multipurpose 2-Channel (Schotz)*§	Mar 46
Record Changers and Players	
Converting 3-Speed to 16 rpm (TTO)	May 94
Needle Brush (TTO)	Mar 102
Servicing—See Servicing, Audio	
Speaker, Column Enclosure*	Jun 70
Speaker, Ionic (Pat)	Mar 104
Stereo	
Amplifier (Laurent)* (Corres)	Jan 18
Earphones for Hi-fi (Marshall) (Corres)	Jan 21
FM, Easy Way (Leslie)	Jan 68
10 Watts, 8 Transistors (D'Airo)*§	May 44
3-Speaker (Pat)	Jun 99
Tape Recorder(s)	
Changer, New Automatic	Feb 27
Convert to Slow Speed (Queen)	Jan 70
Duplicates Tapes (WN)	May 43
Oscillator (Pat)	Apr 99
Playback Electron Cloud Head	Mar 41
TV Sound, High-Fidelity (Gernsback) (Corr)	Feb 62
More On	Mar 47
Vibrato for Guitar Amplifier (NC)§	May 69
Voltmeter Doubles as Preamp (Stone)*§	Feb 32
Automobile	
Ignition Analyzer for Hobbyist or Pro (Scott)	May 35
Radio Servicing—See Servicing, Radio	
Soft-Tire Alarm	Jun 30
Start Your Car Fast*§ (Corres)	Feb 21; Apr 18
Autogen—1-Transistor Radio (Grace)*§	Mar 56
Automated Multiplex (Maddox)*	Apr 45
B	
Bandpass Crystal Tuner (Geisler)*	Jan 33
Base-Dip Oscillator (Sanford)*§	Jun 34
Battery(ies)	
Bell-button	Jun 49
Dry Cell, Inside (Kaye)	May 40
Dry, Which (Kaye)	Jun 46
Beam Plasma Tube Works Near Infrared (WN)	May 43
Bench Aids, Unusual (Comstock)	Feb 76
Bias, Fixed, in All Stages (Travis)*	Apr 24
C	
Cameras That Think (Stoner)	Jan 24
Capacitor(s)	
Checking (CL)	Apr 52
In-Circuit (TTO)	Jan 84
Electrolytic, High-Voltage Operation (Pat)	Jan 112
Electrolytic, Plug-in (TTO)	Apr 96
Solid, Contains No Electrolyte	Jun 51

KEY TO SYMBOLS AND ABBREVIATIONS

* Construction Articles	
† Section of full-length article	
§ Transistorized	
CI	Service Clinic
Corr	Correction
Corres	Correspondence
NB	News Briefs
NC	Noteworthy Circuits
Pat	New Patents
Tech	Techniques
TTO	Try This One
WN	What's New
Regular departments not itemized are New Books, New Literature, New Products, Technicians' News, What's Your EQ?	

Car—See Automobile	
Catholic Protection—Big Electronics (Beeler)	Mar 48
Ceramic Cartridges, Get Best from (Burstein)	Jun 28
Check Transistors with Scope (Smith)	May 32
Citizens Bend—See Radio, Citizens Band	
Coax Cable Tester, Simple (Lieberman)*	Jan 42
Coil Forms, Low-Loss (TTO)	May 95
Color TV—See Television, Color; Servicing, Television	
Computers—See Industrial Electronics	
Connectors, Insulating Lugs and (TTO)	Feb 94
Contact Load Multipliers (Ives)*§	Feb 40
(Corres)	Apr 20
Convert Recorder to Slow Speed (Queen)	Jun 70
Crystal Bandpass Tuner (Geisler)*	Jan 33
Current Sources, Unusual (Queen)*§	Mar 64
D	
Dc-to-Dc Supply, Novel (Fred)	May 46
Diode Rectifiers Last Longer, Make (Marriner)	May 62
Doing the TV Scramble (Kamen)	Mar 58
Dry Cell, Inside the (Kaye)	May 40
E	
Editorials (Written by Hugo Gernsback)	
After Computer, What?	Jun 23
Automated Electronic Newspaper	Mar 31
Electronic Revolution	Apr 23
Human Electronic Transmitters	Feb 23
Language Rectifiers	May 23
Newspaper, Automated Electronic	Mar 31
Television and Sound	Jan 23
Education(al)	
Blind Learn Electronics in Special School	Jun 27
Electronics Teaching Aids	Jun 52
Television	
Covers 90% of Population (NB)	May 14
Growth (NB)	Feb 12
In Action	Jan 34
MPATI Asks More Channels (NB)	Apr 14
Surgeons Trained by Microscope (NB)	Jan 6
Toys, New Scientific, Teach Kids to Think	Apr 31
Eight Transistors, Ten Watts of Hi-fi (D'Airo)*§	May 44
Electron Cloud Head for Tape Playback	Mar 41
ELECTRONIC(S)	
Blind Learn in Special School	Jun 27
Catholic Protection (Beeler)	Mar 48
Circuit, How to Scribble (Turner)	Jun 32
Computers—See Industrial Electronics	
Conductors Opaque? (Corres)	Jan 18; Mar 26
Data Storage (Pat)	Jun 99
Dc-to-Dc Supply, Novel (Fred)*	May 46
Electro-optical Amplifier (NB)	Jun 8
Encapsulator, Transparent	Jun 36
ESP, Governments Study (NB)	Jun 12
Expander, Volume (Pat)	Apr 99
Fiber Optics in Chinese Typesetter (NB)	Jan 10
Fuel Cell Burns Hydrocarbons (NB)	Mar 6
Fusing Electrical Equipment (TN)	Mar 99
Highlights of 1962 (NB)	Jan 16
Industrial—See Industrial Electronics	
Information Transmission, New Techniques	Mar 39
Speed	Mar 39
Infrared Communicator (WN)	Jan 39
Infrared Detector, Selective (Pat)	May 91
Jupiter Signals Due to Master Action (NB)	Jan 6
Lamps Devices for Making Light? (NB)	Feb 6
Laser—See Laser	
Light Meter, Sensitive (Conant)*	Apr 48
Lock, Electric Combination (NC)	Feb 97
Madistor (NB)	Mar 10
Medicine—See Medicine	
MHD Generator Uses Superconductive Materials (NB)	Apr 12
Music—See Audio	
Navigation Aid Is Pictorial Computer (NB)	Jan 6
Neon Baffle (NC)	Apr 101
Oscillator, Tunnel Diode (Pat)	Jun 99
Photomultiplier, Stabilized (Pat)	Mar 104
Power Supply	
Dc-to-Dc, Novel (Fred)	May 46
Dual (Pat)	May 92
Transistor-Safe (Bammel)*§	Jan 32
Print Reader Reads 20 Kinds of Type (NB)	Mar 18
Printed-Circuit Pin Connections (NB)	May 14
Publication on Phonograph Record	Apr 58
Radiation, Atomic, Vif Receiver Detects (NC)	Jun 97
Radio Telescope Protected from TVI (NB)	May 10
Range in Home (Shields)	Mar 37

ELECTRONICS (Continued)

Regulator, Flash-Tube (Pat)	Apr 99
Silicon Rectifier Adapter (TTO)	Feb 94
Solid-State Device Combines Tube and Transistor Features (NB)	Apr 12
Start Your Car Fast*§ (Corres)	Feb 21; Apr 18
Sun-Tracking Robot Furnace (Jaski)* (Corres)	May 16
Switching (van den Bosch)	Jan 60
Switching, Fast (Pat)	Jan 91
Teaching Aids	Jun 52
Telephone Carries 100 Conversations on Single Path (NB)	Feb 8
Telephone Repeaters (WN)	Jan 39
Temp-All (Stone)*§	Feb 45
Temperature Control, 2-Position (Pat)	Feb 116
Toys, New Scientific, Teach Kids to Think	Apr 31
Transients, Watch Out for (Leftwich)	Apr 28
Ultrasonic Waves Rotated by Magnetic Field (NB)	Mar 10
Vacuum Chambers, Open-Ended	Jun 76
Venus Lacks Magnetic Field? (NB)	Mar 18
Voltage Supply, Regulated Heater (NC)	Jan 109
Watch (Pat)	Jun 99
Waveforms Tell Story (Middletown)	Mar 53
F	
Fixed Bias in All Stages (Travis)*	Apr 24
FM	
Antenna Has High Gain and Quality (Churchill)*	Mar 50
Applications Frozen (NB)	Mar 6
Multiplex Stereo	
Adapter Aids (Williams)*§	Feb 28
Automated (Maddox)*	Apr 45
In Hi-fi Packages (Scott)	Apr 32
Multipath Distortion—A Threat?	Feb 42
One-Station (NB)	Jun 14
Stereo Generator, New Low-Cost (Mordwinkin)	Apr 60
Stereo the Easy Way (Leslie)	Jan 68
Tuner(s)	
Sensitivity, Inboard Preamp Boosts (Drenner)*	May 26
Tunnel Diode (Corres)	Mar 24
\$29.50 and Up, Up, Up (Feldman)	May 36
Frequency and Marker Chart (Dudley)	Mar 52
Fusing Electrical Equipment (TN)	Mar 99
G	
Garage Door, Receiver Opens (Phelps)*§	Jan 26
Corr	Apr 34
Good Little Indian, the Mohican (Frye)	Apr 36
H	
Handling Color TV Customer (McCarty)	May 47
Hearing Aid in Aspirin Box (de la Roza)*§	Jan 37
Hi-fi (see also Audio—Stereo—High Fidelity)	
Bottom, Improving (Marshall)	May 49
Enclosure from Old TV (West)	Jan 45
Highlights, Electronic, of 1962 (NB)	Jan 16
Holes (Darr)	Apr 40
Hum, Puzzled About? (Prasil)	Apr 58
I	
Ignition Analyzer for Hobbyist or Pro (Scott)	May 35
Imagination Plus (Brayton)	Feb 24
Improve TV Sound and Quality (Marcek)	Apr 46
Improving the Hi-fi Bottom (Marshall)	May 49
Improving Single-ended Outputs (Mooney)	Mar 45
Inboard Preamp Boosts FM Tuner Sensitivity (Drenner)*	May 26
Industrial Electronics	
Catholic Protection—Big Electronics (Beeler)	Mar 48
Coax Cable Tester, Simple (Lieberman)*	Jan 42
Computer(s)	
Data Transmission Speeded	Mar 39
Frog's Eye Electronic (NB)	Jun 6
Law from? (NB)	May 8
Pictorial, Navigation Aid (NB)	Jan 6
Reads 20 Kinds of Type (NB)	Mar 18
Skip-puter? (NB)	Feb 12
Contact Load Multipliers (Ive)*§	Feb 40
Corres	Apr 20
Diode Rectifiers Last Longer, Make (Marriner)	May 62
Infrared Communicator (WN)	Jan 39
Intercom, Transformerless (Schotz)*§	Feb 74
Low-Approach System (WN)	May 43
Range, Electronic, in Home (Shields)	Mar 37
Technician Shortage Worsens	Feb 66
Corres	Apr 17
TV, Closed-Circuit, Simpler	Jan 62
TV Station All-Robot (NB)	Jun 6
Videocan Uses TV Techniques (NB)	May 6
Waffle-Iron Memory Device (WN)	May 43
What's Different (Darling)	Jun 48
X-ray Vidicon (NB)	Apr 8
Inside the Dry Cell (Kaye)	May 40
Intercom, 7-Station, Uses One Master (Hochberg)*§ (Corres)	Mar 24
Intercom, Transformerless (Schotz)*§	Feb 74
Inventors of Radio (Bartlett)	
Maxwell (Corres)	Jan 18; Mar 26
Tesla, Nikola	Apr 35

J	Just Plain Flash (Henry)*	May 24	Power Supply	May 46	RADIO (Continued)	Apr 100
K	Kits, Miniature (NB)	Jan 8	Dc-to-Dc, Novel (Fred)	May 92	Switch, Receiver Disabling (NC)	Mar 104
	Kits, New Scientific Toys Teach Kids to Think	Apr 31	Dual (Pat)	Jan 32	Transmitter, Self-Powered (Pat)	Jan 33
L	Lab's Whole Job Service Research	Feb 39	Pushbuttons Add Ohms or Mf's (Fred)	Mar 72	Tuner, Bandpass Crystal (Geisler)*	Apr 14
	Laser	Mar 57	Put Maximum Power Into CB Antenna	May 30	Voice of America Doubles Power (NB)	Jan 6
	Crossbow, Space-Age	Jan 28	(Stiebel)	Apr 58	WWVB and WWVL Improved (NB)	Mar 37
	Here Comes the (McQuay)	Jan 8	Puzzled-About Hum? (Prasil)		Range, Electronic in Home (Shields)	May 29
	Solar-powered (NB)	Feb 16			Reshoeing a Picture Tube (Darr)	Mar 101
	Solid-State, on Sale (NB)	Apr 14	R		Resistors, Precision (TTO)	
	TV Transmission, First (NB)	Apr 48	Radar			
	Light Meter, Sensitive (Conant)*	Feb 70	Antenna, Cloverleaf (WN)	Jan 39	S	
	Little Dipper (Queen)*§	Jun 24	Doppler Navigators (NB)	Jan 14	Satellite(s)	Jun 6
	Log Periodic V (Finkel)		Doppler, Underwater, Guides Surface	Feb 16	Animals May Be Tracked by (NB)	Feb 8
M	Madistor (NB)	Mar 10	Vessels (NB)	May 28	Telstar	Mar 6
	Maser, Jupiter Signals Due to Action (NB)	Jan 6	RADIO	Mar 50	Command Circuit Out (NB)	Apr 6
Medicine	Deafness	Apr 29	Amplifier, No Service Needed	Apr 49	Remote Repair (NB)	Mar 6
	Electronic Ear Brings Sound to Deaf	Apr 37	Antenna, FM, Has High Gain and Quality	Mar 35	Van Allen Belt, Reports on (NB)	Apr 6
	Hearing Aid in Aspirin Box (de la Roza)*§	May 8	(Churchill)*	May 30	Tiros Makes TV Picture Of Earth's Cloud	Apr 6
	Understanding Aid (NB)	Jan 113	Audio Output Circuit, Complementary	Apr 49	Cover (NB)	Jun 32
	Generator, Negative-Ion (Pat)	Jan 6	Symmetry (Roy)	Mar 56	Scribble Circuit, How to (Turner)	Jun 32
	Surgeons Trained by TV and Microscope	Jan 46	Autogen, 1-Transistor (Grace)*§	May 71	Selective Calling Improves CB Operation	Mar 40
	(NB)	Mar 26	Bfo for SSB (NC)	Mar 35	(Scott)	
	Mixed Waveforms and Scope (Middleton)	Mar 26	Broadcasts, Setting Up for Remote (Darr)	Jun 50	Semiconductor(s)—See also Transistor	
	Corres	Mar 47	Citizens Band	May 30	Germanium Diode Has Two Whiskers (NB)	May 8
	Mixer-Preamp, Multipurpose 2-Channel	Apr 36	Accessories Improve Operation (Scott)	Feb 6	Madistor (NB)	Mar 10
	(Schotz)*§	Feb 42	Antenna, Put Maximum Power Into	Jan 16	Terms, Guide to (sylvania)	Jan 76
	Mohican, Good Little Indian (Frye)	Mar 46	(Stiebel)	Feb 6		
	Multipath Distortion—Threat to Stereo?	Mar 46	FCC Rules Proposed (NB)	Jan 26	SERVICING —See also specific subject;	
	Multiplex—See FM, Multiplex Stereo	Mar 46	FCC Takes§ Action (NB)	Apr 34	Test Instruments	
	Multipurpose 2-Channel Mixer-Preamp	Mar 46	Receiver Opens Garage Door (Phelps)*§	Mar 40	Audio	
	(Schotz)*§	Mar 46	Corr	Jun 14	Cables, Using Shielded (Darr)	Jun 62
Music —See Audio			Selective Calling Improves Operation	Jan 84	Organ Tuning by Phone (TTO)	Jun 94
			(Scott)	Jan 84	Organ Volume Control (Hammond) (CI)	Jun 59
N	No Service Need on This Amplifier	May 28	Servicing—See Servicing, Radio	Apr 100	Phono Slippage (TN)	Jun 88
O	Oscamp, Ac Bridge (Queen)*§	Apr 50	Command Pack, 37-lb (NB)	Jan 39	Record Changer Work Stand (TTO)	Apr 98
P	Panel Meters Need Home (Carlson)	Apr 51	Earpieces, Soft Tips for (TTO)	Jan 26	Recorder Rewind (Continental 400) (TN)	Jun 88
Photography	Cameras That Think (Stoner)	Jan 24	FM—See FM	Apr 26	Rf Pickup (CI)	May 52
	Flash, Just Plain (Henry)*	May 24	Gain Multiplier, Rf Q (NC)	Jan 39	Speaker Holes, Odd-Shaped (TTO)	Apr 96
	Light Meter Sensitive (Conant)*	Apr 48	Helmet and Hand-held Transmitter (WN)	Mar 26	Stereo Phono (Philco H-1716, -1814, -1816)	Jun 89
	Nanosecond, with New Image Tube (NB)	Apr 6	Inventors of (Bartlett)	Apr 35	(TN)	Mar 99
Potentiometers	Calibrated (Carlson)	May 63	Maxwell (Corres)	Jan 18; Mar 25	Tape Recorders (VM) (TN)	Mar 99
	Helical (TTO)	Feb 94	Tesla, Nikola	Apr 35	Battery-Polarity Reminders (TTO)	Apr 98
	Standoffs Mount on (TTO)	Mar 102	Jupiter Signals Due to Maser Action (NB)	Jan 6	Bench Aids, Unusal (Comstock)	Feb 76
			Mobile, Wants TV Channels (NB)	Mar 20	Cable Standoffs (TTO)	Jan 86
			Mohican, Good Little Indian (Frye)	Apr 36	Capacitors (CI)	Apr 52
			Power Supply, Transistor-Safe (Bammel)*§	Jan 32	Cleaning Aid for Equipment	Mar 55
			Remote Broadcasts, Setting Up for (Darr)	Mar 35	Cord Holder (TTO)	Mar 103
			Remote-Control Transmitter, Tunnel-Diode	Jun 37	Holes (Darr)	Apr 40
			(Cleary and Gottlieb)*§		Hot-Chassis Protection (TTO)	Mar 103
			Servicing—See Servicing, Radio		Industrial	
			Short-wave	Jan 14	Counters (PIC) (TN)	Feb 99
			Dx Affected by Sunspots (NB)	Apr 36	Diode Rectifiers Last Longer, Make	May 62
			Mohican, Good Little Indian (Frye)	Jan 31	(Marriner)	Jan 74
			Propagation Forecast (Leinwoil)	May 78	Emergency Repair (Ziemke)	May 85
			Single Sideband, Bfo for (NC)	Apr 99	Motor Controls, Thyatron (TN)	May 85
			Sound-Powered (Pat)		Intercom Amplifier (E1DB-10B) (TN)	May 85

TV-RADIO Servicemen or Beginners..

2 WEEKS FREE TRIAL!

Just Send name for **Coyne's** Seven Volume **Job-Training Library!**



The First Practical TV-RADIO-ELECTRONICS Shop Library!

Answers ALL Servicing Problems QUICKLY...
Makes You Worth More On The Job!

Put money-making, time-saving TV-RADIO-ELECTRONICS know-how at your fingertips—examine Coyne's all-new 7-Volume TV-RADIO-ELECTRONICS Reference Set for TWO WEEKS at our expense! Shows you the way to easier TV-Radio repair—time saving, practical working knowledge that helps you get the BIG money! How to install, service and align ALL radio and TV sets, even color-TV, UHF, FM and transistorized equipment. New photo-instruction shows you what makes equipment "tick." No complicated math or theory—just practical facts you can put to use immediately. Over 3,000 pages; 1200 diagrams; 10,000 facts! Ready to use in shop or home.

SEND NO MONEY! Just mail coupon for 7-Volume TV-Radio Set on FREE BOOK below. If you keep the set, pay only \$3 after TWO WEEKS and \$3 per month until \$27.25 plus postage is paid. Cash price only \$24.95. Or return set at our expense in TWO WEEKS and owe nothing. Offer limited, so act NOW!

"LEARNED MORE FROM THEM THAN FROM 5 YEARS WORK!"

"Learned more from your first two volumes than from 5 years work."
—Guy Bliss, New York
"Swell set for either the serviceman or the beginner. Every service bench should have one."
—Melvin Masbruch, Iowa.

KEEP FREE DIAGRAM BOOK EVEN IF YOU RETURN THE SET

We'll send you this big book. "150 Radio-Television Picture Patterns and Diagrams Explained" ABSOLUTELY FREE just for examining 7-Volume Shop Library on TWO WEEKS FREE TRIAL! Shows how to cut servicing time by reading picture-patterns, plus schematic diagrams for many TV and radio sets. Yours to keep FREE even if you return the 7-Volume Set! Mail coupon TODAY!



Like Having An Electronics Expert Right At Your Side!

ALL 7 BOOKS HAVE WASHABLE, VINYL CLOTH COVERS

- VOL. 1—EVERYTHING ON TV-RADIO PRINCIPLES!** 300 pages of practical explanations; hundreds of illustrations.
- VOL. 2—EVERYTHING ON TV-RADIO-FM RECEIVERS!** 403 pages; fully illustrated.
- VOL. 3—EVERYTHING ON TV-RADIO CIRCUITS!** 336 pages; hundreds of pictures and circuits.
- VOL. 4—EVERYTHING ON SERVICING INSTRUMENTS!** How they work, how to use them. 368 pages; illustrated.
- VOL. 5—EVERYTHING ON TV TROUBLESHOOTING!** Covers all types of sets, 437 pages; illustrations, diagrams.
- VOL. 6—TV CYCLOPEDIA!** Quick and concise answers to TV problems in alphabetical order, including UHF, Color TV and Transistors; 868 pages.
- VOL. 7—TRANSISTOR CIRCUIT HANDBOOK!** Practical Reference Transistor Applications; over 200 Circuit Diagrams; 472 pages.

FREE BOOK—FREE TRIAL COUPON!

COYNE SCHOOL PUBLICATIONS, Dept. 63-RE
1455 W. Congress Parkway, Chicago 7, Illinois

Yes! Send me COYNE'S 7-Volume Applied Practical TV-RADIO-ELECTRONICS Set for TWO WEEKS FREE TRIAL. Include "Patterns & Diagrams" book FREE!

Name _____ Age _____
Address _____

City _____ Zone _____ State _____

Check here if you are sending \$24.95 in full payment. Same TWO WEEK Money-Back Guarantee applies.

Coyne SCHOOL PUBLICATIONS
Dept. 63-RE, 1455 W. Congress Parkway, Chicago 7, Ill.

SERVICING (Continued)

Leakage Testing (CI)	Apr 52
Plug Handle, Unbreakable (TTO)	Jun 93
Potentiometers, Calibrated (Carlson)	May 63
Potentiometers, Standoffs Mount on (TTO)	Mar 102
Printed Circuits, Service Aids (TTO)	May 93
Radio	
Auto	
OZ4 Replacement (TN)	Mar 99
Imagination Plus (Brayton)	Feb 24
Battery Life Short (RCA 6-BX-5) (TN)	Jun 86
Battery Life Test Circuit (Motorola) (TN)	Jun 86
CB	
Repairs You Can Make Without License (Darr)	Feb 34
Tube Inventory (Kyle)	May 60
Clutch Assembly (Metz 604) (TN)	Jan 107
Converter Replacement (RCA 7-BT-9, -10) (TN)	Jun 89
I.f. Amplifier Replacement (Westinghouse H148) (TN)	May 84
Intermittent (Emerson 888) (TN) Apr 95;	
(Motorola 56CD) (TN)	Feb 99
Rf Pickup (CI)	May 52
Short-wave, Kill on Old Sets? (TTO)	Apr 97
Squeech Troubles, Unusual (Wiegert)	Apr 27
Transistor, Disturbance (TN)	Jun 88
Transistor, Motorboating (Emerson 844) (TN)	Jun 89
Scope	
Focus Control Out (Waterman 3-in.) (TN)	Jun 86
Intermittent Vertical Amplifier (Waterman 3-in.) (TN)	Jun 86
Linear, Keep Your (Darragh)	Apr 64
Silicon Rectifier in Fuse Clip (TTO)	Apr 97
Silicon Rectifier, Series-Connected (TN)	Mar 99
Socket Storage (TTO)	Mar 103
Switch Replacing Irreplaceable	Apr 39
Technician Shortage Worsens	Feb 66
Corres	Apr 17
Television	
Agc (G-E 14T009) (CI) Apr 56; (RCA KCS-136) (CI)	May 56
Antenna Rotor Pin, Emergency (TN)	Mar 100
Audio Reflex Circuit (Admiral 17X3) (CI)	May 56
Boost Out (Admiral 21D1) (CI)	Apr 54
Brightness Fixed (Raytheon M1750) (CI)	Mar 63
Color	
Customer, Handling (McCarty)	May 47
Failure, Unsuspected Cause (Middleton)	Feb 50
Fringing (RCA 21CT660U) (CI)	May 56
Worms in Picture (Zenith 29CJ120) (CI)	May 55
Conversion (CI) Mar 60; (24AJP4) (CI)	Jun 58
Diagnosis, Impartiality In (CI) Feb 56; (CI)	June 53
Flyback Failures (CI)	Apr 54
Flyback Replacement (Bendix TM-21CS) (CI) Feb 58; (Truetone 2D2047) (CI)	May 52
Frequency and Marker Chart (Dudley)	Mar 52
Heater Trouble (Admiral 15C1) (CI)	Mar 60
High Voltage Out (Admiral 21D1) (CI)	Apr 54
Horizontal Hold (Flestone) (CI) May 52;	
(Stewart-Warner 9126) (CI)	Feb 56
Horizontal Range Lacking (Stewart-Warner 9126) (CI)	Jan 56
Interference (TN) May 84; RCA 21CS7815—	
CTC5) (TN)	Apr 95
Mirror Setup for Viewing (TTO)	Jan 84
Oscillation, Spurious (Philco E-670/E-676) (TN)	Apr 94
Picture	
Displaced (Crosley 473) (TN)	Apr 94
Flicker (CI)	Jun 58
Focus and Brightness (RCA KCS-82) (TN)	May 85
Half a (RCA KCS-104A) (CI)	May 58
Intermittent Ripples (G-E 24C101) (TN)	Jan 106
Narrow (Motorola 12T1) (CI) Mar 63; (RCA KCS-47) (CI)	Feb 58
Pulling (RCA KCS-72) (CI)	Jan 56
Retrace Lines (Philco 52T1802) (CI)	Feb 59
Size vs Raster Size (CI)	Jun 53
Smear (Motorola TS-544) (TN)	Jun 86
Sound and, Intermittent (Motorola VTS505) (TN)	Apr 95
Split (Zenith 16V23) (CI)	Mar 63
Tube	
Needed (Majestic) (CI)	Jun 58
Faceplate, Polish Yourself (Parker)	May 42
Jig (TTO)	Feb 95
Life Short (RCA KCS-96B) (CI)	Apr 56
Replacement (CI)	Mar 60
Reshoeing (Darr)	May 29
Shorts, Socket Adapter Fixes (TTO)	May 94
Shrinking and Blooming (Philco F3041) (TN)	Feb 99
Width (TN) Feb 104; (TN)	Jun 89
Needed (Majestic) (CI)	Jun 58
Purity Checker (TN)	Apr 95
Quality, Improve Sound and (Marcek)	Apr 46
Rectifier Replacement (5MK9) (TN)	Apr 94
Rectifier Replacement (Silicon for Selenium) (CI)	Feb 59
Research, Lab's Whole Job	Feb 39
Selenium Rectifier Replacement (CI)	Feb 59
Scope, Mixed Waveforms and (Middleton) Corres	Jan 46
Mar 26	
Sound	
Bad (CI)	Feb 58
Improve Quality and (Marcek)	Apr 46
Intermittent (Westinghouse H-637T14) (CI)	May 55
Picture and, Intermittent (Motorola VTS505) (TN)	Apr 95
Picture and, Out (TN) Jan 106; Raytheon C1401, etc. (TN)	Apr 94
Squeal, No Raster (Philco E2004F) (TN)	Jan 107
Sync Control (Philco 11H25U) (TN)	May 84

SERVICING Television (Continued)

Sync Poor (RCA KCS-120) (TN) Jan 106; (RCA 14S7052-KCS102B) (TN)	Jan 107
Tuner Channels Out (Muntz/Standard Coll) (TN)	Jun 88
Tuner Replacement (G-E 17C105) (CI) Mar 63;	
(Raytheon 20AV21) (CI)	May 56
Vertical	
Growing (Sylvania 537-3) (CI)	Jan 56
Instability (CI)	Feb 56
Roll (Motorola 21T57) (CI) Apr 54;	
(Muntz 721TS) (CI)	Apr 56
Sweep Blips (Philco 22B4400) (CI)	Feb 62
Video Short (Tele-King K73) (CI)	Jan 55
Video Washout (Admiral 20A7) (CI)	Apr 56
Waveforms (CI)	Jan 52
Mixed, and Scope (Middleton) Corres	Jan 46
Mar 26	
Tell Story (Middleton)	Mar 53
Timing Repair Work with Stop Watch (TTO)	Feb 95
Tool Handles, Better Grip (TTO)	Jan 86
Transients, Watch Out for (Leftwich)	Apr 28
Tube Inventory (TTO)	Apr 96
Tubes, Easy In, Easy Out (TTO)	Jun 93
Warranty Expiration Notification (TN)	Feb 99
Setting Up for Remote Broadcasts (Darr)	Mar 35
Signal Injector for Vtvm (Reed)*§	Apr 30
Silent TV Listening (Hamilton)*§	Jun 42
Soldering	
Gun, Midget Tip (TTO)	Mar 102
Meters Nearby (TN)	Mar 100
Pencil-Iron Holder (TTO)	Apr 97
Pot, Miniature (TTO)	Jun 93
Simplified (Stillwell)	Jun 31
Third Hand for (TTO)	Feb 94
Solid Sync for Scope (McLeod)	Feb 78
Space—See also Satellites	
Jupiter Signal Due to Maser Action (NB)	Jan 6
Sunspots Affect Dx (NB)	Jan 14
Van Allen Belt, Teletar Reports on (NB)	Apr 6
Venus Lacks Magnetic Field? (NB)	Mar 18
Spiker (Frantz)*	May 27
Squelch Troubles, Unusual (Wiegert)	Apr 27
Stereo—See Audio—Stereo—High Fidelity; FM Switching	
Electronic (van den Bosch)	Jan 60
Fast (Pat)	May 91
Trans-Switch (Stone)*§	Jun 44
Telephone	
Amplifier Needs No Service	May 28
Repeater (WN)	Jan 39
Single Path, 100 Conversations (NB)	Feb 8
TELEVISION	
Antennas, Rabbit-Ear, Rubber Bumpers for (TTO)	Feb 94
Audio Takeoff, Unusual (Roy)	May 67
Camera Beats Human Eye (NB)	May 10
Color	
Close-Circuit, Simpler	Jan 62
Customer, Handling (McCarty)	May 47
Goink Up (NB)	Jun 12
Theater, Large-Screen (NB)	May 6
Tube, 90°, Delayed (NB)	Feb 18
Tube, New? (NB)	Jun 6
Commercial Killer Modification (NC)	Feb 98
Commercials Loud (NB)	Feb 12
Educational	
Covers 90% of Population (NB)	May 14
Growth (NB)	Feb 12
In Action	Jan 34
MPATI Asks More Channels (NB)	Apr 14
Surgeons Trained by Microscope and (NB)	Jan 6
Frequency and Marker Chart (Dudley)	Mar 52
Hi-Fi Enclosure from Old (West)	Jan 45
Laser Transmission, First (NB)	Apr 14
Listening, Silent (Hamilton)*§	Jun 42
Ownership, Foreign Passes US (NB)	Jun 16
Pay, Denver to Start (NB)	Mar 10
Pay—Doing the Scramble (Kamen)	Mar 58
Quality and Sound, Improve (Marcek)	Apr 46
Rental, British	Jan 49
Replacements Increase (NB)	Feb 10
Scramble, Doing the (Kamen)	Mar 58
Sound, High-Fidelity (Gernsback) (Corr)	Feb 62
More On	Mar 47
Station All-Robot (NB)	Jun 6
Tape Recorders, Low-Priced (NB)	Feb 6
Teleyeglasses (Fiction) (Fips)	Apr 43
Tube Layouts (Steckler) (Airline) Feb 37;	
(Truetone)	Jan 35
Typesetter Uses Fiber Optics and (NB) Uh†	Jan 10
How to Handle (Cantor)	Mar 42
Rules (NB)	Feb 10
Within 10% of Vhf	May 42
Videocan Computer (NB)	May 6
Teleyeglasses (Fiction) (Fips)	Apr 43
Temp-All (Stone)*§	Feb 45
Ten Watts of Hi-fi, Eight Transistors (D'Airol)*§	May 44
TEST INSTRUMENTS—See also Specific Subject; Servicing	
Ac Bridge, Oscamp (Queen)*§	Apr 50
Amplifier Boosts Vm Sensitivity (Fasal)*§	Mar 32
Attenuator, Hum (NC)	May 69
Base-Dip Oscillator (Sanford)*§	Jun 34
Capacitance Measurement (NC)	Jun 97
Capacitor Testing, In-Circuit (TTO)	Jan 84
Coax and Transistor Tester (Eico 680)†	Mar 68
Coax Cable Tester, Simple (Lieberman)*	Jan 42
Continuity Checker (El-Dhuwaib)*§	May 48
Corner Case for (TTO)	May 93
Dipmeter, Tunnel (Heathkit HM-10A)†	May 66

TEST INSTRUMENTS (Continued)

Dipper, Little (Queen)*§	Feb 70
Dummy Load (Cantenna)†	Jun 66
Generator, Clamping Device, Improved (Pat)	May 92
Generator, Low-Cost FM Stereo (Mordwinkin)	Apr 60
Ignition Analyzer for Hobbyist or Pro (Scott)	May 35
Meter(s)	
Panel, Need Home (Carlson)	Apr 51
Protection (Pat)	Jan 112
Saver Ends Burnouts (Karp)*§ (Corres)	Jan 21
Soldering Near (TN)	Mar 100
SWR (Knight-Kit P-2)†	Feb 66
Multimeter, DC Transistor (Motorola S1052B)†	Jun 66
Ohms or Mf's, Pushbuttons Add (Fred)	Mar 72
Potentiometer, Helical (TTO)	Feb 94
Power Rectifier Test Substitute (Remel)	Apr 34
Pushbuttons Add Ohms or Mf's (Fred)	Mar 72
Relay Coil Tester (Pat)	Feb 116
Resonance Indicator (NC)	Mar 105
Scope	
Brightness Increased (NC)	Mar 107
Linear, Keep Yours (Darragh)	Apr 64
Mixed Waveforms and (Middleton) Corres	Jan 46
Mar 26	
Monitor (Heath HO-10)†	Feb 68
Solid Sync for (McLeod)*	Feb 78
Switching, Electronic (van den Bosch)	Jan 60
Transistors, Checked with (Smith)	May 32
Trans-Switch (Stone)*§	Jan 44
Use Your (Darr) (Corr)	Feb 21
Wide-Band 3-Inch (Sencore PS120)†	May 64
Shorted-Turn Indicator (Metro-Tel)†	Jan 66
Signal	
Injector for Vtvm (Reed)*§	Apr 30
Tracer, Tunable Af (Turner)*§ (Corres)	May 16
Tracer, Tuned (Conar 230)†	Jan 62
Spiker (Frantz)*	May 27
Sweep Circuit Analyzer (Sencore SS117)†	Mar 67
Switching, Electronic (van den Bosch)	Jan 60
SWR Meter (Knight-Kit P-2)†	Feb 66
Tachometer, Calibration Error (TN)	Mar 100
Tracer, Diode Curve (NC)	May 70
Transistors	
Check with Your Scope (Smith) and Circuit Tester (Eico 680)†	May 32
Vtvm Tests (Horowitz)*	Mar 68
Jan 40	
Transmitter Tester (Pat)	Feb 116
Tunnel Dipper (Heathkit HM-1 10A)†	May 66
Voltage Supply, Variable Ac (NC)	Mar 106
Voltmeter, Audio, Doubles as Preamp (Stone)*§	Feb 32
Vom	
Peak Voltage Indicator (NC)	Jan 110
Sensitivity, Amplifier Boosts (Fasal)*§	Mar 32
Vtvm	
Jacks (TTO)	Mar 101
Peak Voltage Indicator (NC)	Jan 110
Signal Injector (Reed)*§	Apr 30
Transistors, Test With (Horowitz)*	Jan 40
0-2-Volt Range (TTO)	May 94
Transients, Watch Out for (Leftwich)	Apr 28
Transistor(s)	
Identifier (NC)	Mar 105
Neon Lamp Protects (NC)	Feb 97
and Tube Features Combined in Solid-State Device (NB)	Apr 12
Transistorized—See specific subject (transistorization indicated by § after title of construction article)	
Trans-Switch (Stone)*§	Jun 44
Try Fixed Bias in All Stages (Travis)*	Apr 24
Tube(s)	
Beam Plasma, Works Near Infrared (WN)	May 43
Color 90°, Delayed (NB)	Feb 18
Color, New? (NB)	Jun 6
Sensitive (Pat)	Jan 112
Image, Nanosecond Photography with (NB)	Apr 6
Solid-State Device Combines Features of Transistor and (NB)	Apr 12
Vidicon, X-ray (NB)	Apr 8
Tuner	
Bandpass, Crystal (Geisler)*	Jan 33
FM, Sensitivity, Inboard Preamp Boosts (Drenner)*	May 26
Servicing—See Servicing	
Tunnel Diode† (Corres)	Mar 24
\$29.50 and Up, Up, Up, Up (Feldman)	May 36
Tunnel Diode Remote Control Transmitter (Cleary and Gottlieb)*§	Jun 37
U	
Uhf	
TV, How to Handle (Cantor)	Mar 42
Rules (NB)	Feb 10
Within 10% of Vhf	May 42
Ultrasonic Waves Rotated by Magnetic Field (NB)	Mar 10
Unsuspected Cause of TV Color Failure (Middleton)	Feb 50
Unusual Current Sources (Queen)*§	Mar 64
Unusual Squelch Troubles (Wiegert)	Apr 27
W	
Watch Out for Transients (Leftwich)	Apr 28
Waveforms, Mixed, and Scope (Middleton) Corres	Jan 46
Jan 26	
Waveforms Tell Story (Middleton)	Mar 53
What's Different About Industrial Electronics (Darling)	Jun 48
What's Old (Barrett)	Feb 31
Which Dry Battery (Kaye)	Jun 46

the HIDDEN 600*

PRESENT 
5 WORLD FAMOUS PERFORMERS **5**

*The "Hidden 600" are Sprague's behind-the-scenes staff of 600 experienced researchers who man the largest research organization in the electronic component industry and who back up the efforts of some 8,500 Sprague employees in 26 plants.

DIFILM® BLACK BEAUTY® MOLDED TUBULAR CAPACITORS



The world's most humidity-resistant molded capacitors. Dual dielectric—polyester film and special capacitor tissue—combines best features of both. Exclusive HCX® solid impregnant produces rock-hard section—nothing to leak, or drip. Tough case of non-flammable phenolic—cannot be damaged in handling.

DIFILM ORANGE DROP® DIPPED TUBULAR CAPACITORS

Especially made for exact, original replacement of radial-lead tubulars. Ideally suited for printed wiring boards. Dual dielectric combines the best features of both polyester film and special capacitor tissue. Exclusive HCX® solid impregnant—no oil to leak, no wax to drip. Double dipped in bright orange epoxy resin to beat heat and humidity.



TWIST-LOK® ELECTROLYTIC CAPACITORS

The most dependable capacitors of their type. Built to "take it" under torrid 185°F (85°C) temperatures—in crowded TV chassis, sizzling auto radios, portable and ac-dc table radios, radio-phonos combinations, etc. Hermetically sealed in aluminum cases for exceptionally long life. Withstand high surge voltages. Ideal for high ripple selenium rectifier circuits.

ATOM®

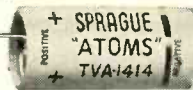

ELECTROLYTIC CAPACITORS

The smallest dependable electrolytics designed for 85°C operation in voltages to 450 WVDC. Small enough to fit anywhere, work anywhere. Low leakage and long shelf life. Will withstand high temperatures, high ripple currents, high surge voltages. Metal case construction with Kraftboard insulating sleeve.

GERA-MITE® CERAMIC CAPACITORS

Tiny, tough, dependable in practically every application. Low self-inductance of silvered flat-plate design gives improved by-pass action in TV r-f circuits. Higher self-resonant frequency than tubular ceramics or micas. Tough moisture-proof coating. Designed for 85°C operation.



NOW APPEARING DAILY AT YOUR FAVORITE SPRAGUE DISTRIBUTOR!

For a permanent reference to this world-renowned galaxy of star performers, ask your Distributor for a copy of Sprague's handy Hanging Wall Catalog C-457, or write Sprague Products Company, 81 Marshall Street, North Adams, Massachusetts.

HOW can you prove you've heard hard-to-receive short wave stations?

This question, and many others about tape quality, tape use, and tape recording for fun, education, and profit, are answered in Tarzian Tape's new booklet, "Lower the Cost of Fun With Tape Recording."

It's free when you mail the coupon below.



Sarkes Tarzian, Inc.
Dept. RE-3
Magnetic Tape Division
East Hillside Drive
Bloomington, Indiana

Please send a free copy of "Lower the Cost of Fun With Tape Recording" to:

Name _____

Address _____

City _____ State _____

I Have Have Not used Tarzian Tape
I Own Plan to Buy A Tape Recorder
I Buy Blank Recording Tape From:

Name _____

Address _____

He Does Does Not Stock Tarzian Tape

Open-ended vacuum chamber

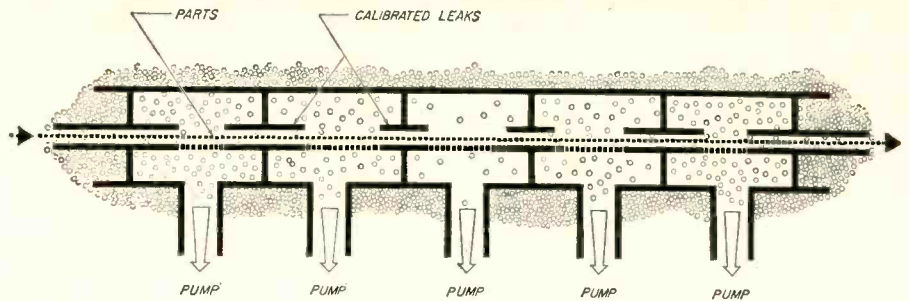

A high simplified illustration of how the open-ended continuous-vacuum machine works.

AN ENDLESS CONVEYOR THAT TAKES parts from open air through a vacuum chamber and back to the atmosphere again from high-level vacuum was demonstrated by Western Electric Co. at its Engineering Research Center, Princeton, N. J. The chamber was used to sputter thin films of tantalum for making thin film integrated circuits.

The vacuum chamber uses a series of locks (chambers of increasing vacuum). A certain amount of air enters through each lock, but pumps remove it faster than it leaks in. Thus each chamber is at a higher vacuum until, at the central chamber, the correct vacuum for the sputtering process is reached. The highest-vacuum chamber contains some gas—a very small amount of argon. A potential between 500 and 5,000 volts is maintained between the object to be sputtered and a sheet of tan-

talum. Argon atoms striking the tantalum knock off tantalum ions, which are deposited as pure tantalum metal in a very thin film on ceramic or glass blanks. The film is etched away to form a complete circuit. By coating portions of the circuit with a resist, and introducing a small amount of nitrogen into the chamber, the exposed tantalum becomes tantalum nitride, which has a high resistance. Thus the tantalum may be both a conductor or a resistor. It may also be treated with gas to form an excellent dielectric, after which another layer of metal can be deposited on top of it to form capacitor plates. Thus the same layer of tantalum may be a conductor, resistor or a portion of a capacitor.

The new continuous process machine is expected to produce large quantity lots of miniature circuits at a much lower cost at present.

WHAT'S YOUR EQ?

These are the answers.
Puzzles are on page 43.

Doubling in Capacitors

Nothing much. Removing C1 changes the full-wave doubler to a modified half-wave doubler as shown below.

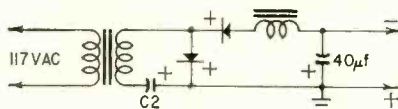

Ripple would be at 60 cycles instead of 120, and regulation would be poorer. However, since there is virtually no load, output voltage would not change.

Voltmeter Puzzle

Two Wheatstone bridges are connected in parallel. To balance the bridges, R1 must equal the internal resistance of voltmeter A and R2 must equal the internal resistance of voltmeter E. The zero reading on voltmeter

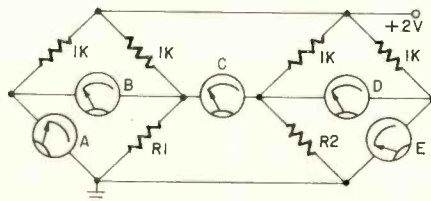

ters B, C and D shows that the bridges are balanced. Therefore, the value of 1,000 ohms for R1 shows that the internal resistance of voltmeter A is 1,000 ohms. Also, a value of 1,000 ohms for R2 shows the internal resistance of voltmeter E to be 1,000 ohms. When the internal resistance of voltmeter A and voltmeter E is known, the voltage drop across the meters can be easily calculated. The reading of each voltmeter is 1 volt, equal to the voltage across the meter.

How Many Diodes?

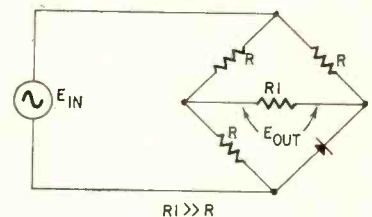

Only one diode is needed, in a quarter-bridge circuit as shown. This circuit, while not efficient, is sometimes used as an instrument rectifier (Conant Labs). For the given conditions, the output voltage is $E_{out} = \frac{1}{2} E_{in}$.

NOW EVERYONE CAN QUICKLY Set up and Service Color TV



New! **B&K** Model 850 **COLOR GENERATOR**

*Most Complete, Most Versatile, Portable Instrument for Use in the Home and in the Shop
Makes Color TV Set-up and Service Easier, Faster than ever!*

Now every service technician can be ready to set-up and service color TV with amazing new ease and speed! New advanced design simplifies the entire operation, saves time and work in every installation. Eliminates difficult steps in digging into the color TV set. Gives you new confidence in handling color.

Produces Patterns, Burst, and Colors Individually

—Provides dot pattern, crosshatch, vertical lines, horizontal lines, burst signal, and individual colors—one at a time—on the TV color set—for fastest, easiest check. Unique window-viewer on front of the instrument panel shows you each pattern as it should be—gives you an exclusive display standard to use as a sure guide for quick, visual comparison.

Provides Accurate, Individual Color Display—Produces Green, Cyan, Blue, B—Y, Q, Magenta, R—Y, Red, I, Yellow, and Burst—one at a time. All colors are crystal-controlled and are produced by a precision delay-line for maximum accuracy. Each color is individually switch-selected—no chance of error.

Provides Accurate NTSC-Type Signal—Color phase angles are maintained in accordance with NTSC specifications.

Makes Convergence and Linearity Adjustments Easy—Highly stable crystal-controlled system with

vertical and horizontal sync pulses, assures the ultimate in line and dot stability.

Simplifies Demodulator Alignment—The type of color display produced by this instrument provides the ultimate in simplicity for precise demodulator alignment.

Provides Automatic Deconvergence—Eliminates the necessity for continual static convergence adjustments. The instrument automatically deconverges a white into a color dot trio without digging into the color set to mis-adjust the convergence magnets. It also deconverges a white horizontal or vertical line into red, green and blue parallel lines. This greatly simplifies dynamic convergence adjustments.

Provides Exclusive Color Gun Killer—Front-panel switch control makes it easy to disable any combination of the three color guns. Eliminates continuous adjustment of the background or screen controls, or connection of a shorting clip inside the receiver. The switch also selects the individual grids of the color tube and connects to a front-panel jack to simplify demodulator alignment.

Provides Switch-Selected R.F. Signals—Factory-tuned, for channels 3, 4, and 5—for open channel use in your area.

Model 850 also includes other features that make it invaluable for home and shop use. Net, \$199⁹⁵

See Your B&K Distributor
or Write for Catalog AP20-E



B & K MANUFACTURING CO.

Division of DYNASCAN CORPORATION

1801 W. BELLE PLAINE AVE. • CHICAGO 13, ILL.

Canada: Atlas Radio Corp., 50 Wingold, Toronto 19, Ont.

Export: Empire Exporters, 253 Broadway, New York 7, U.S.A.

NEW PRODUCTS

6-TURN HELICAL ANTENNAS. Frequency band 300-520 mc, for telemetering. *Model G-1215*, transmitting antenna with type LC connector for power ratings 1 kw average. *Model G-1257*, type N



connector. Both operate in axial mode, circularity 1.5 db. Aluminum.—**Jerrold-Faco**, 15th Lehigh Ave., Philadelphia 32, Pa.

PORTABLE UHF CONVERTER. Adds all uhf stations to present sets. Planetary drive, shielded tuner with 3-gang tuning element. Built-in uhf/vhf coupler permits connection to existing antenna with screwdriver. 11¼ x 5¾ x 3 in. *Model A*, 110-125 volts, 50/60 cycle ac, 10/12 watts at



nominal line voltage. Built-in 117-volt ac power receptacle, 6-ft connecting cord. *Model B* same as above, less 6DS4 nuvistor i.f. amplifier circuit and ac outlet.—**Standard Kollsman Industries, Inc.**, 2085 N. Hawthorne Ave., Melrose Park, Ill.

EDUCATIONAL LAB KIT, model PL-1, for children 7 to 14. 15 electronic circuits, code oscillator to transmitter to receiver; complete Interna-



tional Morse Code; FCC Rules and Regulations governing ham licensing.—**PACO Electronics Co., Inc.**, 70-31 84 St., Glendale 27, N. Y.

MICROMINIATURE SOLDERING IRON, catalog No. H14. For light soldering. 20 watts; ½- and 3/16-in. diam. Xtradur tips. Replaceable element. Ventilated design, concave stainless steel



mirror sends heat away from handle. Lightweight, flexible cord. 2-wire or 3-wire; 115 volts ac or dc; 12, 17 or 20 watts. 5 tip diameters and shapes.—**Hexacon Electric Co.**, 186 W. Clay Ave., Roselle Park, N. J.

MINIATURE SOLDERING IRON, American Beauty B-Series. Floating heating element, pure alumina core, resistance-wire windings, entire element sealed in steel. Polygonal anti-roll baffle. 7 in. long. 3 oz. Screw-in tips. *Model B-2000*; 22½

watts input, 700°F heat at ⅛-in. diam. tip. *Model B-2500*; 30 watts input, 850°F at 3/16-in. tip.—**American Electrical Heater Co.**, 6110 Cass Ave., Detroit 2, Mich.

HAND-SIZE WELDING TORCH, Micro-flame. Fueled by 2 miniature compressed-gas cartridges, oxygen and butane. Welding flame 4,000°F. Easily obtainable gas cartridges contain 2-hour



supply. Precision controls regulate gas mixture, turn torch on and off.—**Printed Circuits, Inc.**, 7800 Computer Ave., Minneapolis, Minn.

CHANNELLOCK SCREW/NUTDRIVERS. Chrome steel, polished plated blades locked into handles. Tips ground lengthwise for greater "end"

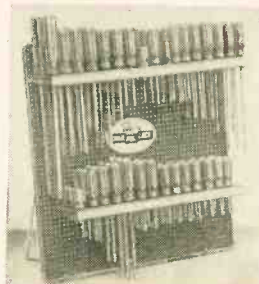

strength. Handles shockproof, breakproof.—**Champion DeArment Tool Co.**, Meadville, Pa.

WIRE STRIPPER, Dial-it. Strips, cuts and loops free-stripping wire. Size of stripping slot controlled by small thumb-dial on handle. Overall

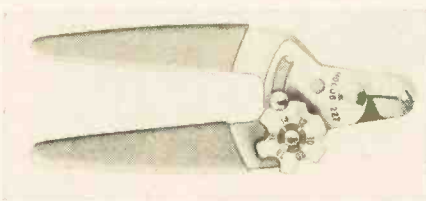

length 5½ in. Small nose for close-quarter work. *No. 227* for No. 10 to 20 wires, *No. 228* for No. 12 to 26 wires.—**Holub Industries, Inc.**, Sycamore, Ill.

COLOR-CODED TOOL SET, Model PS7: 2 nutdrivers (¼-, 5/16-inch hex); 2 slot-tip screwdrivers (3/16-, 3/32-inch) 2 Phillips screwdrivers (No. 0, No. 1). Each 3½ in. long. Piggyback slip-



over handle 1 x 3/8 in. *Model PS120* kit: 10 nutdrivers, hex openings 3/32-3/8 in., torque amplifier. Both in see-through plastic cases.—**Xcelite, Inc.**, Orchard Park, N. Y.

SHRINKABLE TUBING KIT. 6-inch lengths of 5 types FIT tubing, selection of FIT markers (preprinted ¾-in. lengths to identify and protect



wire and cable), FIT caps (short lengths semi-rigid tubing, sealed on one end, to terminate wires and cables). Instructions.—**Alpha Wire Corp.**, 200 Varick St., New York 14, N. Y.

TEST POINT JACK, model SKT-0806. For .080-in. diam. probe. .187 in. long. Beryllium-copper lug extends through Teflon bushing with



above-bushing height .187 in. Overall height of test-point jack. .504 in.; diameter .218 in. In any EIA color for color-coding.—**Sealectro Corp.**, Mamaroneck, N. Y.

CAPACITANCE-RESISTANCE ANALYZER, model TE-46. Accuracy ±5%. 4 direct-reading scales for capacitance and resistance: .00002-.005, .002-.5, 2-50 and 50-2,000 µf; 2-500,

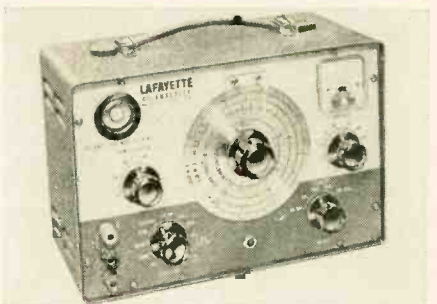

200-50,000 and 20,000 ohms-5 megohms, 5-200 megohms. Measures power factor of electrolytics, shorts, opens, leaky capacitors. Transformer turns-ratio scales: 1:1-10:1, 10:1-200:1. Impedance ratio scales 1:1-100:1, 100:1-40,000:1. Dc leakage test 3-600 volts continuously variable. Measures leakage current in 2 ranges: 0-1 ma, 0-10 ma. Dc insulation test 600 volts constant. Magic-Eye tube for capacitance-resistance indicator. Meter for dc leakage, insulation measurements.—**Lafayette Radio Electronics Corp.**, 111 Jericho Turnpike, Syosset, N. Y.

VOLT-OHM-METER, model 630-NS. 200,000 ohms per vdc, 20,000 ohms per vac. 5-µa current measuring circuit for semiconductor leakage-current measurements. Suspension meter move-



ment, 63 ranges, mirror-scaled. Temperature-compensated, usable with frequencies through 100 kc. Current measurements 0.1 µa-12 amps.—**Triplett Electrical Instrument Co.**, Harmon Rd., Bluffton, O.

SPECIAL INTRODUCTORY OFFER

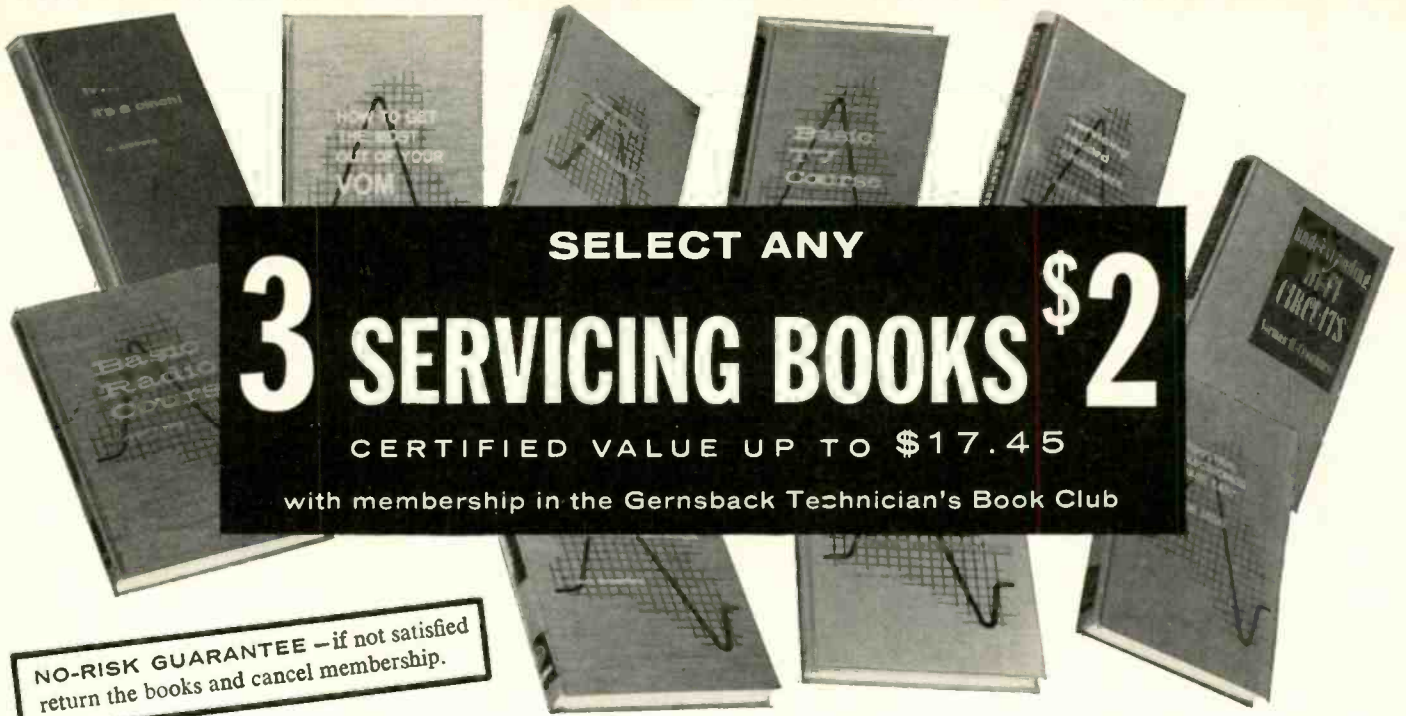

SELECT ANY
3 SERVICING BOOKS \$2

CERTIFIED VALUE UP TO \$17.45

with membership in the Gernsback Technician's Book Club

NO-RISK GUARANTEE — if not satisfied return the books and cancel membership.

WHY THIS SPECTACULAR OFFER?

Gernsback Library is making this offer to persuade more members to join the helpful Technicians Book Club. As striking as this offer is—it is only an introduction to the many advantages club members receive. The club gives you the chance to acquire at bargain prices—books by top technical writers on how to master fundamentals, learn new techniques that will help you get and stay ahead in electronics.

Here's the technical book buy of the year—not a collection of old or outdated volumes—but new books taken from the top of the Gernsback list of best sellers. Priced up to \$5.95 each—total value \$17.45.

WHAT THE CLUB OFFERS YOU

- Selection of the best modern electronics books by first-rank authors.

- Tremendous savings on each book—Club prices range from \$3.25 up for books regularly priced at \$4.60 and more.
- Chance to select one or more valuable books regularly.
- Opportunity to buy books not always available in your community.
- Attractive volumes—carefully printed—handsomely cloth bound.
- Preselection privilege. A newsy bulletin regularly describes each selection and the alternates in detail.
- Budget-coddling payments. You agree to accept as few as four additional books a year. You pay for the books only *after* you receive them—and then only at the special club price—discounts up to 27%.

Highlights from books you will be able to select in coming months

- What you need to know about modern TV.
- All about transistors.
- Math for the electronic technician.
- Getting more out of the oscilloscope.

- Complete book on electricity for technicians.
- Picture book to help you solve tough TV problems.

HOW TO JOIN

- Mail the coupon below and start membership with any 3 of the books listed below. **SEND NO MONEY.** We'll bill you \$2—plus a few cents handling and mailing. If you're not satisfied with the books send them back and membership is cancelled.
- Periodically you will receive a bulletin describing that month's choice and alternates.
- You may select one or more books or reject all books when offered.
- You agree to accept only 4 additional books in the next 12 months. You may cancel anytime after that.
- Mail in the coupon below to Technicians Book Club, Dept. 63, 154 West 14th St., New York 11, N.Y. **SEND NO MONEY NOW** (unless you wish).

Choose the 3 books you want below for only \$2.00

SERVICING RECORD CHANGERS. By Harry Mileaf—Makes servicing changers easy. Complete text plus line drawings explain intricate mechanisms clearly. Reg. price \$4.60.

BASIC RADIO COURSE (revised ed.), By John T. Frye—The original sold out through eight printings! Everything—Ohm's law, capacitance, tubes, transistors and how they work in a receiver—practical servicing techniques—discussed in a lighthearted style that makes what's being taught stick. Reg. price \$5.75.

UNDERSTANDING HI-FI CIRCUITS. By Norman H. Crowhurst—Analyzes the hi-fi system so you can move into audio and hi-fi servicing. Covers inverter, driver and output stages, feedback, damping, matching, crossovers—and much more. Reg. price \$5.00.

PRACTICAL AUTO RADIO SERVICE. By Jack Greenfield—Covers transistor, hybrid FM and AM models. Compares auto with home radio servicing. Covers removal, installation, troubleshooting, power supplies, interference, suppression, tuner theory, etc. Reg. price \$4.60.

INDUSTRIAL ELECTRONICS MADE EASY. By Tom Jaski—Operation and maintenance of industrial equipment, dielectric, induction and microwave heating processes and applications. Control systems actuated by photo-electric, infrared, pressure, and other transducers. Reg. price \$5.95.

TV—IT'S A CINCH! By E. Aisberg—A delightful explanation of TV principles written lightheartedly in dramatic dialogue. Practical approach to TV theory. Reg. price \$4.60.

TRANSISTOR CIRCUITS. By Rufus P. Turner—How to work with hundreds of transistorized circuits. Covers amplifiers, oscillators, power supplies, receivers, test instruments. Reg. price \$4.95.

BASIC TV COURSE. By George Kravitz—A book on TV as it is today. Even transistorized portables are discussed. A thorough practical discussion of circuit operation, sync methods, sweep systems, tuners, amplifiers, variations in power supplies. Presentation of technical detail in easy-to-follow writing style. Reg. price \$5.75.

TV AND RADIO TUBE TROUBLES. By Sol Heller—Trace any tube trouble to the source in minutes with this new sure-fire symptom analysis technique. Save servicing time. Reg. price \$4.60.

HOW TO GET THE MOST OUT OF YOUR VOM. By Tom Jaski—Get more mileage out of this versatile instrument. How to choose, build, work with and extend the use of the VOM. Reg. price \$4.60.

ONLY 3 BOOKS TO A MEMBER PLEASE

TECHNICIAN'S BOOK CLUB

Gernsback Library Dept. 63

154 West 14th Street, New York 11, N.Y.

Enroll me as a member of the G/L Technician's Book Club. Start my membership with the 3 books I've checked for only \$2.00 (plus a few cents postage). Thereafter send me a brochure describing the current selections which I may purchase at special discount prices if I wish. I understand that my only obligation is to purchase just 4 additional books within the next 12 months, and that I may cancel anytime thereafter. I also understand that I may cancel immediately, simply by returning these first 3 books within 10 days.

NAME _____

ADDRESS _____

CITY _____ ZONE _____ STATE _____

NEW MULTIPLEX VERSION OF FAMOUS SCOTT 310 "TELSTAR" FM TUNER



Scott's 310 tuner has long been admired for exceptional sensitivity and selectivity. It is used as a broadcast monitor by FM stations throughout America and was selected by Bell Laboratories for receiving signals from Telstar orbiting in outer space. The new 310E includes exclusive Scott Time-Switching multiplex circuitry, silver-plated front-end, Auto-Sensor for fully automatic reception, precision meter and many other exclusive features. Sensitivity is 1.9 μ V! \$279.95*

H. H. Scott, Inc. Dept. 570-6
111 Powdermill Road, Maynard, Mass.



Rush me complete technical details on new 310-E FM Stereo Tuner.

Name _____

Address _____

City _____ Zone _____ State _____

*Slightly higher West of Rockies. Accessory Case Extra. Export: Morhan Exporting Corp., 458 Broadway, N.Y.C. Canada: Atlas Radio Corp., 50 Wingold Ave., Toronto.

PROFESSIONAL technicians use *Dave Rice's* OFFICIAL ORDER BOOKS for every TV-RADIO service call

This is the businesslike approach to service record keeping. TriPLICATE forms serve as order form, invoice and office record, with spaces for complete information on every job. Separate listings for receiving tubes, pix tube, parts, serial numbers, labor and tax charges, signatures, etc. 75c a book, \$6.50 for dust-proof box of 10. In stock at your distributor.

FREE

Write for your free folder describing Dave Rice's OFFICIAL ORDER BOOKS, including an actual size sample copy of the handy order form.

ELECTRONIC PUBLISHING CO., INC.
133 N. JEFFERSON ST.
CHICAGO 6, ILLINOIS



RADIOTELEPHONE LICENSE MANUAL \$5.75

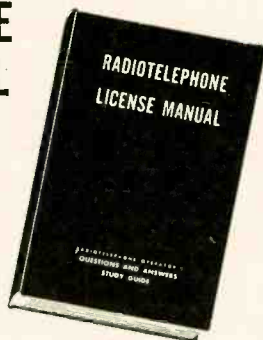

— helps you prepare for all U.S.A. commercial operator's license exams

Here are complete study-guide questions and answers in a single volume. Helps you understand every subject needed to obtain an operator's license.

RADIO HANDBOOK — largest comprehensive reference source on radio ever published. More "How-to-build" data than any book in the field. Gives simplified theory . . . latest design data . . . \$8.50

WORLD'S RADIO TUBES (Brans' Radio Tubes Vade Mecum). World's most authoritative tube book... \$8.00

WORLD'S EQUIVALENT TUBES (Brans' Equivalent Tubes Vade Mecum). Over 32,900 comparisons. . . . \$6.00

SURPLUS RADIO CONVERSION MANUALS

Practical conversions of most popular surplus equipment, in 3 volumes. Send stamped envelope for list of contents . . . each \$3.00

*Order from your favorite electronic parts distributor.

If he cannot supply, send us his name and your remittance, and we will supply; foreign, add 10%.

EDITORS and ENGINEERS, Ltd.

Summerland 5, California



Dealers: Electronic distributors, order from us. Bookstores, libraries, newsdealers order from Baker & Taylor, Hillside, N. J. Export (exc. Canada), order from H. M. Snyder Co., 440 Park Ave. S., N.Y. 16.

IM/HARMONIC DISTORTION METER, AC VTVM, model 902. 4 1/2-in. meter. Full-scale pointer deflection for 0.1% distortion (10 mv ac rms voltage). Linear scale. Precise readings down to .01% and 1 mv ac. 6 full-scale IM ranges to 30% distortion, 7 for harmonic distortion to 100%, 10 for ac voltage to 300 volts rms. \pm 5% for ac-



curacy on distortion. \pm 4% on ac voltage. Selection of 4:1 or 1:1 low- to high frequency ratios. External high-frequency sources down to 2 kc may be used.—Eico Electronic Instrument Co., Inc., 33-00 Northern Blvd., Long Island City 1, N. Y.

MINIATURE PRECISION RESISTORS, models AS-1/2, AS-1. Dissipate 1/2 watt and 1 watt, respectively, at ambient temperatures 125°C. Ratings double at 25°C. AS-1/2: 5/16 in. long, max. diam. 3/32 in.; AS-1: 13/32 in. long, max. diam. 1/8 in. Both in precision tolerances 3%-.05%. Temperature coefficient averages less than \pm 25 ppm/°c. Resistance values 2 to 3 times comparable-size vitreous enamel types.—International Resistance Co., 401 N. Broad St., Philadelphia 8, Pa.

CERAMIC CAPACITORS. Molded. Operate without derating at 200 vdc, -55° to +150°C. Life-tested at 400 vdc. Type CK-05: 10-2,500 pf, 0.1 in. thick x 0.2 in. square; MIL-C-11015/18

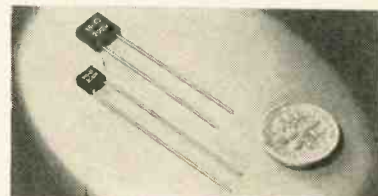

covers 10-1,000 pf only. Type CK-06: 1,001-12,000 pf, 0.1 in. thick x 0.3 in. square; MIL-C-11015/19 covers 1,200-10,000 pf only.—Aerovox Corp., Distributor Div., New Bedford, Mass.

65-MA SELENIUM RECTIFIER, type G165C, rectifies line voltage. For home entertainment and commercial test equipment, small battery chargers, electronic counters and toys. .375-inch thick, less than 1 inch long and wide, includ-

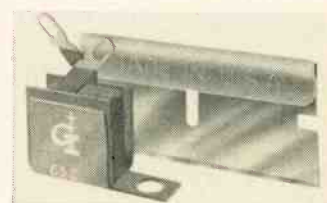

ing mounting. Maximum prv 380 volts, maximum rms input voltage 130 volts.—Rectifier Div., General Instrument Corp., 65 Gouverneur St., Newark 4, N. J.

FM/AM MONO TUNER, model S-2000 II. Gated-beam zero time-constant limiter and balanced ratio detector provide 1.8- μ v FM sensitivity for -30 db quieting and IHFM distortion. FM capture ratio 2.4 db. 15-kc AM bandpass. Front-

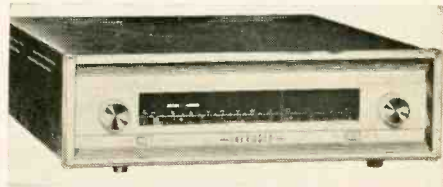

panel switch 5-kc pass-band option to pull in weak AM stations. Afc, front-panel disabling switch option. Flywheel-assisted dial pointer movement. 8 1/4-in. communications-type dial. Acro-beam tuning indicator. Available in professional rack-mount



Original Equipment Designers

Choose Tubes from Complete Stocks at Local RCA Distributor

Just call. And watch your RCA Industrial Tube Distributor perform on any of your OEM or replacement needs for RCA tubes. He carries large inventories. Latest tube types available immediately can help you meet emergency lab requirements, help keep your production schedules rolling.

He can also provide practical application data. When you need it, just ask him.



So. Get to know your local RCA Industrial Tube Distributor...for priority service on quality RCA tubes for color TV, black-and-white TV, AM-FM radio, Hi-Fi, Phonographs, and industrial and communications equipment of every description.

RCA ELECTRON TUBE DIVISION, HARRISON, N. J.



The Most Trusted Name in Electronics

For name and address of your local distributor write or call your nearest RCA Distributor Products Sales Office—New York, N. Y.: 36 W. 49th St., MUrray Hill 9-7200; Needham Heights 94, Mass.: 80 "A" St., Hillcrest 4-8480; Washington 7, D. C.: 1725 "K" St., S.W., FEderal 7-8500; Atlanta, Ga.: 134 Peachtree St., N.W., JAckson 4-7703; Cleveland, Ohio: 1621 Euclid Ave., CHerry 1-3450; Chicago, Ill.: Merchandise Mart, 467-5900; Dallas 7, Texas: 7901 Carpenter Freeway, MEIrose 1-3050; Kansas City 14, Mo.: 7711 State Line, EMerson 1-6462; Los Angeles 22, Cal.: 6801 E. Washington Blvd., RAymond 3-8361.

FOR SHARP, CLEAR 2-WAY COMMUNICATION

Fixed or mobile,
business or pleasure
Get the new, low-cost

RCA MARK VIII

27-Mc Citizens Band Radio-Phone

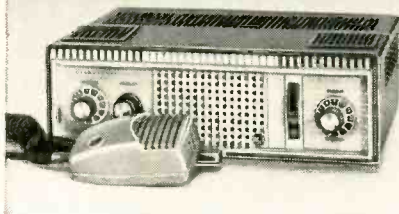

Here's the LOW-COST C-B radio-phone for car, boat, home, office, or shop. High sensitivity receiver pulls in weak signals. 2½ watt speaker output delivers ample volume to overcome engine noise. Automatic noise suppressor minimizes ignition interference. Light and compact—only 3½ inches high, weight only 9 pounds; fits easily under the dashboard of even compact cars.

PLUS THESE PREMIUM FEATURES— RCA MARK VIII RADIO-PHONE

- 9 crystal-controlled transmit and receive channels
- Tunable receiver permits reception of all 23 C-B channels; dial marked in both channel numbers and frequency
- Exceptionally good voice reproduction—high intelligibility
- Excellent modulation characteristics
- Operates from standard 117-volt AC; separate 6- and 12-volt DC power supplies (optional) for mobile installations
- Electronic switching—no relay noise or chatter
- Illuminated "working channel" feature plus many more features to increase usefulness and efficiency.

AC Unit only **\$149.50***

DC Power Supplies, Where Needed, \$19.95*

*Optional list price



The Most Trusted Name
in Electronics

MAIL COUPON FOR MORE INFORMATION

RCA Electron Tube Division
Commercial Engineering Dept. F-39-R
415 South Fifth Street, Harrison, N. J.

Please send more information on the RCA
Mark VIII 27-Mc 2-Way Radio-Phone.

Name _____

Address _____

City _____ Zone _____ State _____

model.—**Sherwood Electronic Labs, Inc.**, 4300 N. California Ave., Chicago 18, Ill.

REMOTE-CONTROL FM TUNER, model MF-300 (illus). Wire or wireless remote. Stereo Beacon signals multiplex broadcasts, automatically switches to proper mode of operation. Wire remote-control station-selector unit with 30-ft. cable, model **RK-10**. Model **RK-20**, wireless remote, controls both tuning and volume without wires or



external connections; receiver and hand-held transmitter.—**Fisher Radio Corp.**, 21-21 44th Dr., Long Island City 1, N. Y.

FM MULTIPLEX STEREO TUNER, model RA-524. Built-in tuning meter. Frequency response 20–20,000 cycles; distortion 1% at 100-mv input;



quieting sensitivity 2 mv for 20 db quieting. Wide-band ratio detector, dual limiters, afc. 110–125 vac, 60 cycles.—**Olson Electronics, Inc.**, 260 S. Forge St., Akron 8, Ohio.

FM MULTIPLEX TUNER KIT, model LT-111. Prewired, prealigned FM multiplex and front end. Pre-aligned i.f. transformers. Afc. Frequency response 20–20,000 cycles ± 0.5 db. Sensitivity 1.4 μ v for 20

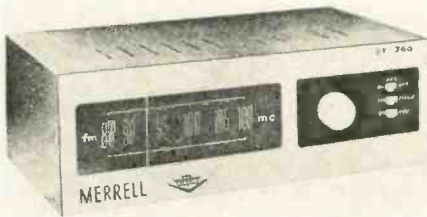

db quieting. Distortion 1%. Output level 2¼ volts at 100% modulation. With or without multiplex, kit or wired.—**Merrell Electronics, Inc.**, 519 Hendrix St., Brooklyn 7, N. Y.

FM STEREO TUNER KIT, model LT-111. Time-switching multiplex circuitry, precision tuning indicator, separate level controls. High-conductivity copper rf front end prewired, prealigned.

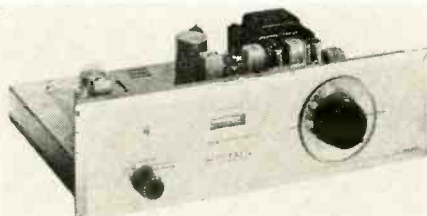

All wires precut and stripped. Usable sensitivity 4.0 μ v, signal-to-noise ratio 55 db, harmonic distortion 0.8%, drift 0.02%. Capture ratio 6 db, selectivity 32 db, IM distortion 0.3%, separation over 30 db. Kit-pack container acts as work table.—**H. H. Scott Inc.**, Dept. P, 111 Powdermill Rd., Maynard, Mass.

STEREO TAPE RECORDER, model 1055. 4-track stereo and mono record/playback; 2-track stereo and mono playback; dual self-contained stereo power amps; professional type VU meter with A-B switch; record switch with record safety interlock; stereo preamp outputs; automatic shut-off, index counter, dual speaker output jacks, stereo-phono-radio inputs; "Edit Guide", built-in

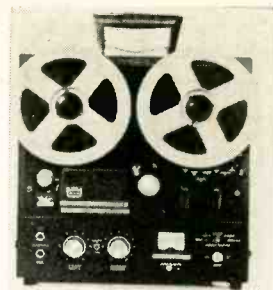

head demagnetizer. For horizontal or vertical installation. Speeds 7½, 3¾ ips; 15-ips accessory kit available. 2 high-impedance mike inputs, 2 high-impedance, high-level phono-radio inputs, 2 high-impedance outputs, two 4–16-ohm outputs for external speakers or low-impedance stereophones.—**Roberts Electronics, Inc.**, 5978 Bowcroft St., Los Angeles 16, Calif.

TRANSISTOR STEREO TAPE RECORDER, model 47/26. 47 transistors, 26 diodes. Self-contained. 10 watts audio power per channel. 2 built-in monitoring speakers, 3 separate motors, 3 separate tapeheads, dual recording and playback amplifiers, 3 individual controls per channel. Automatic rewind, replay and shutoff. 3 individual inputs per channel with simultaneous intermix;



authentic sound-on-sound and echo effects; monitoring from recorded tape or preamp input. Can connect permanently to tuner, record player and external speakers for simultaneous listen and record. Operates in vertical, horizontal or studio-angle position. Frequency response 30–20,000 cycles within 3 db at 7½ ips, to 15,000 cycles at 3¾ ips. Signal-to-noise ratio 50 db down, flutter and wow .15% at 7½ ips. Bias frequency 85 kc, total harmonic distortion 1.0%.—**Vernon Audio Div.**, 144 E. Kingsbridge Rd., Mount Vernon, N. Y.

STEREO AMPLIFIER KIT, model LK-30. Dual tone controls, tape monitor, front-panel stereo headphone output, derived center-channel out-

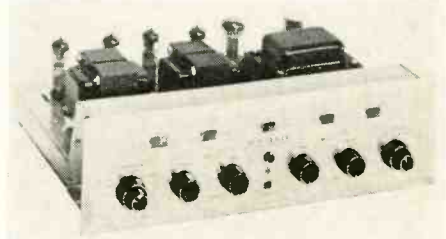

put, all-aluminum chassis, scratch filter, stereo balancing. IHFM power rating 30 watts, power band 25–19,000 cycles. Distortion 0.8%, hum and noise –70 db; frequency response 20–20,000 cycles, 1 db.—**H. H. Scott, Inc.**, Dept. P, 111 Powdermill Rd., Maynard, Mass.

ELECTRONIC ORGAN KIT, York. Theater type horseshoe console for limited space. 2 full-size 61-note manuals. 25-note pedal keyboard, dual expression pedals, 40 multicolored stop tabs. Com-



RAD-TEL'S

1 for 1 TUBE SALE!

Your Choice

* 29¢

each



*RAD-TEL'S SPECIAL OFFER

For every Rad-Tel quality Brand New Tube you buy, as advertised—Rad-Tel will give you your choice of a Brand New 5U4 or 6J6 tube for only 29¢ each!!

LIMITED TIME OFFER—ORDER NOW!

ONE YEAR GUARANTEE

ONE DAY SERVICE—OVER 500 TYPES IN STOCK

up to **75% OFF****

Rad-Tel's Quality
BRAND NEW TUBES

** Manufacturers Suggested List Price

FREE! Send For New Tube & Parts Catalog
Send For Trouble Shooting Guide

Be your own **TELEVISION REPAIRMAN**

The Original NOW YOU CAN
FIX YOUR OWN TV SET BOOK

You can fix your own TV if you have TV Fixit Book . . . because 80% of troubles are caused by tubes. This book explains, illustrates trouble and what tubes cause this trouble. Pinpoints in over 3000 layouts by model number, position and type tube causing trouble.

\$1.00

No. 170

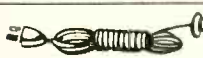

CHEATER CORD

Easy to work on
set while panel is off.

6 ft., No. 154 **29¢ ea.** Lots of 3—25¢ ea.



RAD-TEL TUBE CO.

TV, RADIO
AND HI-FI

DEPT. RE-6 55 CHAMBERS STREET, NEWARK 5, NEW JERSEY

TERMS: 25% deposit must accompany all orders, balance C.O.D. Orders under \$5: add \$1 handling charge plus postage. Orders over \$5: plus postage. Approx. 8 tubes per 1 lb. Subject to prior sale. No C.O.D.'s outside continental U.S.A.

EACH TUBE ATTRACTIVELY BOXED & BRANDED RAD-TEL

Qty.	Type	Price	Qty.	Type	Price	Qty.	Type	Price	Qty.	Type	Price
—	0Z4	.79	—	6AU8	.87	—	6K6	.63	—	12CU5	.58
—	1AX2	.62	—	6AV6	.41	—	6S4	.52	—	12CU6	1.06
—	1B3	.79	—	6AW8	.90	—	6SA7GT	.99	—	12CX6	.54
—	1DN5	.55	—	6AX4	.66	—	6SH7	1.02	—	12D4	.69
—	1G3	.79	—	6AX5	.74	—	6SJ7	.88	—	12DE8	.83
—	1J3	.79	—	6BA5	.50	—	6SK7GT	.95	—	12DL8	.88
—	1K3	.79	—	6BC5	.61	—	6SL7GT	.84	—	12DQ6	1.04
—	1R5	.77	—	6BC8	1.04	—	6SN7	.65	—	12DS7	.84
—	1S5	.75	—	6BE6	.55	—	6SQ7GT	.94	—	12DT5	.76
—	1T4	.72	—	6BF5	.90	—	6T4	.99	—	12DT7	.79
—	1U5	.65	—	6BF6	.44	—	6T8	.85	—	12DT8	.78
—	1X2B	.82	—	6BG6	1.70	—	6U8	.83	—	12DW8	.89
—	2AF4	.96	—	6BH8	.98	—	6V6GT	.54	—	12DZ6	.62
—	3AL5	.46	—	6BJ6	.65	—	6W4	.61	—	12ED5	.62
—	3AU6	.54	—	6BJ7	.79	—	6W6	.71	—	12EG6	.62
—	3AV6	.42	—	6BK7	.85	—	6X4	.41	—	12EK6	.62
—	3BC5	.63	—	6BL7	1.09	—	6X8	.80	—	12EL6	.50
—	3BN6	.75	—	6BN6	.74	—	7A8	.68	—	12EZ6	.57
—	3BU8	.78	—	6BQ6	1.12	—	7AU7	.65	—	12F8	.66
—	3BY6	.58	—	6BQ7	1.00	—	7EY6	.75	—	12FA6	.79

—	3BZ6	.56	—	6BU8	.70	—	7Y4	.69	—	12FM6	.50
—	3CB6	.56	—	6BX7	1.11	—	8AU8	.90	—	12FR8	.97
—	3CS6	.58	—	6BZ6	.55	—	8AW8	.93	—	12FX8	.90
—	3DG4	.85	—	6BZ7	1.03	—	8BQ5	.60	—	12GC6	1.06
—	3DK6	.60	—	6C4	.45	—	8CG7	.63	—	12J8	.84
—	3DT6	.54	—	6CB6	.55	—	8CM7	.70	—	12K5	.75
—	3GK5	.99	—	6CD6	1.51	—	8CN7	.97	—	12L6	.73
—	3Q4	.63	—	6CG7	.61	—	8CS7	.74	—	12SF7	.69
—	3S4	.75	—	6CG8	.80	—	8EB8	.94	—	12SK7GT	.95
—	3V4	.63	—	6CL8	.79	—	8FQ7	.56	—	12SL7	.80
—	4BQ7	1.01	—	6CM7	.69	—	9CL8	.79	—	12SN7	.67
—	4CS6	.61	—	6CN7	.70	—	11CY7	.75	—	12SQ7GT	.91
—	4DT6	.55	—	6CQ8	.92	—	12A4	.60	—	12U7	.62
—	4GM6	.60	—	6CR6	.60	—	12AB5	.60	—	12V6	.63
—	5AM8	.79	—	6CS6	.57	—	12AC6	.55	—	12W6	.71
—	5AN8	.90	—	6CS7	.69	—	12AD6	.57	—	12X4	.47

RAD-TEL TUBE CO. NOT AFFILIATED WITH ANY OTHER MAIL ORDER TUBE COMPANY

—	5AQ5	.54	—	6CU5	.58	—	12AE6	.50	—	17AX4	.67
—	5AT8	.83	—	6CU6	1.08	—	12AE7	.94	—	17DQ6	1.06
—	5BK7	.86	—	6CY5	.70	—	12AF3	.73	—	18FW6	.49
—	5BQ7	1.01	—	6CY7	.71	—	12AF6	.67	—	18FX6	.53
—	5BR8	.83	—	6DA4	.68	—	12AJ6	.62	—	18FY6	.50
—	5CG8	.81	—	6DE6	.61	—	12AL5	.47	—	19AU4	.87
—	5CL8	.76	—	6DG6	.62	—	12AL8	.95	—	19BG6	1.39
—	5CQ8	.84	—	6DJ8	1.21	—	12AQ5	.60	—	19EA8	.79
—	5EA8	.80	—	6DK6	.59	—	12AT6	.50	—	19T8	.85
—	5EU8	.80	—	6DN6	1.55	—	12AT7	.76	—	21EX6	1.49
—	5J6	.72	—	6DQ6	1.10	—	12AU6	.51	—	25AX4	.70
—	5T8	.86	—	6DT5	.81	—	12AU7	.61	—	25C5	.53
—	5U4	.60	—	6DT6	.53	—	12AV6	.41	—	25CA5	.59
—	5U8	.84	—	6DT8	.94	—	12AV7	.82	—	25CD6	1.52
—	5V6	.56	—	6EA8	.79	—	12AX4	.67	—	25CU6	1.11
—	5X8	.82	—	6EB5	.73	—	12AX7	.63	—	25DN6	1.42

—	5Y3	.46	—	6EB8	.94	—	12AY7	1.44	—	25EH5	.55
—	6AB4	.46	—	6EM5	.77	—	12AZ7	.86	—	25L6	.57
—	6AC7	.96	—	6EM7	.82	—	12B4	.68	—	25W4	.68
—	6AF4	1.01	—	6EU8	.79	—	12BD6	.50	—	32ET5	.55
—	6AG5	.70	—	6EV5	.75	—	12BE6	.53	—	35C5	.51
—	6AH4	.81	—	6EW6	.57	—	12BF6	.60	—	35L6	.60
—	6AH6	1.10	—	6EY6	.75	—	12BH7	.77	—	35W4	.42
—	6AK5	.95	—	6FG7	.69	—	12BK5	1.00	—	35Z5	.60
—	6AL5	.47	—	6FV8	.79	—	12BL6	.56	—	36AM3	.36
—	6AM8	.78	—	6GH8	.80	—	12BQ6	1.16	—	50B5	.69
—	6AQ5	.53	—	6GK5	.61	—	12BR7	.74	—	50C5	.53
—	6AS5	.60	—	6GK6	.79	—	12BV7	.76	—	50EH5	.55
—	6AT6	.49	—	6GN8	.94	—	12BY7	.77	—	50L6	.61
—	6AT8	.86	—	6HG6	.58	—	12BZ7	.86	—	70L7	.97
—	6AU4	.85	—	6J5GT	.51	—	12CN5	.56	—	117Z3	.85
—	6AU6	.52	—	6J6	.71	—	12CR6	.67	—	807	.75

ORDER FORM MAIL TODAY

RAD-TEL Tube Co.

Dept. RE-6

55 Chambers Street

Newark 5, New Jersey

Total Tubes \$ _____

Total Part(s) \$ _____

Postage \$ _____

Grand Total \$ _____

ENCLOSED IS \$ _____ Please rush order.

_____ Book(s) Be Your Own TV Repairman @ \$1.00 ea. #170

SEND: _____ Cheater Cord 29c ea. Lots of 3 - 25c ea. #154

Orders under \$5.00 - Add \$1.00 handling charge - plus postage.

FREE! Send FREE Tube and Parts Catalog

Send FREE Trouble Shooting Guide

NAME _____

ADDRESS _____

CITY _____ ZONE _____ STATE _____

plete kit or smaller component kits consisting of tone generators, tone changers, pedal keyboard, manuals and console. Optional accessories: chimes, band box, glockenspiel, speakers, amplifiers. Played through hi-fi mono or stereo system or optional audio components.—**Artisan Organs**, 2476 N. Lake Ave., Alhadena, Calif.

TONE-ARM SWITCH, model 404. Connects 2 tone arms to mono or stereo equalizer, lets operator shift from one to the other. For broadcast,

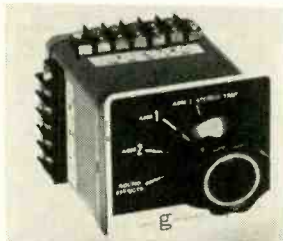

recording. In record cutting, provides groove noise information for controlling stylus heat.—**Gray Research & Development Co.**, Box 12, Elmwood, Conn.

2-SPEED TURNTABLE. Identical to manufacturer's single-speed table except for 2-step drive pulley. Available conversion kit (illus.) with

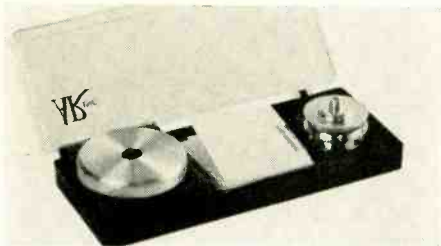

45-rpm spindle adapter, 2-step pulley, installation instruction. Aluminum, machined to .0005-in. accuracy.—**Acoustic Research, Inc.**, 24 Thorndike St., Cambridge 41, Mass.

CERAMIC MICROPHONES, model CM-40 (illus.) and CM-41 Ceramic. Swing type stand, 5-ft shielded cable, phone plug. Frequency re-

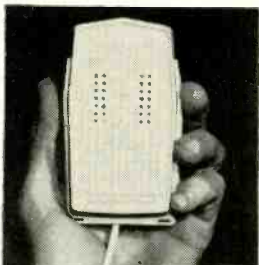

sponse 40-8,000 cycles, sensitivity -50 db. CM-41: push-to-talk "long-travel" dpdt switch.—**Sonotone Corp.**, Elmsford, N. Y.

RECORD-CARE KIT. Plastic-enclosed package, 13 x 13 in.: 12 contour record covers, wiping pad, 45-rpm adapters. Electro-wipe cleaning cloth, needle cleaning brush. Selecto-brush, needle re-



placement screwdriver, mirror, bottle of anti-static detergent.—**Duotone**, Locust St., Keyport, N. J.

PASSIVE RECORD EQUALIZER, model 604-M/S. Feeds constant velocity output of stereo or mono magnetic cartridges into low-impedance mike channels on stereo mixing console. Automatically compensates for cartridge output and recording characteristics. Interchangeable with model 602-C equalizer. Control chassis provides smooth switching from mono to stereo discs and to 16-in. broadcast transcriptions. 2 high-frequency

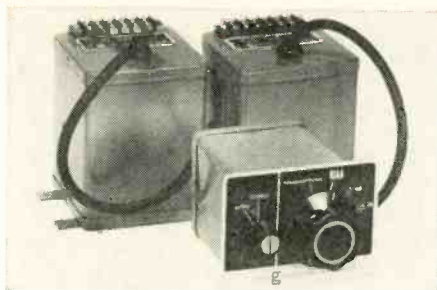

rolloff positions for noisy records.—**Gray Research & Development Co., Inc.**, Box 12, Elmwood, Conn.

RECORD CLEANER. Anti-static detergent, groove-penetrating applicator and needle brush in rigid plastic case.—**Lektrostat Corp.**, 845 Edgewater Rd., New York 59, N. Y.



TEST RECORDS. STR 130, RIAA Frequency Response, sets response of recording equipment, tests electrical systems and response of combined pickups and networks of phonographs. Spot fre-



quency tones with voice announcements included. STR 140, RIAA Pink Noise Acoustical Test Record, for acoustical tests measuring overall response of system, including speaker.—**CBS Labs**, Acoustics & Magnetics Dept., High Ridge Rd., Stamford, Conn.

8-INCH HI-FI SPEAKER, model WR8-BH, for bookshelf, stereo, mono or communications. Frequency range 45-20,000 cycles, impedance 8 ohms. Handles 20 watts average program material, peaks to 40 watts. Built-in cone radiator matches

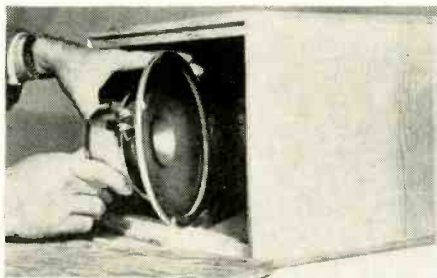

main cone, no dip in vicinity of 6-kc crossover frequency. Alnico V magnet. Color-coded screw type terminal connections. 8 x 4 1/2 in.—**Sonotone Corp.**, Elmsford, N. Y.

OUTDOOR SPEAKER SYSTEM, model CLC. U-bracket for vertical or horizontal mounting with screwdriver. Response 55-14,000 cycles,



power rating 30 watts. Dispersion 90°, impedance 8 ohms. May be used indoors.—**University Loudspeakers**, 80 S. Kensico Ave., White Plains, N. Y.

GENERAL-PURPOSE HEADSET for radio operators, hobbyists, communications work and language labs. Magnetic driver, response to 10,000 cycles. Rust-, moisture-proof. High-impact plastic



and stainless steel.—**Telex, Inc.**, 3054 Excelsior Blvd., Minneapolis 16, Minn.

STEREO DYNAMIC HEADPHONES, Type A. 7-oz. unit has vinyl-covered ear cushions, replaceable parts. Frequency range 20-17,000 cycles, impedance 8 ohms per channel.—**R-Columbia Products Co.**, 2008 St. Johns Ave., Highland Park, Ill.

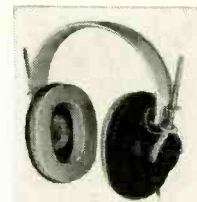

PRINTED-CIRCUIT RADIO KIT, model KB-150. Easy-to-read layout data for each component, cabinet and built-in antenna. Kit AS-533;

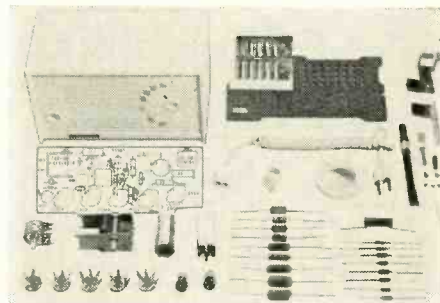

five tubes for above radio.—**Olson Electronics, Inc.**, 260 S. Forge St., Akron 8, Ohio.

CB RADIO, kit MW-33 Marine. For marine, fixed or mobile use. Rf stage, 5 crystal-controlled transmit/receive channels, half-lattice crystal filter,



variable receiver tuning of all channels, 3-way power supply (6 or 12 vdc, 117 vac). Adjustable squelch, automatic noise limiter. Max. allowable input (5 watts). Built-in tuning meter. Mike, ac and dc power cables; crystals for one channel.—**Heath Co.**, Benton Harbor, Mich.

CB FILTER, model CB-T. Suppresses second harmonic generated by CB transmitters. Multisection filter circuit; 30-db attenuation of signals



above 28 mc, insertion loss 1 db. Special input and output tuning trimmers for exact matching of transmitter to antenna.—**Gavin Instruments, Inc.**, Depot Square & Division St., Somerville, N. J. END

All specifications are from manufacturers' data

NEW ADDED FEATURES—NEW LOW COST

The Famous RCA

SENIOR VOLTOHMYST®

NOW AVAILABLE AS A KIT
FOR ONLY \$57.95*

Added features for extra versatility. An improved kit version of the famous RCA SENIOR VOLTOHMYST.

Most important new feature: a half-volt full-scale DC range for more accurate measuring of low voltages used in transistor circuits.

Extra plus feature: Pre-assembled, factory-tested DC/AC-OHMS probe (WG-299D) included with every kit.

Other deluxe features:

- Big 6½" meter—one of the most readable ever designed into a VTVM—electronically protected against burnout
- Color-coded scales differentiate peak-to-peak and rms readings
- ±3% accuracy full-scale on both AC and DC measurements.
- Less than 1% tracking error
- Precision multiplier resistors accurate to ±1%
- Rugged die-cast aluminum case with leather handle
- Brushed aluminum control panel with etched markings

MEASURES: { AC voltages (0.1 to 4200 volts peak-to-peak and 0.1 to 1500 volts rms)
DC voltages (0.005 to 1500)
Resistances (0.2 ohms to 1,000 megohms)

RCA Senior VoltOhmyst WV-98C, also available factory-wired and calibrated, \$79.50*

OTHER OUTSTANDING RCA KIT VALUES



RCA VOLTOHMYST® KIT
WV-77E(K) Only \$29.95*

Famous VoltOhmyst® quality and performance at a low price! Special test features include: separate 1.5-volt rms and 4-volt peak-to-peak scales for accurate low AC measurements. Measures AC and DC voltages to 1500 volts, resistances from 0.2 ohm to 1,000 megohms. Complete with ultra-slim probes, long flexible leads, special holder on handle to store leads.

RCA WV-77E available factory-wired and calibrated: \$43.95*



RCA WV-38A(K)
VOLT-OHM-MILLIAMMETER KIT
Only \$29.95*

The V-O-M with the extras! • 0.25-volt and 1.0-volt DC ranges • Big easy-to-read 5¼" meter • Non-breakable sealed plastic case—no glass to crack or shatter • Jacks located below switches to keep leads out of the way • Spring clips on handle to hold leads • Attractive, scuff resistant, rugged carrying case, only \$4.95* extra.

RCA WV-38A available factory-wired and calibrated: \$43.95*



RCA SUPER-PORTABLE
OSCILLOSCOPE
KIT WV-33A(K) Only \$79.95*

Now in kit form. A 'scope you can carry anywhere! Rugged and compact, yet weighs only 14 pounds. Just right for in-the-home and shop troubleshooting and servicing of black-and-white and color TV, radio, hi-fi components, tape recorders, etc. Ample gain and bandwidth for the toughest jobs. Scaled graph screen and internal calibrating voltage source for direct reading of peak-to-peak voltage.

RCA WV-33A available factory-wired and calibrated: \$129.95*

Call your Authorized
RCA Test Equipment Distributor



The Most Trusted Name in Electronics

RCA ELECTRON TUBE DIVISION, HARRISON, N. J.

*User Price (Optional)

BECOME A RADIO TECHNICIAN
for only \$26.95

BUILD 20 RADIO

CIRCUITS AT HOME

with the New Progressive
RADIO "EDU-KIT"®

Reg. U.S.
Pat. Off.

All Guaranteed to Work!

PRACTICAL only
HOME \$26.95
RADIO
COURSE



TRAINING ELECTRONICS
TECHNICIANS SINCE 1946

- NOW INCLUDES**
- ★ 12 RECEIVERS
 - ★ 3 TRANSMITTERS
 - ★ SQ. WAVE GENERATOR
 - ★ AMPLIFIER
 - ★ SIGNAL TRACER
 - ★ SIGNAL INJECTOR
 - ★ CODE OSCILLATOR

- ★ No Knowledge of Radio Necessary
- ★ No Additional Parts or Tools needed
- ★ Excellent Background for TV
- ★ School Inquiries Invited
- ★ Attractively Gift Packed

FREE EXTRAS

- SET OF TOOLS • RADIO & ELECTRONICS TESTER • ELECTRIC SOLDERING IRON • TESTER INSTRUCTION MANUAL • MEMBERSHIP IN RADIO-TV CLUB: CONSULTATION SERVICE • HI-FI GUIDE
- QUIZZES • TV BOOK • FCC AMATEUR LICENSE TRAINING
- RADIO BOOK • PRINTED CIRCUITRY • PLIERS-CUTTERS
- ALIGNMENT TOOL • WRENCH SET • CERTIFICATE OF MERIT
- VALUABLE DISCOUNT CARD

WHAT THE "EDU-KIT" OFFERS YOU

The "Edu-Kit" offers you an outstanding PRACTICAL HOME RADIO COURSE at a rock-bottom price. Our kit is designed to train Radio & Electronics Technicians, making use of the most modern methods of home training. You will learn radio theory, construction, servicing, basic Hi-Fi and TV repairs, code, FCC amateur license requirements.

You will learn how to identify radio symbols, how to read and interpret schematics, how to mount and lay out radio parts, how to wire and solder, how to operate electronic equipment, how to build radios. Today it is no longer necessary to spend hundreds of dollars for a radio course. You will receive a basic education in radio, worth many times the small price you pay, only \$26.95 complete.

THE KIT FOR EVERYONE

The Progressive Radio "Edu-Kit" was specifically prepared for any person who has a desire to learn Radio. The "Edu-Kit" has been used successfully by young and old in all parts of the world, by many Radio Schools and Clubs in this country and abroad, and is used for training and rehabilitation of Armed Forces Personnel and Veterans throughout the world.

The Progressive Radio "Edu-Kit" requires no instructor. All instructions are included. Every step is carefully explained. You cannot make a mistake.

PROGRESSIVE TEACHING METHOD

The Progressive Radio "Edu-Kit" is the foremost educational radio kit in the world, and is universally accepted as the standard in the field of electronics training. The "Edu-Kit" uses the modern educational principle of "Learn by Doing." Therefore, you will construct radio circuits, perform jobs and conduct experiments to illustrate the principles which you learn.

You begin by examining the various radio parts included in the "Edu-Kit." You then learn the function, theory and wiring of these parts. Then you build a simple radio. With this first set, you will enjoy listening to regular broadcast stations, learn theory, practice testing and troubleshooting. Then you build a more advanced radio, learn more advanced theory and techniques. Gradually, in a progressive manner, and at your own rate, you will find yourself constructing more advanced multi-tube radio circuits, and doing work like a professional Radio Technician.

Included in the "Edu-Kit" course are twenty Receiver, Transmitter, Code Oscillator, Signal Tracer, Signal Injector, Square Wave Generator and Amplifier circuits. These are not unprofessional "breadboard" experiments, but genuine radio circuits, constructed by means of professional wiring and soldering on metal chassis, plus the new method of radio construction known as "Printed Circuitry." These circuits operate on your regular AC or DC house current.

In order to provide a thorough, well-integrated and easily-learned radio course, the "Edu-Kit" includes practical work as well as theory; troubleshooting in addition to construction; training for all, whether your purpose in learning radio be for hobby, business, or job; progressively-arranged material, ranging from simple circuits to well-advanced topics in Hi-Fi and TV. Your studies will be further aided by Quiz materials and our well-known FREE Consultation Service.

THE "EDU-KIT" IS COMPLETE

You will receive all parts and instructions necessary to build 20 different radio and electronics circuits, each guaranteed to operate. Our Kits contain tubes, tube sockets, variable, electrolytic, mica, ceramic and paper dielectric condensers, resistors, tie strips, coils, hardware, tubing, punched metal chassis, Instruction Manuals, hookup wire, solder, selenium rectifiers, volume controls, switches, knobs, etc.

In addition, you receive Printed Circuit materials, including Printed Circuit chassis, special tube sockets, hardware and instructions. You also receive a useful set of tools, a professional electric soldering iron, and a self-powered Dynamic Radio & Electronics Tester. The "Edu-Kit" also includes Code Instructions and the Progressive Code Oscillator, in addition to the F.C.C.-type Questions and Answers for the Progressive Signal Tracer and the Progressive Signal Injector, and a High Fidelity Guide and Quiz Book. Everything is yours to keep.

J. Statistis, of 25 Poplar Pl., Waterbury, Conn., writes: "I have repaired several sets for my friends, and made money. The "Edu-Kit" paid for itself. I was ready to spend \$240 for a course, but I found your ad and sent for your Kit."

UNCONDITIONAL MONEY-BACK GUARANTEE

The Progressive Radio "Edu-Kit" has been sold to many thousands of individuals, schools and organizations, public and private, throughout the world. It is recognized internationally as the ideal radio course.

By popular demand the Progressive Radio "Edu-Kit" is now available in Spanish as well as English.

It is understood and agreed that should the Progressive Radio "Edu-Kit" be returned to Progressive "Edu-Kits" Inc., for any reason whatever, the purchase price will be refunded in full, without quibble or question, and without delay.

The high recognition which Progressive "Edu-Kits" Inc. has earned through its many years of service to the public is due to its unconditional insistence upon the maintenance of perfect engineering, the highest instructional standards, and 100% adherence to its Unconditional Money-Back Guarantee. As a result, we do not have a single dissatisfied customer throughout the entire world.

ORDER FROM AD—RECEIVE FREE BONUS RESISTOR AND CONDENSER KITS WORTH \$7.00

- Send "Edu-Kit" Postpaid. I enclose full payment of \$26.95.
- Send "Edu-Kit" C.O.D. I will pay \$26.95 plus postage.
- Send me FREE additional information describing "Edu-Kit."

Name.....

Address.....

Progressive "EDU-KITS" Inc.

1186 Broadway, Dept. 209G
Hewlett, N. Y.

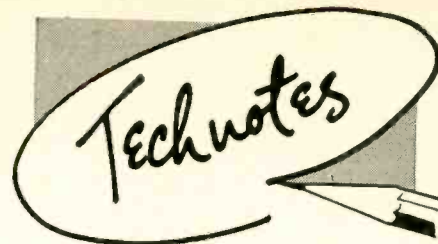

RCA 6-BX-5

Every so often one of these radios comes in with the complaint of short A-battery life—the customer usually complains that you've been selling her old batteries. Excessive leakage in filter capacitor section C7-c is usually the real cause. To check for leakage, turn the set off and insert a milliammeter in series with the battery. Be sure that the line cord plug is inserted in the function switch for battery operation. Under these conditions, battery current should be less than 50µa. If current reading is higher, replace the filter.—*C. S. Lawrence*

Waterman 3-Inch Scope

Complaint: Intermittent vertical amplifier in a Signal Corps BC-1060A.

Cure: Replace R51 (common screen resistor for 6SJ7's). See Fig. 1.

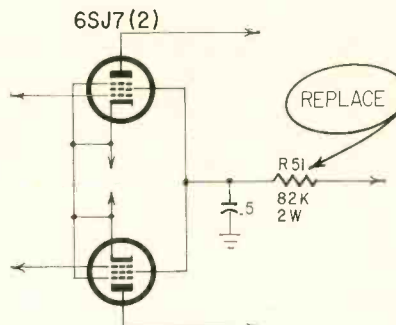

Fig.1

Complaint: Hazy focus; focus control not working. Vtvm checks everything OK.

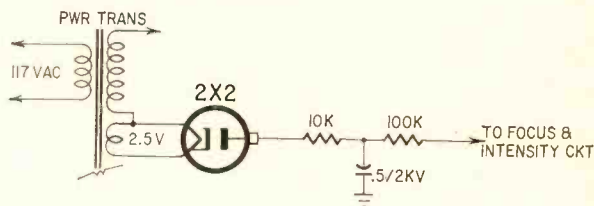

Fig.2

Cure: C43, an 0.5 µf, 2,000-volt capacitor was intermittent. It let through enough ripple to blur the spot and trace (see Fig. 2).—*Cappaert Pierre*

Motorola Chassis TS-544

The set came in with a smeared picture. Circuit checks revealed that age voltage was low, too. After carefully checking the video output circuit, we found that the 5,600-ohm 5-watt resistor (R126) in the 12BY7's plate circuit was open. We replaced it with a new 5,600-ohm 5-watt unit to restore normal operation.—*M. L. Leonard*

Battery Life-Test Circuit

Some recent models of Motorola transistor radios have a little pushbutton switch on the front panel that lets the user check for weak batteries. Spotting the batteries before they are completely dead makes it possible to get new ones before the set becomes completely inoperative.

The pushbutton is a spst momentary-contact switch in

\$1⁰⁰

BUYS more at BROOKS

\$1⁰⁰

You can PROVE to yourself why "BROOKS" OFFERS the BEST BUYS at LOWEST PRICES
SEND YOUR ORDER TODAY—10% off + Free Gift on orders of \$10 & Over (ON DOLLAR BUYS)

- \$15.00 RADIO PARTS "JACK-POT" handy assortment \$1
- 20—ASST. ROTARY SWITCHES \$1
all popular types over \$20 value
- 1—LB SPOOL ROSIN-CORE SOLDER 40/60 \$1
- WEBSTER STEREO CARTRIDGE #SO-2, standard for all pickups \$1
- 6—TV ALIGNMENT TOOLS \$1
- 7—TRANS. RADIO BATTERIES \$1
9 volt, same as Eveready #216
- 1—EMERGENCY AUTO LAMP Red dome blinker, incl Battery \$1
- 1—6" x 9" OVAL PM SPEAKER (one to a customer) \$1
- 1—5" PM SPEAKER \$1
Alnico #5 magnet
- 1—4" PM SPEAKER \$1
Alnico #5 magnet
- 1—2 1/2" PM SPEAKER \$1
small but mighty in tone
- 3—AUDIO OUTPUT TRANSFORMERS 50L6 type \$1
- 3—AUDIO OUTPUT TRANSFORMERS 6K6 or 6V6 type \$1
- 3—I.F. COIL TRANSFORMERS 456kc, most popular type \$1
- 15—RADIO OSCILLATOR COILS standard 456kc \$1
- 3—I.F. COIL TRANSFORMERS 10.7mc for FM \$1
- 2—G.E. #RTL-143 I.F. COIL TRNSFRMRS 456kc w/blank \$1
- 3—I.F. COIL TRANSFORMERS 202kc for Auto Radios \$1
- 4—OVAL LOOP ANTENNAS assorted popular sizes \$1
- 3—LOOPSTICK ANTENNAS hi-gain, ferrite, adjustable \$1
- 3—1/2 MEG VOLUME CONTROLS with switch, 3" shaft \$1
- 5—ASST. 4 WATT WIREWOUND CONTROLS \$1
- 10—ASSORTED VOLUME CONTROLS less switch \$1
- 5—ASSORTED VOLUME CONTROLS with switch \$1
- 3—SPEAKER CABINETS for 2 1/2" to 3" spkr, all purpose \$1
- 5—1/2 MEG VOLUME CONTROLS less switch \$1
- 10—SURE-GRIP ALLIGATOR CLIPS 2" plated \$1
- 10—SETS PHONO PLUGS & PIN JACKS RCA type \$1
- 20—ASST. PILOT LIGHTS #44, 46, 47, 51, etc. \$1
- 50—ASSORTED TERMINAL STRIPS 1, 2, 3, 4 lugs \$1
- 100—FINEST NYLON DIAL CORD best size, .028 gauge \$1
- 50—ASST. RADIO KNOBS screw and push-on types \$1
- 25—ASST. CLOCK RADIO KNOBS in colors \$1
- 25—ASSORTED PRINTED CIRCUIT SOCKETS best types \$1

- 100—ASSORTED 1/2 WATT RESISTORS some in 5% \$1
- 70—ASSORTED 1 WATT RESISTORS some in 5% \$1
- 35—ASSORTED 2 WATT RESISTORS some in 5% \$1
- 20—ASST. DIODE CRYSTALS fine assortment. Latest types \$1
- 2—SYLVANIA EPOXY SILICON RECTIFIERS 750ma-400 piv \$1
- 20—ASS'TED WIREWOUND RESISTORS 5, 10, 20 watt \$1
- 10—ASST. RADIO ELECTROLYTIC CONDENSERS \$1
- 5—ASST. TV ELECTROLYTIC CONDENSERS \$1
- 50—ASST MOLDED CONDENSERS short leads \$1
- 20—GOODALL TUBULAR CONDENSERS .047-600v \$1
- 30—MICAMOLD ASST TUBULAR COND. molded stentite \$1
- 300—ASST. 1/2 W RESISTORS Top Brand, Short leads, excellent \$1
- 10—6' ELECTRIC LINE CORDS with plug \$1
- 4—50' SPOOLS HOOK-UP WIRE 4 different colors \$1
- 50—STRIPS ASSORTED SPAGHETTI handy sizes \$1
- 100—ASSORTED RUBBER GROMMETS best sizes \$1
- 200'—BUSS WIRE #20 tinned for hookups, special circuits, etc. \$1
- 250—ASST. SOLDERING LUGS best types and sizes \$1
- 250—ASST. SELF TAPPING SCREWS #6, #8, etc. \$1
- 150—ASST. 6/32 SCREWS and 150 6/32 HEX NUTS \$1
- 150—ASST. 8/32 SCREWS and 150—8/32 HEX NUTS \$1
- 150—6/32 HEX NUTS and 150—8/32 HEX NUTS \$1
- 8—ASST. LUCITE CASES hinged cover, handy for parts \$1
- 4—TOGGLE SWITCHES SPST, SPDT, DPST, DPDT \$1
- 10—ASSORTED SLIDE SWITCHES SPST, DPDT, etc. \$1
- 100—ASST RUBBER & FELT FEET FOR CABINETS best sizes \$1
- 50—100K 1/2 WATT RESISTORS 10% \$1
- 50—470K 1/2 WATT RESISTORS 10% \$1
- 50—ASST. MICA CONDENSERS some in 5% \$1
- 50—ASST. DISC CERAMIC CONDENSERS popular numbers \$1
- 25—ASSORTED MICA TRIMMER CONDENSERS \$1
- 3—SELENIUM RECTIFIERS 2—65ma and 1—75ma \$1
- 2—SELENIUM RECTIFIERS 1—100 ma and 1—250 ma \$1
- 2—SELENIUM RECTIFIERS 1—65ma and 1—450ma \$1

- \$15.00 TELEVISION PARTS "JACKPOT" best buy ever \$1
- 90° TV DEFLECTION YOKE \$1
wired network, schematic diag.
- 90° FLYBACK TRANSFORMER \$1
schematic shows many uses
- 70° TV DEFLECTION YOKE \$1
wired network, long leads
- 50—ASSORTED TV COILS I.F. video, sound, ratio, etc. \$1
- 1—S10 INDOOR TV ANTENNA hi-gain, 3 section, tiltproof \$1
- 5—TV CHEATER CORDS with both plugs \$1
- 3—ELECTROLYTIC CONDENSERS 50/30-150v \$1
- 100'—TWIN TV LEAD-IN WIRE 300 ohm, heavy duty \$1
- 50'—FLAT 4-CONDUCTOR WIRE many purposes \$1
- 20—ASSORTED TV KNOBS ESCUTCHEONS etc. \$20 value \$1
- 6—ASSORTED STANDARD TUNER UHF STRIPS \$1
- 10—ASSORTED STANDARD TUNER VHF STRIPS \$1
- 100—ASST. CERAMIC CONDENSERS some in 5% \$1
- 2—TV VERTICAL OUTPUT TRANSFORMERS 18 to 1 ratio \$1
- 20—ASSORTED GRID CAPS for 1B3, 1X2, 6BG6, 6BQ6, etc. \$1
- 20—WIREWOUND RESISTORS 15K—10 watts \$1
- 20—WIREWOUND RESISTORS 40 ohms—10 watts \$1
- 2—RATIO DETECTOR COILS 4.5mc or 10.7mc \$1
- 2—TV SOUND I.F. COILS 4.5mc or 21.2mc \$1
- 2—SOUND DISCRIMINATOR COILS 4.5mc or 10.7mc \$1
- 50—ASSORTED TV PEAKING COILS all popular types \$1
- 4—ASST. TV ION TRAPS for all type TV Receivers \$1
- 10—TV PICTURE TUBE SOCKETS wired with 20" leads \$1
- 5—TV HI-VOLT ANODE LEADS 20" length \$1
- 10—DIODE CRYSTALS 1N34 \$1
- 10—ASST. DIODE CRYSTALS 5—1N60 and 5—1N64 \$1
- 3—SILICON RECTIFIERS Top Hat 500ma-400 PIV \$1
- 50'—INSULATED SHIELDED WIRE #20 braided metal jacket \$1
- 32'—TEST PROD WIRE deluxe quality, red or black \$1
- 50'—HI-VOLTAGE WIRE for TV, special circuits, etc. \$1
- STANDARD BRAND TUBES 024, 1B3, 1X2, 5U4, 5Y3, 6AC7, 6AU6, 6AX4, 6BQ6, 6CG7, 6I6, 6K6, 6SN7, 6U8, 6X8, 12AT7, 12AU7, 12AX4, 50C5, 50L6 Each Tube \$1

MARKET SCOOP COLUMN

- 100—PRECISION RESISTORS \$1
asst. list price \$50.00 less 98%
- 2—IBM COMPUTER SECTIONS \$1
loaded with valuable parts
- 3—IBM 25L6 TUBES \$1
- 1000—ASST. HARDWARE KIT \$1
screws, nuts, washers, rivets, etc.
- 1000—SOLID BRASS SCREWS \$1
#2/56, 3/8" long, flat head
- 1000—BLACK NICKEL SCREWS \$1
#6/40, 1/2" long, flister head
- 100'—STANDARD ZIP CORD \$1
2 conductor #18 white or brown
- 100'—MINIATURE ZIP CORD \$1
2 conductor, serves 101 uses
- 50—G.E. FLASHLIGHT BULBS \$1
#PR-9, 2.7 volts, 15A
- 50—PILOT LIGHT SOCKETS \$1
bayonet type, wired
- 20—BALL POINT PENS \$1
Retractable, assorted colors
- 10—BALL POINT PEN FILLERS \$1
black fineline for drafting and offset, fits 95% of all pens made
- 1—HEARING AID AMPLIFIER \$1
incl 3 Tubes, Mike, Etc. (as is)
- 1—CHAPT ZU DI MITZIA \$1
"JACKPOT" double your money back if not entirely satisfied
- 3—3" RECORDER TAPES \$1
quality acetate, 150 feet
- 10—3" RECORDER TAPE REELS \$1
- 1—SQ. YARD GRILLE CLOTH \$1
most popular brown & gold design
- 500'—CHOICE HOOKUP WIRE \$1
asst colors cut in handy lengths some stripped and tinned
- 100—ASST TUBULAR CONDENSERS .001 to .47 to 600v \$1
- 100—RADIO & TV SOCKETS \$1
asst 7 pin, 8 pin and 9 pin
- 100—ASSORTED FUSES \$1
3AG and other popular sizes
- 300—CERAMIC CONDENSERS Erie, tubular, 300 mmf—500v \$1
- 10—ASSORTED TUBES \$1
Radio, Television and Industrial
- 20—RCA #954 TUBES \$1
- 10—RCA #12L8 TUBES \$1
- 3—STANDARD 35W4 TUBES \$1
- 3—STANDARD 12AT6 TUBES \$1
- 5—RCA #1U4 TUBES \$1
also serves as a 1T4 Tube
- COMMODORE 5-TUBE RADIO \$6
AC-DC, complete ready to play
- GLOBAL 6-TRANSISTOR RADIO Complete ready to play \$9
- GLOBAL 9-TRANSISTOR RADIO Complete ready to play \$14

HANDY WAY TO ORDER—Simply pencil mark items wanted in squares and enclose with money order or check—You will receive a new copy of these Offers for re-orders. **ON SMALL ORDERS**—Include stamps for postage, excess refunded—**LARGER ORDERS** shipped express charges collect **SAME DAY DELIVERY** . . . **SCIENTIFIC PACKING** for minimum shipping cost.
FACTORY OR JOBBER CLOSE-OUTS WANTED. If you have the merchandise, we have the cash—No quantity too large. Phone or write today. Cash waiting

BROOKS RADIO & TV CORP., 84 Vesey St., Dept. A, New York 7, N.Y.

TELEPHONE Cortland 7-2359

Superior's New Model 820

TUBE TESTER



**TESTS ALL MODERN TUBES
INCLUDING THE NEW**

- ✓ NOVARS
- ✓ NUVISTORS
- ✓ 10 PINS
- ✓ 12 PIN
COMPACTRONS

- Employs new improved emission circuit.
- Tests over 850 tube types.
- Tests OZ4 and other gas filled tubes.
- Employs new 4" meter with sealed air-damping chamber resulting in accurate vibrationless readings.
- Use of 26 sockets permits testing all popular tube types.
- Dual Scale meter permits testing of low current tubes.
- 7 and 9 pin straighteners mounted on panel.
- All sections of multi-element tubes tested simultaneously.
- Ultra-sensitive leakage test circuit will indicate leakage up to 5 megohms.

Model 820 comes complete with tube charts and instructions; housed in handsome, portable, Saddle-Stitched Texon case. Only **\$3850**

**SHIPPED ON APPROVAL
NO MONEY WITH ORDER — NO C. O. D.**

Try it for 15 days before you buy. If completely satisfied then send \$5.00 and pay balance at rate of \$5.00 per month until total price of \$38.50 (plus postage) is paid — No Interest or Finance Charges Added! If not completely satisfied, return to us, no explanation necessary.

MOSS ELECTRONIC, INC.
DEPT. D-861, 3849 Tenth Ave., New York 34, N.Y.
Please rush Model 820. If satisfactory, I will pay on terms specified. Otherwise I will return tester.

Name _____
Address _____
City _____ Zone _____ State _____
All prices net, F.O.B., N.Y.C.

**"Messenger" CB Transceivers...rated
BEST in Nation by Electronic
Distributor Salesmen***



*New impartial survey by leading electronic magazine shows Johnson "Messenger" Transceivers rated "BEST"—BEST BY NEARLY 50% OVER SECOND CHOICE BRAND.

**4 feature-packed "Messengers"... and
Selective Call System outperform everything!**

Compact, Hand-Held—100 milliwatt or 1 watt "Personal Messengers". Rugged and reliable—11 transistors, 4 diodes! Twice the sensitivity and 40% more range than similar units with conventional circuitry—more output than similar units with same rated inputs!

Mobile or Base Stations—performance proved Viking "Messenger" and new "Messenger Two". Punches your signal across the miles—high efficiency design makes full use of maximum legal power. Excellent receiver sensitivity and selectivity. Automatic "squench" control—5 or 10 channel coverage—easy to install anywhere!

Tone Alert—37 tone selective call system mutes speakers until one unit calls another—then automatically your stations receive audio note and indicator light flashes "On".



**NEW! 4-color
BROCHURE—write
for your free copy!**



Manufacturers of the world's most widely used personal communications transmitters.



E. F. JOHNSON CO.

2502 10th Ave. S.W., Waseca, Minnesota

Please rush "Messenger" details to:

NAME _____
ADDRESS _____
CITY _____ STATE _____

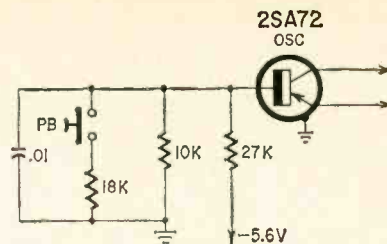

the oscillator base circuit. When it is depressed, it adds an 18,000-ohm resistor in parallel with the oscillator's 10,000-ohm base resistor. As long as the batteries are good, depressing the button has no effect. But when the batteries are weak, the oscillator stops and the radio does not operate, indicating it is time for new batteries. Trying this on other sets might give you a chance to recommend fresh batteries.

—Warren Roy

Muntz/Standard Coil

A Muntz set with a Standard Coil cascode tuner (6BQ7 and 6J6) lost channels 2, 4 and 5. All the others came in fine. Antenna and lead-in checked OK. No opens, no obvious troubles.

Replacing the 6BQ7 cured the trouble. It seems that it is tougher to get the lower channels through the tuner than the higher ones. A weak tube can often kill performance.—N. B. Brubaker

Disturbance Test Transistor Radio

Simply connect one end of a 100,000-ohm resistor to the ungrounded side of the radio's battery. Touch the free end to the base of each transistor in turn from output back to input. If the stage and all following stages are good, you'll

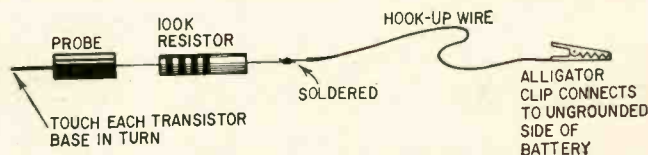

hear a click. If not, you know where to look for the trouble.

If you get clicks all the way back to the antenna, but the set still won't work, the local oscillator is probably not working. Check for rf across its tank with a vtm and an rf probe.—E. L. Deschambault

Norelco Continental 400 Recorder

Slow rewind on these machines can be cured by making the felt disc beneath the right hand turntable the same diameter as the left one. This will increase the clutch action between drive wheel and turntable.

Incidentally, the erase head on this machine is susceptible to damage from many commercial head cleaners. The safest and simplest way to clean the head is to use alcohol or methylated spirits applied with Q-Tips. Use one end of the tip to apply cleaner and the other to polish the head bright.—David A. Hall

"Grip Cream" Cures Phono Slippage

The usual way to repair slipping phonograph motors and drives is to replace drive wheels, idler wheels, etc. There are times, though, when replacement does not cure the slipping. Neither does increasing spring tension, even if adjustments are possible. Then, too, in many cases the proper size wheels may not be available.

A simple and effective cure for this slippage is to go to the nearest bowling alley and buy a small jar of "grip cream". This is a preparation used by many bowlers to help them get a firmer grip and better control of their bowling ball. Apply a small amount of this grip cream to all rubber parts of the drive and idler wheels. *Caution:* use this cream very

sparingly! If too much is applied, it can cause the wheels to stick together enough so that the motor will not start.

After this cream is applied, run the phono motor for a while to distribute an even coating on all parts. Set the motor and drive assembly aside for a day, and then try it once more. The motor should start readily. If not, too much of the cream has been applied.

This grip cream can also be used on slipping dial drive cords, and other devices, to increase friction.—*Bernhardt J. Litke*

Emerson 844 Portable Radio

This transistor radio motorboated badly, but installing a new triple-section filter capacitor did not help. Extra filtering made some difference, but did not eliminate the trouble.

I finally solved the puzzler by putting in separate single-unit capacitors instead of the multiple one used originally. The audio driver bypass shared the same can with the power filter, and coupling between sections caused feedback and motorboating.—*Charles Andrews*

Philco H-1716, H-1814, H-1816 phonos

These stereo phonographs use two 6BQ5's in push-pull for each channel. The four 6BQ5 cathodes have a common 75-ohm bias resistor. They fail rather often, but a simple

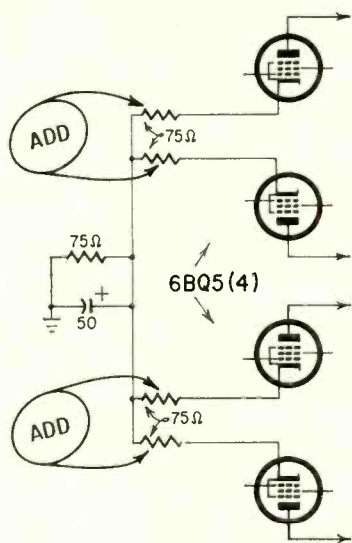

modification extends their life. Add individual resistors to supply partial bias as shown. The resistors are not critical—any standard value from 56 to 82 ohms, 1/2 watt, will do.—*A. von Zook*

Screen Resistor and Width Trouble

Most TV sets obtain the screen voltage for the horizontal output tube through a dropping resistor from the B-plus supply. A decrease in the value of the screen resistor increases the width because of the increased voltage on the screen. But in cases where the screen resistor is connected to the boosted B-plus, the problem is different.

In several sets where the complaint was insufficient width, with low voltage readings at the boosted B-plus points, the screen voltage still measured normal. After many hours of wasted time, the value of the screen resistor was checked and was about 3,000 ohms low. Replacing the screen resistor raised the boosted B-plus and cured the width troubles. The screen voltage still did not increase.—*George P. Oberto*

RCA 7-BT-9, 7-BT-10

The type 235 transistor used as the converter in these transistor sets is no longer available. As a replacement, use the 2N212. When the 235 is replaced with a 2N212, realign the radio for maximum performances.—*W. C. Warren* END

master mathematics at home

learn more...learn faster...learn better through bona fide programmed learning

BASIC MATHEMATICS • WHOLE NUMBERS AND NUMERALS • ALGEBRA I • ALGEBRA II • PLANE GEOMETRY • SOLID GEOMETRY • THE LANGUAGE OF ALGEBRA • TRIGONOMETRY • ANALYTIC TRIGONOMETRY • INTRODUCTORY CALCULUS I & II • MANAGEMENT DECISION MAKING • VERBAL PROBLEMS • INTRODUCTION TO SETS, INEQUALITIES AND FUNCTIONS • DESCRIPTIVE STATISTICS

exclusive with

Britannica Schools

A MEMBER OF THE ENCYCLOPAEDIA BRITANNICA FAMILY

These 14 courses—developed by a group of skilled, carefully trained specialists in the fields of home study and mathematics—are offered by Britannica Schools in Programmed Learning format together with individualized, home-study guidance.

What is Programmed Learning? Considered by many educators as the finest way to teach mathematics that has been discovered, Programmed Learning is the technique used in teaching machines. Programmed Learning course material is presented in small, sequential segments, or "frames," each containing 1) a single piece of information closely related to the information preceding it; 2) a question to test your understanding of the information; and 3) a masked, correct answer. When you are ready to check your response to a frame, you simply move the mask. Thus, you proceed systematically through the course, frame by frame, at the pace best suited to yourself.

What is Britannica Schools? A division of world-famous Encyclopaedia Britannica family, Britannica Schools is the first new approach to learning at home in 50 years, because it is the first, and, to date, the only home study institution that offers courses utilizing Programmed Learning techniques. As a Britannica Schools enrollee, you also have your own, individual instructor who—through phased examinations and correspondence—reviews your progress, checks your grasp and retention of sections of the course material, and insures your complete mastery of the subject.

For full details on any Britannica Schools course in mathematics, fill out and send us the coupon, today. No obligation. SOLD ONLY THROUGH THE MAIL.

BRITANNICA SCHOOLS Dept. RE-1
Division of Encyclopaedia Britannica Press, Inc.
14 East Jackson Boulevard, Chicago 4, Illinois

Please send me full details on the course(s) I have checked. I understand there is no obligation.

- | | |
|---|---|
| <input type="checkbox"/> Basic Mathematics | <input type="checkbox"/> Analytic Trigonometry |
| <input type="checkbox"/> Whole Numbers And Numerals | <input type="checkbox"/> Introductory Calculus I & II |
| <input type="checkbox"/> Algebra I | <input type="checkbox"/> Management Decision Making |
| <input type="checkbox"/> Algebra II | <input type="checkbox"/> Verbal Problems |
| <input type="checkbox"/> Plane Geometry | <input type="checkbox"/> Introduction To Sets, Inequalities And Functions |
| <input type="checkbox"/> Solid Geometry | <input type="checkbox"/> Descriptive Statistics |
| <input type="checkbox"/> The Language Of Algebra | |
| <input type="checkbox"/> Trigonometry | |

Name _____
Address _____
City _____ Zone _____ State _____
Age _____ Occupation _____

1962-63 TV Replacements Lead Stancor's

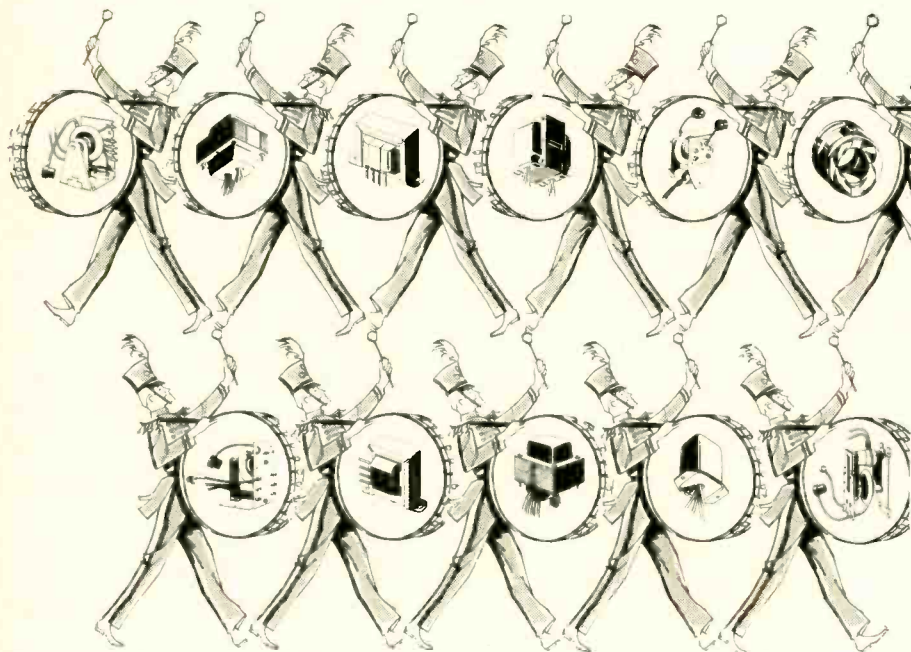

PARADE OF PARTS

Stancor exact replacement transformers for 1962 and 1963 television sets are *now* available from your distributor. For the first time in the history of the transformer replacement market, parts are in stock for sets the dealers are selling today. These brand-new units are among the more than 90 yokes, flybacks, powers, and vertical output transformers added to the Stancor line so far this year.

This 1963 Stancor Parade of Parts dramatizes our continuing program of providing an exact replacement transformer for your every need, available through your electronic parts distributor.

You can rely on him . . . and on

STANCOR
ELECTRONICS, INC.
3501F W. Addison, Chicago 18, Ill.

Q.

Where can you buy modern, handsomely clothbound books on servicing, test instruments, shop practice and electronic theory for less than 67 cents?

A.

ON PAGE 79.

TECHNICIANS'

NEWS

New NARDA Chapter

An Ohio chapter of the National Appliance & Radio-TV Dealers Association, consisting of some 200 members, has been established, according to Jules Steinberg, NARDA executive vice president.

President of the Ohio chapter, which includes members from several previously established local chapters in the state, is Charles D. Grove, of Alliance, Ohio.

A second meeting is scheduled for late June.

TESA Miami Officers

Miami—Apparently well satisfied with his first one-year term as president, TESA Miami re-elected Sam Kessler to head the organization for another year. Retained as first vice president (also a second term) is Robert Seymour. Other officers: second vice president, Julio Sera; recording secretary, Jack Norris; corresponding secretary, Daniel Prowler; treasurer (fifth term), Charles W. Minter.

Alameda County TRA

Alameda, Calif.—Allan D. Crawford of El Cerrito succeeded Lewis E. Hall as president of the Alameda County Television & Radio Association. Hall is ACTRA's delegate to the California State Electronics Association Council.

Other officers include John A. Edwards, first vice president; Norman W. James, Berkeley, second vice president; Fred W. Rock, San Leandro, secretary, and William R. Howard, San Leandro, treasurer.

Tri-City TSA Elects

Seattle—This year's officers of the Tri-City TV Service Association include Dick Hunt, president; Jim Davis, vice president; Jim May, secretary; and Oscar Schornhorst, treasurer. Trustees are Wes Stordahl, Carl Dubois and Mylo Candee.

New NATESA Affiliate In Quincy, Ill.

A NATESA Charter was presented to TESA-Quincy (Illinois) recently, by Lyle Green, East Central vice president of NATESA. Vincent J. Lutz, TESA-St. Louis NATESA director and past NATESA president, and Sam Maksimuk, NATESA director from Chicago-TESA, spoke at the meeting.

Harold W. Hillerts is president of the Quincy group, and William R. Morrison is NATESA director.

School of Service

Indianapolis—The Indiana Electronic Service Association and the Television Service Association of Ohio will sponsor jointly the 1963 School of Service Business Management. The sessions will be held June 4 and 5 at the Hotel Van Orman, Fort Wayne, Ind.

The school is intended for the one-, two- or three-man shop—backbones of the service industry. Participating shops are being asked to send in actual profit-and-loss statements for 1962, so that instructors and students can work with real figures and convincing examples.

Also sought is information about unusual business features—advertising methods, rental programs, contract service programs, trade-in deals, and any other successful procedure worth sharing.

Licensing Closer in Indiana?

Indianapolis—TV service licensing in Indiana came closer to reality early this year. On one day, between 120 and 150 service technicians from all over the state poured into the State Capitol to speak their minds about licensing. Of them, 60 testified before a (State) House Judiciary Committee public hearing in favor of the measure. Not one person at the hearing spoke against the bill.

"Licensing of the TV service industry by the State of Indiana is preferred by 9 out of 10 of the people actually engaged in doing service work in this state," said Jay R. Schupbach of Fort Wayne. His authority was a mail survey made last fall in an attempt to feel out attitudes to licensing.

Licensing Around the Nation

Harrisburg, Pa.—The Pennsylvania Federation of Television & Radio Service Associations has called for state-wide support from all parts of the industry to bring about passage of a licensing bill. The measure would create a state board of examiners of radio and TV service technicians.

Hartford, Conn.—A proposed bill that would require a state license for TV repairmen was considered at a hearing before the general law committee at the State Capitol recently. There was little opposition.

Under the proposal, an examining board for the trade would be established and the present necessity of obtaining licenses in the individual towns would be eliminated.

Sacramento, Calif.—While it is not strictly a licensing move, California legislators are proposing a controlling restriction: any person removing a TV or radio from the owner's home must give

*a selection
of 7 quality
microphones
for natural,
life-like
tape
recordings*



SONOTONE CERAMIKES

Whether you're a professional or a home recordist, there's a Sonotone "Ceramide"® to bring out the best in your tape recording equipment. So sensitive they pick up all the beauty of the original performance — so selective they screen out unwelcome intrusions — so rugged they withstand almost any abuse, even accidental dropping, and continue to provide topflight performance. The heart of every Ceramide is a rugged rubber-encased ceramic transducer — immune to extremes of temperature and humidity.

7 sonotone ceramikes for tape recording

SONOTONE CERAMIKE "CMT-10A" MATCHED TWINS. Ideal for stereo applications. Each set is a selected matched pair exhibiting similar coloration, frequency response and output characteristics to within ± 2 db. Frequency response: 50 to 11,000 cps. Sensitivity: -56 db ± 2 db. 7' shielded cable and phone plug. List \$35.50 per pair.

SONOTONE CERAMIKE "CMT-11A" MATCHED TWINS. Where greater sensitivity is desired. Same specifications as CMT-10A except—Frequency response: 80 to 9000 cps. Sensitivity: -53 db ± 2 db. List \$35.50 per pair.

SONOTONE CERAMIKE "CM-10A." Natural clean reproduction over the full audible range—50 to 11,000 cps. Sensitivity: -56 db ± 2 db. 7' shielded cable with phone plug. List \$17.50.

SONOTONE CERAMIKE "CM-11A." Where greater sensitivity is desired. Same specifications as CM-10A except—Frequency response: 80 to 9000 cps. Sensitivity: 53 db ± 2 db. List \$17.50.

MATCHING TABLE STANDS. Available with $\frac{1}{8}$ " No. 27 thread for floor stand mounting. List \$5.00.

SONOTONE CERAMIKE "CM-32." Ideal low cost microphone for tape recording. Frequency response: 80 to 9500 cps. Sensitivity: -53 db ± 2 db. Standard plug and phone jack. List \$12.50.

SONOTONE CERAMIKES "CM-40" & "CM-41." Low price ceramic mikes in high impact plastic case. Unique swing type stand sits upright for table use. Response: 40 to 8000 cps. Sensitivity -50 db for both models. Model CM-41 has push-to-talk switch. CM-40 List \$9.90; CM-41 List \$11.90.

Next time you're ready for a tape recording session, think of Sonotone Ceramikes and select the one that will bring greater pleasure to you.



SONOTONE® CORPORATION

ELECTRONIC APPLICATIONS DIVISION • ELMSFORD, N. Y.

In Canada: Atlas Radio Corp., Ltd., Toronto • Cartridges • Speakers • Tape Heads • Microphones • Electron Tubes • Batteries • Hearing Aids • Headphones

BUY DELUXE CLOTHBOUND

GERNSBACK LIBRARY BOOKS

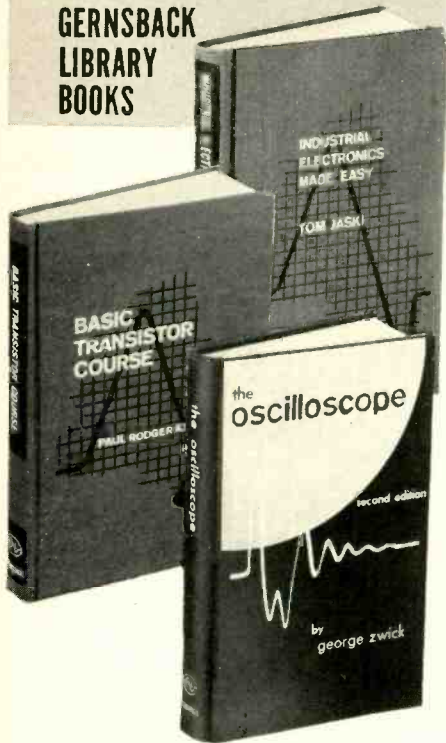

3 little steps you can take by learning and earning with Gernsback Library books. Deluxe hard covered, fully illustrated, written to be understood.

THE OSCILLOSCOPE (revised edition)
How to use the scope in AM, FM and TV, tests and measurements. Make your scope work hard. Study waveforms, alignment, tests, measurements. Full chapter on scope experiments.

BASIC TRANSISTOR COURSE
Sure-fire way to learn transistors. Characteristics, audio amplifiers, detectors, AGC, i.f. amplifiers, front ends, types, circuit analysis.

INDUSTRIAL ELECTRONICS MADE EASY
What industrial equipment is, how it works. Chapters on generators, counters, maintenance, interference, control, switches, recording, transducers, tools.

 **THE PIONEER ELECTRONICS PUBLISHER**

----- 10 DAY EXAMINATION -----
REMITTANCE MUST ACCOMPANY ORDER

GERNSBACK LIBRARY INC. 63ARE
154 W. 14th St., New York 11, N. Y.

Enclosed is \$..... Please send me.
 ___ BASIC TRANSISTOR COURSE \$5.75
 ___ THE OSCILLOSCOPE \$5.20
 ___ INDUSTRIAL ELECTRONICS MADE EASY \$5.95

NAME.....
 ADDRESS.....
 CITY..... STATE.....

the owner a receipt including an estimate of total charges.

The estimate would be binding, too—the repairman would have no lien on the set when the actual charges exceed either the original estimate or a written revision, dated and signed by the set owner.

Springfield, Ill.—A bill to license radio and TV repairmen (the Electronic Service Act) has been introduced in the Illinois Legislature.

A technician would have to serve for 3 years as an apprentice before applying for a license. An advanced electronic technician would meet the same requirements and could also service color TV sets. Licenses would be in effect for 1 year and be subject to renewal.

Uhf Station Tour

Cincinnati—About 75 technicians from the greater Cincinnati area participated recently in a tour of uhf TV station WCET (Channel 48, Cincinnati). The trip was arranged by TESA.

Following a tour of the station's facilities, Bert Neely, general manager of WCET, spoke about the station's history and about some of its early financial problems. The educational TV outlet's school programs are doing well now—some 50,000 school children each week watch the shows in classrooms.

Ted Milligin, WCET program manager, spoke about adult-interest programs and pointed out the increasing market for uhf converters in the area.

Al Mirus, TESA director, discussed uhf converters, antennas and antenna installation. Bill Weller of Blonder-Tongue was there also, displaying some of his company's uhf products.

RCA Gives TV Course with Tubes

Harrison, N.J.—Harold Stamm, manager of advertising and sales promotion of RCA's Electron Tube Div., announced that RCA is making available an eight-lesson course free of charge with the purchase of RCA entertainment tubes. The course, part of RCA's Project IV program, is called a Color TV Home Study Course. END

CB Jamboree

Four Citizens-band clubs in Iowa and South Dakota are getting together for the "Sioux Empire Jamboree", June 22 and 23, at Lewis and Clark Lake, Yankton, S.D.

The participating clubs are Tri-State Flea-Waters, Inc. of Sioux City, Iowa; Little Sioux Radio Club, Cherokee, Iowa; Sioux Valley Radio Club, Smithland, Iowa, and S.E.C.C.A. of Sioux Falls, S.D. They'll be standing by on channels 9 and 11 at the Jamboree site.

PARTS

+ SERVICE +

FOR ALL

GERMAN

RADIOS-PHONOGRAPHS
TAPE RECORDERS

EUROTECH SERVICE CO.
66-44 FOREST AVENUE
BROOKLYN 27, N.Y. HY 7-1448

Convert any television to sensitive, **BIG-SCREEN OSCILLOSCOPE** with minor, inexpensive changes. Ingenious circuit. No electronic experience needed to follow our clearly illustrated plans. **TECHNICIANS, HAMS, EXPERIMENTERS, BROADCASTERS.** Use in shop, school, lab. Any set—any size screen.

FULL PLANS \$2.
RELCO, Dept. RE-6, Box 10563, Houston 18, Tex.

RADIO RESEARCH INSTRUMENT CO.
AUTO-TRACK & TELEMETRY ANTENNA PEDESTALS
3 & 10 CM. SCR. 584 AUTOTRACK RADARS.
AN/TPS-10 SEARCH. AN/TPS-10 HT. FINDERS.
AN/PPN-32GCA. AN/APS-10 NAVIG. & WEATHER.
AN/APS-15B PRECISION. AN/APS-35B PRECISION.
AN/APS-31A SEARCH. DOZENS MORE.
.5-1.2 MEGAWATT HIGH POWER PULSERS.

RADIO RESEARCH INSTRUMENT CO.
550 Fifth Ave., New York Judson 6-4891

RADAR SYSTEMS & COMPONENTS/ IMMEDIATE DELIVERY

FREE Catalog
OF THE WORLD'S FINEST
ELECTRONIC GOV'T
SURPLUS BARGAINS

 HUNDREDS OF TOP QUALITY ITEMS— Receivers, Transmitters, Microphones, Inverters, Power Supplies, Meters, Phones, Antennas, Indicators, Filters, Transformers, Amplifiers, Headsets, Converters, Control Boxes, Dynamotors, Test Equipment, Motors, Blowers, Cable, Kevers, Chokes, Handsets, Switches, etc., etc. Send for Free Catalog—Dept. RE.

FAIR RADIO SALES
2133 ELIDA RD. • Box 1105 • LIMA, OHIO

You may have a Respiratory Disease. Don't take chances.

**COUGH TOO MUCH?
SHORT OF BREATH?**

✚ See your doctor, says your Christmas Seal organization.

Fix Electric Appliances That **DON'T WORK**
PAYS \$3 TO \$5 PER HOUR

FREE BOOK tells about profitable spare-time or full-time business. 400 MILLION Appliances now in use. People need them fixed. YOU make good money doing it—right at home! Easy course trains you for top earnings. At no extra charge you get Appliance Tester. Get FREE Book. FREE Sample Lesson! Mail coupon now.

NATIONAL RADIO INSTITUTE, Appliance Division
Dept. FF5, Washington 16, D.C.

Send Free Book, Free Appliance Repair Course Lesson.

Name.....
 Address.....
 City..... Zone..... State.....



Unbreakable Plug Handle

One accidental step on the bakelite handle of a phone plug and you have a nice mess of broken bakelite to sweep up. When this accident happens—don't



fret. Just slip a plastic test-clip insulator over the plug. It will make a snug fit and work very well, at least until you can attach a new plug.—*John A. Comstock*

Easy-in, Easy-out tubes:

A tube or two in a chassis often just refuses to leave its socket easily. They have frozen in the sockets because of oxidation on the tube pins.

Whenever we come across one of these stubborn tubes, we struggle to get them out, just like everyone else. But then we coat the tube pins with a thin layer of white petroleum jelly. On tubes with key-way bases, we coat the key too. We do this on every tube we remove for testing as well as every new tube we use for replacement. In the future they will be *easy in* and *easy out*. Don't forget the picture tube. A hard-to-get-off socket can loosen the base from the neck of these tubes.

The thin coating of petroleum jelly will not cause leakage or other trouble.—*George E. Molson*

Miniature Solder Pot

Some heating elements of pencil type soldering irons are easily converted into a solder pot for small-pin plugs. Enlarge the tapped hole for the tiplets to accommodate the pin to be soldered. Mount the element in a miniature candle-base socket flush-mounted on a stabilizing base of large enough diameter or sufficient weight to prevent tipping. The size of the solder pot allows close work to be handled and, if the work is accidentally knocked over, there



The most Famous Name in
TOWERS of ALL KINDS!

Here are the advantages you get
when you insist on **ROHN TOWERS**

LARGEST FULL RANGE OF TOWERS—you can get anything from home TV and amateur radio towers to heavy-duty communication and micro-wave towers. Included are 170 foot self-supporting towers, 1,000 foot guyed towers, and "fold-over" towers. Regardless of your needs, ROHN can supply it.

UNQUESTIONED LEADERSHIP IN DESIGN AND MANUFACTURE—you get the latest in advanced tower engineering. All communication towers are engineered to EIA specifications, and are proved by thousands of installations. No other manufacturer can surpass the quality and fine reputation of ROHN.

QUALITY MATERIALS AND WORKMANSHIP—Only highest quality steel is used which fully meets the specifications for the job. ROHN towers are hot-dipped galvanized after fabrication—a feature ROHN pioneered!

SERVICE WHEREVER YOU WANT IT—ROHN representatives are world-wide. Complete erection service for communication systems, broadcasting, micro-wave, and other needs is available; also competent engineering service to help you.

Settle for the BEST in TOWERS—ROHN—today the world's largest, exclusive manufacturer of towers of all kinds!

For your needs, contact your local ROHN salesman, distributor or dealer; or write direct for information.

SEND THE HANDY COUPON INDICATING YOUR NEEDS

ROHN
Manufacturing
Company
BOX 2000
PEORIA, ILLINOIS

ROHN Manufacturing Company
Box 2000
Peoria, Illinois

Send me complete literature on the following ROHN Products:

- | | |
|---|--|
| <input type="checkbox"/> Home TV Towers | <input type="checkbox"/> Amateur Towers |
| <input type="checkbox"/> Communication Towers | <input type="checkbox"/> AM-FM Broadcasting Towers |
| <input type="checkbox"/> Micro-Wave Towers | <input type="checkbox"/> Government |

Name _____
Firm _____
Address _____
City _____ State _____

MERCURY TV TUNER SERVICE

890-2 River Ave., Bronx 51, N.Y.

"Largest in the East"

VHF-UHF TUNERS

1 Year Warranty
Price Includes All Parts Except Tubes

ALL MAKES
ONE PRICE!

\$9.50

When Shipping Tuner: Include Tubes,
Shields and Damaged Parts.

Give Model Number and State Complaint

PACK WELL AND INSURE
24 HOURS ON POPULAR TYPES

CORNELL

33¢ PER TUBE

100 TUBES OR MORE:
30¢ PER TUBE

1 YR. GUARANTEED
Mutual Conductance Lab-tested, Individually
Boxed, Branded and Code Dated

RADIO & TV TUBES

OZ4	6AU4	6CG7	6Q7	7A7	12BF6
1B3	6AU5	6CG8	6S4	7B6	12BH7
1L4	6AU6	6CM7	6SA7	7B8	12BL6
1T4	6AU8	6CX8	6SC7	7C5	12BQ6
1U4	6AV6	6CZ5	6SH7	7Y4	12BY7
1X2	6AW8	6D6	6SJ7	12AD6	12C5
2A5	6AX4	6DA4	6SK7	12AE6	12CA5
3CB6	6BA6				12DQ6
3Q5	6BC5				12SN7
5U4	6BD6				12SQ7
5V4	6BG6				25L6
5Y3	6BH6				25Z6
5Z3	6BJ6				35W4
6A6	6BL7				35Y4
6A8	6BN4				35Z5
6AB4	6BN6	6DE6	6SL7	12AF6	50L6
6AC7	6BQ6	6DQ6	6SN7	12AT7	117Z6
6AG5	6BQ7	6F6	6S07	12AU7	27
6AL5	6BX7	6H6	6U8	12AX4	41
6AN8	6BZ6	6J5	6V6	12AX7	45
6AQ5	6C4	6J6	6W4	12B4	47
6AS5	6CB6	6K6	6W6	12BA6	75
6AT6	6CD6	6K7	6X4	12BD6	80
6AT8	6CF6	6L6	6X5	12BE6	84/6Z4

If not shipped in 24 hrs
YOUR ORDER FREE!

Other tubes and CRT's at low prices—send for free list

LIVE IN THE EAST?
WAITED MONTHS FOR DELIVERY FROM OTHERS?
AIR MAIL AN ORDER TO CORNELL
AND RECEIVE DELIVERY TO THE EAST COAST
IN AS LITTLE AS 72 HOURS!!!
NO SUBSTITUTIONS WITHOUT YOUR PERMISSION
Tubes are new, seconds or used and so marked.

TERMS: All Pre-Paid Orders over \$5.00 postage free. Under \$5.00 add 50¢ for handling. Send 25% Deposit on all COD orders. Canadian and Foreign orders, send approximate postage. All orders subject to prior sale. 5-DAY MONEY BACK OFFER!

CORNELL ELECTRONICS CO.
Dept. RE6 4217 University Ave., San Diego 5, Calif. • Phone: AT 1-9792

NEW! LAFAYETTE
13-TRANSISTOR 2-WAY
"WALKIE TALKIE" WITH SQUELCH
only **39.95** 2 for **78.88**



More fun... better performance... greater value, than ever. Superb for fishing, hunting or business use. No age restrictions or license requirements when used as per Part 15 FCC regulations. Features: separate microphone and speaker for better sending and receiving, excellent noise squelch; crystal controlled receive and transmit, positive action push-to-talk switch and 46" telescoping antenna. As a bonus feature, the HE-100 may be operated in the home with an AC power pack. (Optional see below) Saves batteries too! Includes crystals, earphone, leather carrying case and batteries.

ies. Shpg. wt., 22 oz. Imported
HE-100L Walkie-Talkie Net 39.95
Pair for 78.88

NEW! AC POWER PACK
Converts 117VAC to 9V DC.
Plugs into HE-100.
HE-97 Net 7.45

ORDER A PAIR TODAY!

LAFAYETTE Radio ELECTRONICS
Dept. JF-3, P.O. Box 1F3
Syosset, L. I., N. Y.

Send me: Walkie Talkie (HE-100L)
AC Power Pack (HE-97),
Shipping charges collect. \$ enclosed.

Name.....
Address.....
City..... Zone..... State.....

NO FREE premiums
NO PRIVATE labels
NO ineffective liquids
or carbon tet
ALL YOU GET IS
GENUINE
"NO NOISE"
QUALITY

- formulas developed by chemists
- 14 years of recognized leadership

BEWARE OF
CHEAP
IMITATIONS
INSIST ON
NO-NOISE



- VOLUME CONTROL and Contact Restorer
- TUNER-TONIC for all tuners including wafer type
- FORMULA EC-44 for all electrical contacts

PLUS FREE with all No-Noise products, 5" plastic extender push-button assembly for pin-point applications. Does not cause shorts!

ELECTRONIC CHEMICAL CORP.

813 Communipaw Avenue Jersey City 4, N. J.

Radio-Electronics

TELL YOUR FRIENDS ABOUT



is little solder to be spilled. Heating is fast, and this eliminates the need for continuous operation of the solder pot.
—E. C. Carlson

Organ Tuning by Telephone

Whether you're a technician doing a tonal touchup for a customer after repair work or an experimenter finishing your home-built organ, here are some hints that should help.

Simply use as a standard another organ that is in tune. "Great" (or "Swell"), you're probably thinking, "but who has an extra instrument to use just for tuning?" Well, do you have a friend who owns an electronic organ—or one who works in a dealer's showroom? When you're ready for final tuning, call your friend and have him send you the notes by phone.

Adjust each out-of-tune note for zero beat with the same note from the standard. Use simple flute tones without vibrato and you'll find it's easy to hear beats (much easier than with a piano, where the notes are not sustained).

The sophisticated technician will probably want to use his scope as an indicator, feeding the vertical input from one organ and the horizontal from the other. When the scope shows a single line, circle or ellipse, the two notes are exactly the same pitch. (Your scope instruction book will give details on making such frequency comparisons.) Don't worry about distortion—it's just a stationary pattern you're after on the scope. A high-output microphone against your telephone receiver may work directly into the scope's vertical input without a preamp. Your friend's telephone, of course, just needs to be placed near his instrument's speaker.

Another hint—read the manufacturer's instructions before you do any random rotating of tuning screws. There may be interaction that will remind you of trying to align a superhet with a flexible rubber screwdriver!—
Hugh Lineback

END

NEW LITERATURE

CATALOGS • BOOKLETS • CHARTS

MICROMINIATURE CONNECTORS described in 24-page *Catalog MM-1*. Contains data on *Mighty Mite Series 222* for cable-to-cable or cable-to-chassis applications. *Micro-Edge Series 64* printed circuit/wiring receptacles, many others. Specs. performance characteristics, suggested applications on all series. Many photos, line drawings.—**Amphenol-Borg Electronics Corp.**, Amphenol Connector Div., 1830 S. 54 Ave., Chicago, Ill.

MIKES AND ACCESSORIES offered in 6-page *1963 Product Directory*. Covers broadcast and professional mikes: PA units; advanced amateur recording, industrial sound, mobile radio, language lab and general-purpose mikes. Photos and specs on all items.—**American Microphone Co.**, 1st & George Sts., Galien, Mich.

SEMICONDUCTOR BARGAINS offered in 4-page 11 x 17-in. foldup leaflet. Capacitors, resistors, transformers, plus transistor radios, tuning meters, phono jacks, etc.—**Poly-Paks Co.**, P.O. Box 942, So. Lynnfield, Mass.

PORABLE TAPE RECORDERS. 24-page booklet describes manufacturer's models 550 and 660, with photos and full specs. Tells about selection and use of mikes, recording tricks, maintenance and operating hints. Suggests 25 ways to use a portable tape recorder.—**Citroen Electronics Corp.**, 729 N. Highland Ave., Los Angeles 38, Calif. 50¢.

MICROWAVE ANTENNAS offered in 20-page catalog. Photos and specs on antennas operating from 806 mc to 12 gc; microwave antennas for special applications; manufacturer's line of feeds, mounts, radomes, control and thermostat kits. Many new products.—**Jerrold-Faco**, 15 & Lehigh Ave., Philadelphia 32, Pa.

BARRY'S GREEN SHEET No. 10, Spring 1963 Catalog. 48-page illustrated catalog features new and surplus tubes, semiconductors, transformers, chokes, meters, test equipment, industrial supplies.—**Barry Electronics Corp.**, 512 Broadway, New York 12, N. Y. 15¢.

TV DISTRIBUTION EQUIPMENT displayed in 5 data sheets. Photos, charts, block diagrams and specs on master antenna system Yagis; high-output, broad-band amplifiers; new Ultra-Tap all-purpose tap-off unit.—**Jerrold Electronics Corp.**, 15 & Lehigh Ave., Philadelphia 32, Pa.

PERMANENT MAGNETS outlined in 40-page *Brochure PM-200*. Sections on theory, characteristics, design and application; discussion of types of magnetic materials; glossary of magnet terms and symbols. Features Alnico and Lodex demagnetization and energy curves, dc magnetization curves and listing of magnetic and physical properties of various magnetic materials.—**General Electric Co.**, Schenectady 5, N. Y.

CAPACITOR SELECTOR CHARTS. Two 17 x 22-in. wall charts, one for aluminum, one for niobium/tantalum electrolytics, with major electrical and mechanical characteristics. Aluminum electrolytic charts shows 20 case styles, 12 mathematical capacitor equations for design calculations. Niobium/tantalum chart has true-size drawings of form factors; table lists multipliers for calculating derating factors at varied temperatures and frequencies.—**Cornell-Dubilier Electronics Div.**, Federal Pacific Electric Co., 50 Paris St., Newark, N. J.

ELECTRONIC TEST/MEASURING INSTRUMENTS. 100-page, illustrated catalog features sweeping oscillators, audio spectrum analyzers, noise generators, attenuators, oscillators, etc. Many photos, complete specs. Cross-indexed by product name, category, page no.—**Kay Electric Co.**, Maple Ave., Dept. R-E, Pinebrook, N. J.

MICROWAVE DEVICES described in 8-page brochure. Offers traveling-wave tubes, backward-

wave oscillators and microwave phototubes with photos, characteristic charts and specs.—**Sylvania Electric Products Inc.**, 1100 Main St., Buffalo, N. Y.

HI-FI/TEST KITS. *Listening and Testing*, 23-page brochure, offers photos and specs on 12 stereo hi-fi kits, 21 test equipment kits.—**Paco Electronics Co., Inc.**, 70-31 84 St., Glendale 27, N. Y.

ANTENNA DISTRIBUTION detailed in *Fact-Finder 232*. 16-page illustrated manual. Covers layout, installation of large and small systems. Tells how to figure system losses, how to select equipment, includes glossary of terms. Separate layout sheet may be filled in by reader and sent to manufacturer for recommendations.—**Winegard Sales Dept.**, 3000 Kirkwood Ave., Burlington, Iowa.

SALE CATALOG, No. 225. Radios, phonos, tape recorders, stereo equipment, CB transceivers, electronic components shown in illustrated 86-page catalog. Items on sale until June 30, 1963.—**Allied Radio**, 100 N. Western Ave., Chicago, Ill.

KLIP-SEL VOLTAGE-SURGE PROTECTION MANUAL, No. KL-601. 20-page booklet gives data on protection of silicon rectifier diodes, transistors, silicon controlled rectifiers, other semiconductors, with selenium transient voltage suppressors.—**International Rectifier Corp.**, El Segundo, Calif.

MINIATURE TRIMMING POTENTIOMETERS, Series 310, 312, 313, 316, 318 described in separate data sheets. Ranges 10-100,000 ohms, operating temperature ranges -55° to +150°C. Actual-size photos, electrical, mechanical, environmental specs, modification possibilities, engineering drawings, power rating curve, circuit diagrams.—**Weston Instruments & Electronics Div.**, 614 Frelinghuysen Ave., Newark 14, N. J.

MICROELECTRONIC SOLDERING IRONS shown in 2-page *Form 1210*. Specs and construction details, full-size drawings of irons for micro-miniature soldering. Also shows 13 spare tips, cleaning sponge, soldering kit.—**Hexacon Electric Co.**, 161 W. Clay Ave., Roselle Park, N. J.

BATTERY HOLDERS. 8-page illustrated catalog describes aluminum and steel holders for commercial and government use, plus accessories. Includes description of materials, military specs, dimensional drawings, custom-built variations.—**Keystone Electronics Corp.**, 49 Bleecker St., New York 12, N. Y.

MIKE EXTENSION KIT described in catalog sheet. For use with Ampli-Vox Roving Rostrum PA system.—**Perma-Power Co.**, 3100 N. Elston Ave., Chicago 18, Ill.

TUBING CATALOG, No. AT 63. 20 pages include 12-page section on shrinkable tubing products—polyvinylchloride and semi-rigid tubing, wire markers, wire termination caps—comparative applications and properties charts, illustrated description of irradiated tubing theory. Also contains data on manufacturer's standard insulated tubing.—**Alpha Wire Corp.**, 200 Varick St., New York 14, N. Y.

STACK-SWITCH COMPONENTS AND ASSEMBLIES shown in illustrated. 8-page *Catalog S-308*. Features new general-purpose stack switches made of actuator spring and various contact springs. Illustrates components for computers, telephone relays, micro-miniature switching, other control devices, lists stack-switch component kits.—**Switchcraft, Inc.**, 5555 N. Elston Ave., Chicago 30. END

Any or all of these catalogs, bulletins, or periodicals are available to you on request direct to the manufacturers' whose addresses are listed at the end of each item. Use your letterhead—do not use postcards. To facilitate identification, mention the issue and page of RADIO-ELECTRONICS on which the item appears. UNLESS OTHERWISE STATED, ALL ITEMS ARE GRATIS. ALL LITERATURE OFFERS ARE VOID AFTER SIX MONTHS.

NEW SAMS BOOKS

ABC's of Electronic Drafting

Electronic drafting is a specialty, involving the use of a particular form of "shorthand" to represent electronic circuits on paper. This valuable book explains and describes electronic drafting in all its phases: Component symbols, schematic diagrams, pictorial drawings, and block diagrams. Shows how to prepare plans and sketches, and how to detail assembly, installation, and circuit wiring of all types of electronic equipment. 96 pages; \$1.95 5 1/2 x 8 1/2". Order **DRA-1**, only.

Electronics Communications Dictionary

by the *Sams Engineering Staff*. An all-new, authoritative reference work for broadcast engineers, hams, CB'ers and telephone engineers. Includes over 2500 words, terms, phrases, abbreviations, and idioms relating specifically to the art of electronics communications. Provides complete and meaningful definitions of all terms used in the electronics communications vocabulary; helpfully cross-indexed; most complete reference work on the subject. \$3.95 160 pages; 5 1/2 x 8 1/2". Order **COM-1**, only.

Auto Radio Servicing Made Easy

by *Wayne Lemons*. Written by the "serviceman's serviceman" to help you easily solve your auto radio repair problems. Makes you master of the step-by-step methods required for localizing auto radio troubles in just minutes. Chapters cover: Antenna and Antenna-Input Circuits; RF-Amplifier Circuits; Converter or Mixer-Oscillator Circuits; Audio Driver Circuits; Audio Output Circuits; Power Supplies; Search or Signal-Seeking Tuners; Troubleshooting & Repair; Troubleshooting All-Transistor Radios; Noise & Installation Problems. 128 \$2.95 pages; 5 1/2 x 8 1/2". Order **ARL-1**, only.

Elements of Transistor Technology

by *Robert G. Middleton*. Now—a book that goes beyond "armchair" theory to provide the practical facts actually required in the laboratory or at the workbench. Covers solid-state technology from basic diodes to the most advanced transistors in use today, in easy-to-understand language. Details the electrical and physical properties of various transistor designs, their construction, circuit design and operation, performance characteristics, etc. Provides practical data on equivalent circuits, feedback, distortion, stabilization, gain, leakage, etc. Ideal classroom or self-study text. 288 pages; \$6.95 5 1/2 x 8 1/2"; hardbound. Order **SEM-1**, only.

Design and Operation of Digital Computers

by *G. Haas*. Fully answers the growing need for information on digital computers which are rapidly increasing in use in the fields of data processing, automatic machine control, language translation, etc. Thoroughly details the fundamentals of digital computer circuits, with special emphasis on the use of transistors in modern logical circuits, counters, and storage and register circuits. A sound introduction to the study of electronic digital computer circuits. 288 pages; 5 1/2 x 8 1/2"; hardbound. Order **DIG-1**, only.

Intermodulation and Harmonic Distortion Handbook

by *Howard W. Tremaine*. Single-frequency tests of a device often fail to give a true picture of the distortion characteristics. Intermodulation distortion tests, on the other hand, more nearly approximate the characteristics of the human ear. Here, finally, is full information on the theory of harmonic and intermodulation distortion generation, and the methods for measuring it. Describes various types of intermodulation analyzers, including the design, construction, and calibration of an analyzer developed by the author. Thoroughly explains measurement techniques for numerous input, output, and special test circuits. Essential to everyone in \$3.95 audio. 160 pages; 5 1/2 x 8 1/2". Order **INT-1**, only.

Scope Waveform Analysis

by *Robert G. Middleton*. Knowing how an oscilloscope works is one thing, but even more important is knowing how to use it, and especially how to properly obtain waveforms and interpret what they mean. This book, by the "dean" of test equipment writers, does just that. It covers: Oscilloscope Trace Analysis; Basic Waveform Characteristics; Waveshaping Principles and Analysis; Waveform Types and Aspects; Waveform Measurements. Invaluable for technicians, engineers, experimenters and students. 160 pages; 5 1/2 x 8 1/2". Order **SWM-1**, only.

HOWARD W. SAMS & CO., INC.

Order from your Sams Distributor today, or mail to Howard W. Sams & Co., Inc., Dept. F-23 4300 W. 62nd Street, Indianapolis 6, Ind.

Send me the following books:

DRA-1 ARL-1 DIG-1 SWM-1
 COM-1 SEM-1 INT-1

\$_____ enclosed. Send FREE Booklist

Name _____

Address _____

City _____ Zone _____ State _____

IN CANADA: A. C. Simmonds & Sons, Ltd., Toronto 7

COYNE
TRAINS YOU
IN SPARE TIME
AT HOME

COYNE QUALITY TRAINING AT LOWEST COST

TELEVISION

COLOR TV-RADIO-ELECTRONICS

Only from famous COYNE do you get this modern up-to-the minute TV Home Training. Easy to follow instructions—fully illustrated with 2150 photos and diagrams. Not an old Radio Course with Television tacked on. Includes UHF and COLOR TV. Personal guidance by Coyne Staff. *Practical Job Guides* to help you **EARN MONEY QUICKLY IN A TV-RADIO SALES AND SERVICE BUSINESS—part time or full time.** COSTS MUCH LESS—pay only for training—no costly "put together kits."

SEND TODAY FOR FREE BOOK

SEND COUPON or write to address below for *Free Book* and full details including EASY PAYMENT PLAN. NO COST OR OBLIGATION—NO SALESMAN WILL CALL.



B. W. COOKE
 Pres.

COYNE
ELECTRICAL SCHOOL

FOUNDED 1899

CHARTERED AS AN EDUCATIONAL INSTITUTION NOT FOR PROFIT
 1501 W. Congress Pkwy. Dept. A3-H2 Chicago 7, Ill.

COYNE Television Home Training Div.
 New Coyne Building, Dept. A3-H2,
 1501 W. Congress Pkwy., Chicago 7, Ill.

Send FREE BOOK and details of your Television Home Training offer.

Name _____
 Address _____
 City _____ State _____

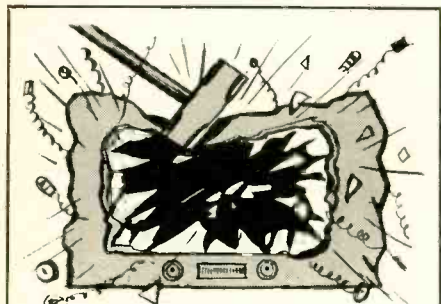

STOP!

WRECKING YOUR TV...

Inrush surge currents at 'Turn-On' destroy more TUBES, RECTIFIERS, and CAPACITORS than all other causes.

EFFECTIVE, AUTOMATIC REDUCTION of the punishing inrush currents is immediately provided by the...

WUERTH SURGISTOR®



- No. 4100-2 100-275 watts, 117 v. \$1.95 List
- No. 8050-4 250-400 watts, 117 v. 2.95 List
- No. 8035-5 300-500 watts, 117 v. 3.30 List

Use SURGISTORS with your TV, Hi-Fi, Film Projector, or any device requiring inrush surge current protection. SEE your distributor or dealer TODAY. Or, send order direct to us for prompt action.

WUERTH PRODUCTS CORP.

1931 Moffet St. Hollywood, Florida

NEW SEMI-CONDUCTORS & TUBES

Plastic transistors

A new, low-cost, highly reliable "plastic" transistor has been announced by G-E. Hermetic sealing is provided by a quartzlike layer formed over the silicon base pellet during manufacture. The outer epoxy shell is for protection only.

The new transistors come in a wide

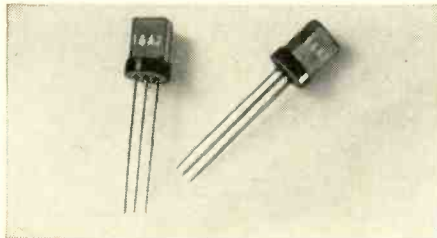

variety of types. The 2N2711 and -12 are typical. Intended for standard broadcast rf, converter and i.f. work, they have ac betas of 55 and 169, respectively.

SC-3557 CRT

This is a high-brightness cathode-ray tube designed for military aircraft. Definitely one of the more compact CRT's, it measures only 5 7/8 inches long.



Neck diameter is less than 1 inch, and screen diameter is 3 inches.

The high brightness is obtained with anode voltages up to 17,500. Grid 1's cutoff ranges between -33 and -77 volts. It's made by Sylvania.

8149, 8150

These tubes, identical except for mechanical structure (and hence also interelectrode capacitance) are rf beam pentodes in compactron envelopes, with 12-pin button bases. Both are made by Tung-Sol.

The 8149 is single-ended (base pins only). The 8150 is double-ended (has plate cap). Both tubes have an ICAS plate dissipation of 35 watts maximum, and can produce 40 watts rf (class C) up to 175 mc.

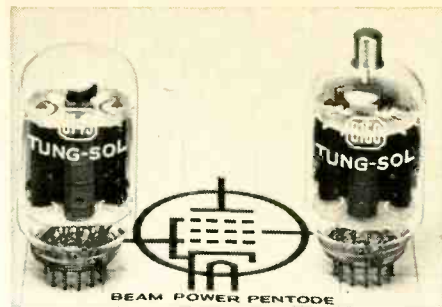

Both feature a center-tapped heater for 3-cell or 6-cell operation (nominal 6 and 12 volts).

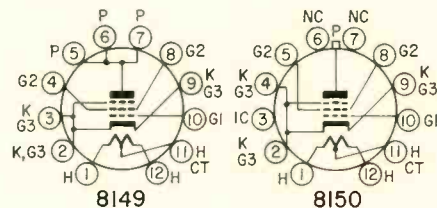

Typical operation as class-C amplifier at 175 mc:

E_{bb}	380 volts
E_{g2} from E_{bb} through	1000 ohms
E_{g1}	-78 volts
E_{a1g} (peak)	120 volts
I_{bb}	180 ma
I_{g2}	12 ma
Driving power	2 watts
Output power	40 watts

END

Correction

There is a mathematical error in the third line, third column of the article "Watch out for Transients" on page 28 of the April issue.

In converting rms voltage to the equivalent peak value, the author inadvertently used 1.77 instead of 1.41 as the conversion factor. Thus 400 volts rms equals 564, not 708, peak volts.

Our thanks to Thomas C. LaRoy of Dearborn, Mich., for reporting this rather obvious error.



"Loss of brightness could mean most anything, Swami."

NOTEWORTHY CIRCUITS

Vlf Receiver Detects Atomic Blasts

Charged particles from a nuclear blast or a rocket motor generate low-frequency radio signals that can be detected at great distances. Similarly, thunderstorms and other atmospheric disturbances can be detected and tracked from afar. Fig. 1 shows a simple receiver that will detect missiles, atomic explosions and thunderstorms, and enable the operator to differentiate between them.

The receiver, described in *Radio Constructor* (London, England), covers

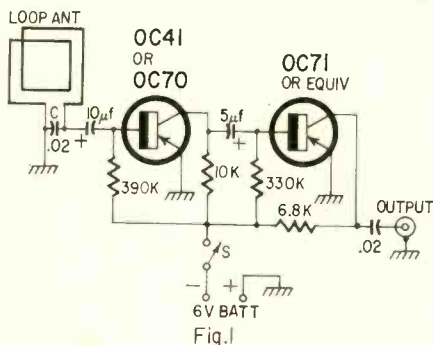

from 4 to 5 kc. It feeds into high-impedance phones, recorder or scope. On a scope, thunderstorms appear as peaks of rising amplitude varying with distance and energy. A rocket causes a single signal of longer duration with a much sharper and more pronounced apex. A second stage firing at higher altitude produces noise bursts as vertical traces on the scope. You can learn to recognize various types of activity by recording and logging the signals as they occur and then checking papers for news of storms and rocket and atomic tests.

The loop antenna consists of 220 turns of No. 24 enameled wire wound around a framework consisting of two crossed 1 x 1 x 48-inch spars fastened together at right angles. Each end is capped with a 1/2 x 1/4 x 2-inch strip glued across it. (Fig. 2). The ends of the loop are brought to a terminal strip and bridged with a .02- μ f fixed tuning capacitor (C). The lead-in is not critical but must be kept away from power lines to prevent hum pickup.

To tune the loop, couple an audio signal generator to the loop terminals

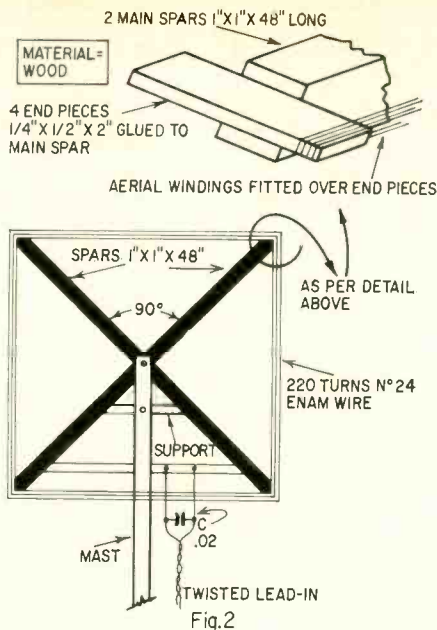

and a scope or vtvm across the receiver's output. Adjust the loop's turns or tuning capacitor for maximum response in the range of 4 to 5 kc.

Simple Capacitance Measurement

If you don't own a bridge or capacitance meter, you still can measure capacitance accurately and quickly with your vom (set to its 100- μ a dc range) and square-wave generator. The only extras needed are a 1N34-A diode and a 16,000-ohm carbon resistor. The diagram shows the setup.

The method is so simple that only a demonstration will convince a skeptic of its excellence. Capacitances are read directly on the 1-100- μ a scale. Response is linear, so no corrections or curves are needed. The square-wave output must be not less than 13.5 volts peak to peak, and the resistor must be as close to 16,000 ohms as possible. Only four frequencies are used (100

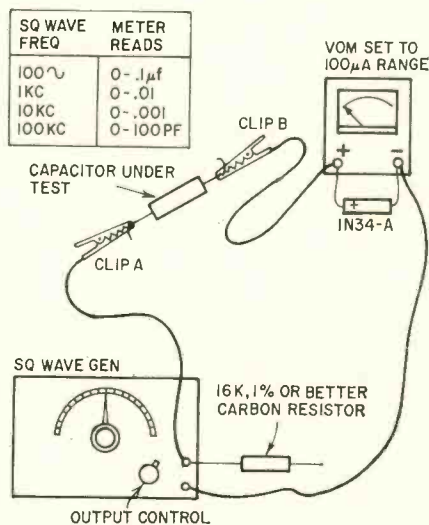

TRANSISTORIZED POWER CONVERTER

12 VOLT DC to 117 VOLT AC

FOR \$29.95 DEALER NET ONLY

POWERFUL 125 WATT CONTINUOUS DUTY. PROVIDES 117 VOLT 60 CYCLE AC BY PLUGGING INTO CAR OR BOAT 12 VOLT CIGARETTE LIGHTER RECEPTACLE.



ASK YOUR ELECTRONIC PARTS DISTRIBUTOR FOR

TRANSVERTER

Designed and Manufactured by:

WORKMAN Electronic PRODUCTS, INC.
SARASOTA, FLORIDA

FREE OFFER FROM

SEMITRON

10 SILICON RECTIFIERS*
PLUS FREE TV HIGH VOLTAGE TESTER



- * New ratings 850MA, 500PIV
- * New exclusive Thermal Jacket Heat Sink (pat. pend.)

BOTH FOR ONLY \$695

- SERVICE-ENGINEERED to replace all existing rectifiers in TV, radio and hi-fi, up to 850MA, 500PIV
- Provides improved thermal dissipation for increased life and reliability
- Helps you eliminate TV callbacks, prevent breakdown due to excessive heat.

FREE TV HV TESTER: checks RF pulses, high voltage transformers, and tracks horizontal amplifier and oscillator circuits.

See your local distributor or send your order to:
SEMITRONICS CORP., 265 Canal St., N. Y. 13, N. Y.

Enclosed is check (M.O.) for \$6.95. Send me, post-paid, my kit of 10 Silicon Rectifiers plus FREE TV High Voltage Tester.

Name _____
Address _____
City _____ State _____
My Electronic Distributor is _____

ONLY \$9.95 EACH



FUN-TO-BUILD knight-kit

WALKIE-TALKIE

C-100 ALL-TRANSISTOR 2-WAY TRANSCEIVER KIT

Now! Enjoy real on-the-go communication between two or more stations up to 1/4 mile! Just press the button and you're "on-the-air." No license or exam required, no age limit. Operates up to 75 hours on low-cost battery. Handsome blue case, only 5 3/8 x 2 7/8 x 1 3/4"; telescoping 40" antenna. A breeze to build. Includes all parts, solder, easy wiring instructions (less battery). Wt., 9 ozs.

83 Y 804ET. Walkie-Talkie Kit. \$9.95 Each only

83 Y 013. Leatherette Carrying Case. \$9.84

83 Y 002. 9-Volt Battery. \$2.14

SILICON TOP HATS OR DIODES **750 MA** **LOWEST PRICES GUARANTEED**

LOW LEAKAGE NEWEST TYPE

PIV/RMS 50/35 .05 ea.	PIV/RMS 100/70 .09 ea.	PIV/RMS 200/140 .12 ea.	PIV/RMS 300/210 .18 ea.
PIV/RMS 400/280 .23 ea.	PIV/RMS 500/350 .28 ea.	PIV/RMS 600/420 .38 ea.	PIV/RMS 700/490 .50 ea.
PIV/RMS 800/560 .58 ea.	PIV/RMS 900/630 .68 ea.	PIV/RMS 1000/700 .78 ea.	PIV/RMS 1100/770 .88 ea.

ALL TESTS! AC & DC FVD!
ALSO TESTED ON LOAD

100 Dif. Pre. Res. 1/2, 1, 2 WATT-1% Tol. \$1.25
G.E. IN91 Diode-10 for \$1.00, 100 for \$8.00
Special 8 Amp. 400 V Sil. Stud Rect. 10 for \$9.50

SILICON POWER DIODE STUDS

Amps	Piv	Sale	Amps	Piv	Sale
3	50	\$0.15	35	50	\$1.30
3	100	.30	35	100	1.55
3	200	.40	35	200	2.00
3	400	.65	35	400	3.00
3	600	.75	50	50	2.25
12	50	.60	50	100	3.25
12	100	.80	50	200	4.00
12	200	1.00	100	50	2.75
12	400	1.50	100	100	3.50
12	600	2.00	100	300	4.00

All material guaranteed. \$2.00 min. order. Orders F.O.B. NYC. Include check or money order. Shpg. charges plus. C.O.D. orders 25% down.

WARREN ELECTRONICS CO.
NYC 7, NY 87 Chambers St. WO 2-5727

cycles and 1, 10 and 100 kc), which means that the generator dial may be set permanently to 100 and the frequency range switch rotated to change capacitance ranges.

To use the setup: Set the generator frequency to 100 cycles. Connect clip B to the resistor. Adjust the generator output control for exact full-scale meter deflection. Transfer clip B to the unknown capacitor and read the capacitance from the meter scale. The 100-cycle signal gives a range of 0-0.1 μf. Any capacitor within this range may be connected to clips A and B and its capacitance read directly without any further adjustments. Setting the generator to 1 kc gives a 0-.01-μf range; 10 kc, 0-.001 μf, and 100 kc, 0-.0001 μf (100 pf).

If the capacitance cannot be read accurately, switch to another range, according to the table in the diagram. Each time the range is changed, first connect clip B to the resistor and adjust the generator output for full-scale deflection. Then transfer clip B to the capacitor.

While it is advisable to reset the meter to full scale each time the range is changed, most generators have constant output voltage throughout their tuning range, making repetition of this step unnecessary.

One word of caution: the method will not work satisfactorily with sine waves. The response becomes quite non-linear, so that a special meter scale is required if you *must* use sine waves.—
Rufus P. Turner END

ALLIED RADIO-ORDER TODAY

100 N. Western Ave., Chicago 80, Ill.

Ship me: Walkie-Talkie Kit(s) 83 Y 804ET.
 Carrying Case(s) 83 Y 013
 9 V. Battery(ies) 83 Y 002

\$.....enclosed check money order

Name _____
PLEASE PRINT

Address _____

City _____ Zone _____ State _____

FAST SHIPMENTS

RECORDERS • TAPES

COMPONENTS • KITS

• BEST-BY-COMPARISON PRICES
• FACTORY SEALED CARTONS
• SEND FOR "QUOTES" ON PACKAGE
• DEALS AND SAVE MORE

WRITE FOR MONTHLY SPECIALS

CARSTON Studios
125-R East 88 St., New York 28, N. Y.

SAVE MONEY **HI-FI COMPONENTS**
TAPE RECORDERS
SLEEP LEARN KITS

MERITAPE Low cost, high quality recording tape, in boxes or cans.

FREE 1963 CATALOG

DRESSNER 1523 JERICHO TPKE.
NEW HYDE PARK 17, N.Y.

TOO HIGH?

Mail us your list of components for a Price-Crushing quote on your stereo hi-fi needs!

Write too for our valuable audio discount catalog A-17.

KEY ELECTRONICS CO.
120 Liberty St. New York 6, N. Y.



ELECTRONICS

Engineering-Technicians

Heald's Micro-wave and Radar Laboratory Equipment.

The Nation's increased demand for Engineers, Electronic Technicians, Radio TV Technicians is at an all time high. Heald Graduates are in demand for Preferred High Paying Salaries. Train Now for a lucrative, satisfying lifetime career.

Bachelor of Science Degree, 30 Months
Save Two Years' Time

Radio-Television Plus Color Technician (12 Months)
 Electronics Engineering Technology (15 Months)
 Electronics Engineering (B.S. Degree)
 Electrical Engineering (B.S. Degree)
 Mechanical Engineering (B.S. Degree)
 Civil Engineering (B.S. Degree)
 Architecture (B.S. Degree)

Approved for Veterans
DAY AND EVENING CLASSES

Write for Catalog and Registration Application.
New Term Starting Soon.

Your Name _____
Address _____
City _____
State _____

HEALD'S ENGINEERING COLLEGE
Established 1863
Van Ness at Post, RE
San Francisco, Calif.

50 Years Ago
In Gernsback Publications

HUGO GERNSBACK, Founder

Modern Electrics	1908
Wireless Association of America	1908
Electrical Experimenter	1913
Radio News	1919
Science & Invention	1920
Practical Electrics	1921
Television	1927
Radio-Craft	1929
Short-Wave Craft	1930
Television News	1931

Some larger libraries still have copies of Modern Electrics on file for interested readers.

In June, 1913, The Electrical Experimenter

A Treatise on Wireless Telegraphy (Concluded), by H. Gernsback.

A Curious Electrical Rocker.

How to Construct a Simple 1/4 K.W. Wireless Transformer.

Recent Developments in the Work of the Federal Telegraph Company, by Lee de Forest, Ph.D.

How to Construct an Oscillation Transformer, by S. W. Hector.

new PATENTS

Electronic Watch

Patent No. 3,010,075

Helmut Epperlein, Ersingen, Germany. (Assigned to Hamilton Watch Co., Lancaster, Pa.)

A soft iron bar is used with a balance wheel and hairspring to control this watch. It also contains a transistor blocking oscillator, whose tank consists of two windings over a magnetic core plus distributed capacitance (dotted lines).

The bar is pivoted to swing between the pole pieces, and is restrained by a hairspring. Once set

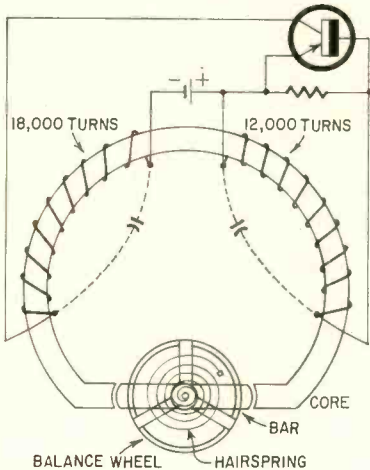

in motion, it tends to oscillate until its energy is dissipated.

Each time the bar approaches its neutral position (shown) it increases coupling between windings. At this instant, the oscillation pulse occurs, magnetizes the core and attracts the bar which, therefore, continues to rotate. This momentary force, applied during each swing at the correct instant, compensates for friction losses and keeps the bar oscillating.

Data Storage

Patent No. 3,023,343

Jack D. Kuchler, San Jose, Calif. (Assigned to Intl. Business Machines Corp.)

This odd-shaped metal tube stores bits of information as magnetism and uses an electron beam to read them out. A, B, C are horizontal portions, and D is vertical. The electron gun at A includes a cathode, grid and anode grounded to the tube. A coil in D generates a downward field to deflect (clockwise) any electrons moving horizontally through it, according to well known physical laws.

Initially, an iron layer at B is magnetized. To record on it, an intense beam from the gun is di-

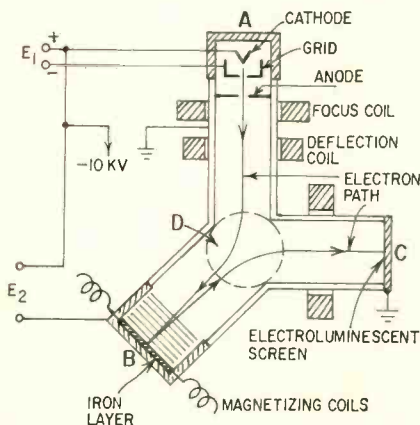

rected to predetermined areas on B. This requires that B have a positive bias from E2.

To read out the information, E2 is made to bias B negative so that approaching electrons come to a stop just before reaching the target. If the target is not magnetized, electrons will be repelled and land on the electroluminescent screen at the end of C, taking the path shown. If magnetization exists, however, it deflects the beam laterally to some extent before the repulsion returns it to C. Therefore the spot where the beam hits the screen indicates whether information has been stored at any particular spot on B.

Tunnel-diode Oscillator

Patent No. 3,041,552

Frank V. Adamthwaite, Jr., North Syracuse, and Chang S. Kim, East Syracuse, N. Y. (Assigned to General Electric Co.)

This circuit claims high efficiency and design flexibility. The crystal controls frequency and also

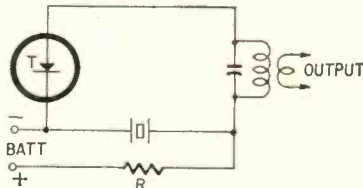

bypasses the power supply, so that all rf appears across the tank. The dc bias is fixed by R in series with the battery.

3-Speaker Stereo

Patent No. 3,050,583

Emmanuel Berlant, Culver City, Calif. (Assigned to Stephens Trusonic, Inc., Culver City)

Stereo effects occur mainly at higher frequencies so there is no real need for two expensive full-range speakers in a stereo system. Here a single full-range speaker is fed monophonically from L + R channels. The tweeters are connected for

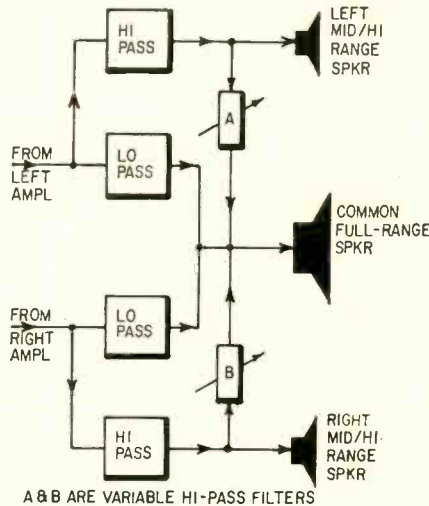

stereo as usual. Some mid-range frequency power comes through the tweeters. Some also passes through adjustable filters to the main speaker.

It is claimed that this approach eliminates the ping-pong effect often noted with binaural and stereo listening. END



"Cash!"

don't let math be a roadblock to a career in ELECTRONICS!

BASIC MATHEMATICS

by Norman H. Crowhurst



4-volume 'pictured-text' course makes it easier than ever before possible to learn all the math you'll need to know to speed your progress in electronics—no short cuts—no gimmicks.

This remarkable 4-volume course takes you in easy stages from counting through algebra, geometry, trigonometry to calculus so that you will understand easily, quickly, all the math you will need to get ahead in electronics—regardless of your previous education! It employs an exciting new technique presenting basic mathematics as one continuous development of mathematics. The individual branches of mathematics are not divided into separate and unrelated subjects. Algebra, geometry, trigonometry, calculus are interwoven at progressively rising levels in the different volumes. Each volume reinforces your understanding as you penetrate more deeply into the subjects. Selected illustrations create clear images of mathematical ideas formerly difficult to understand.

A KNOWLEDGE OF MATH SPEEDS YOUR PROGRESS IN ELECTRONICS—No matter what your plans are in electronics—mathematics plays a vital role. The more math you know, the easier it is to learn electronics. And, if you've set your sights on being an advanced technician or an engineer, this course will speed you towards your goal.

Volume I — ARITHMETIC AS AN OUTGROWTH OF LEARNING TO COUNT — You gain the self-confidence you need to master mathematics! You build a solid foundation in mathematics without realizing that you are being introduced to subjects usually considered dry and difficult to master. #268-1, \$3.90

Volume II — INTRODUCING ALGEBRA, GEOMETRY, TRIGONOMETRY AS WAYS OF THINKING IN MATHEMATICS — Building on the solid foundation laid in Vol. I, you learn to apply algebra, geometry and trigonometry as better methods of solving a problem when the arithmetic begins to get involved. #268-2, \$3.90

Volume III — DEVELOPING ALGEBRA, GEOMETRY, TRIGONOMETRY, CALCULUS AS WORKING METHODS IN MATHEMATICS — This volume continues the search for new and better methods of calculating, and adds calculus to the group of "tools" already introduced. #268-3, \$3.90

Volume IV — DEVELOPING ALGEBRA, GEOMETRY, TRIGONOMETRY, CALCULUS AS ANALYTICAL METHODS IN MATHEMATICS — Once you've reached volume IV, you're ready to apply all that you've learned in the earlier volumes. You'll be able to find the right approach to each individual problem. You'll be ready for a career in which mathematics play a most important part. #268-4, \$3.90

Available at parts distributors, bookstores, or direct.

ORDER TODAY—10-DAY MONEY-BACK GUARANTEE

JOHN F. RIDER PUBLISHER INC.
A Division of Hayden Publishing Co., Inc.
850 Third Avenue, New York 22, N. Y.

Please send me these paperback volumes:
Basic Mathematics Vol. I—\$3.90; Vol. II—\$3.90; Vol. III—\$3.90; Vol. IV—\$3.90; 4 Vol. soft covers \$13.75; Send 4-Vols. in one clothbound edition, \$14.50.

NAME _____
ADDRESS _____
CITY _____ ZONE _____ STATE _____

R-E**Classified****ADS**

Rates—55¢ per word . . . minimum 10 words. Payment must accompany all ads except those placed by accredited advertising agencies. Misleading or objectionable ads not accepted. Copy for August issue must reach us before June 14th. Figure one word: name of city (New York), name of state (New Jersey). Sets of characters as in key (741-RE), also abbreviations as 8x10, 35 mm, A.C., D.C. C.O.D. Hyphenated words not normally considered such count as two words (Hi-Fi). **ZONE NUMBER FREE. RADIO-ELECTRONICS, 154 West 14 St., New York 11, N. Y.**

BUSINESS AIDS

1,000 LETTERHEADS (8½ x 11) \$8.95, 1,000 Envelopes (Size 10) \$9.95, 1,000 Businesscards \$4.95 with name, firm, address, phone. Mail copy and check: **ALLOCCA ENTERPRISES, PO Box 4113, Santa Fe, N.M.** Postage paid.

BUSINESS CARDS, LABELS, RUBBER STAMPS. Send for free descriptive literature, **HEIGHTS INDUSTRIES, 6121 C Street, Capitol Heights 27, Md.**

1,000 Business Cards, "Raised Letters" \$3.75 postpaid. Samples. **ROUTH, RE-6, 3910 Kipling, Greensboro, N. C.**

WANTED

WRITERS! Wanted how-to electronic book manuscripts and other subjects; fiction, nonfiction. **FREE** brochures give tips on writing and publishing. Write Dept. 98-F, **EXPOSITION, 386 Park Avenue So., New York 16, N.Y.**

CASH PAID! Sell your surplus electronic tubes. Want unused, clean radio and TV receiving, transmitting, special purpose, Magnetrans, Klystrons, broadcast types, etc. Want military & commercial lab/test and communications equipment such as G.R., H.P. AN/UPM prefix. Also want commercial receivers and transmitters. For a fair deal write **BARRY, 512 Broadway, New York 12, N.Y. WALKER 5-7000.**

G-R, H-P, L&N, etc., Tubes, manuals, military electronics. **ENGINEERING ASSOCIATES, 434 Patterson Road, Dayton 19, Ohio.**

**EDUCATION/
INSTRUCTION**

HIGHLY EFFECTIVE HOME-STUDY REVIEW for FCC Commercial Phone Exams. Free Literature! **WALLACE COOK, Box 10634, Jackson 9, Miss.**

MAILORDER COURSES. Fantastic discounts. **SELMAR SCIENTIFIC, 14808 N. 30th Drive, Phoenix 23, Ariz.**

LEARN WHILE ASLEEP. Hypnotize with your recorder, phonograph or amazing new Electronic Educator endless tape recorder. Catalog, details free. **SLEEP-LEARNING ASSOCIATION, Box 24-RD, Olympia, Wash.**

NEW CONCEPT OF LEARNING SELF-HYPNOSIS! Now on tape or record! Free Literature. **McKINLEY-SMITH CO., Dept. T5, Box 3038, San Bernardino, Calif.**

FCC LICENSE in 6 weeks, First Class Radio Telephone. Results Guaranteed. **ELKINS RADIO SCHOOL, 2603E Inwood, Dallas, Tex.**

LEARN ELECTRONIC ORGAN SERVICING. New Home Study courses covering all makes electronic organ including transistors. Experimental kits — schematics — troubleshooting. Accredited NHSC-GI Approved. Write for free booklet. **NILES BRYANT SCHOOL, 3631 Stockton Blvd., Dept. F. Sacramento 20, Calif.**

LEARN HYPNOSIS. Free illustrated catalogue. Write: **HYPNOTIST, 8721 Sunset, Los Angeles 69RE, Calif.**

COLLEGE HOME Study Courses from leading universities. Full credit towards Bachelor's or Master's degree. 5,000 course directory \$2.00. **COLLEGE RESEARCH, North Highlands 14, Calif.**

SERVICES

TV TUNERS REBUILT AND ALIGNED per Manufacturer's specifications. Only \$8.50. Guaranteed. We ship COD. **VALLEY TUNERS, 5641-A Cahuenega, No. Hollywood, Calif.**

METERS—MULTIMETERS REPAIRED and calibrated. **BIGELOW ELECTRONICS, Box 71-B, Bluffton, Ohio.**

PATENT SEARCHES, \$6.00! Free "Invention Record"/Information.—**MISS HAYWARD, 1029 Vermont, N.W., Washington 5, D.C.**

TRANSISTORIZED products dealers catalog, \$1. INTERMARKET, CPO 1717, Tokyo, Japan.

ALL MAKES OF ELECTRICAL INSTRUMENTS AND TESTING equipment repaired. HAZELTON INSTRUMENT CO., 128 Liberty St., New York, N.Y.

SPEAKER RECONING. Satisfaction Guaranteed. **C & M RECONO CO., 18 E. Trenton Ave., Morrisville, Pa.**

TV TUNERS REBUILT AND ALIGNED Per manufacturer's specification. Only \$9.50. Any make UHF or VHF. We ship COD. 90-day written guarantee. Ship complete with tubes or write for free mailing kit and dealer brochure. **J. W. ELECTRONICS, Box 51D, Bloomington, Ind.**

FOR SALE**General**

INVESTIGATORS, SECURITY OFFICERS—Professional surveillance and alarm systems. Free Literature. **AMERICAN RECORDING CO., Box 332, Springfield, Va.**

FOR SALE: Electronic Automobile Burglar Alarms, \$10.00 each. ALVIN COTTRELL, Saunemin, Ill.

FREE INSTRUCTION MANUAL with purchase of 10 scale slide rule—\$4.00. Illustrative, Self-Teaching Course—\$2.00. Save! Combination only \$4.95 postpaid. No COD. **ALSYNCO, Dept. RE-3, 171 So. Main, Natick, Mass.**

BEFORE You Buy Receiving Tubes, Test Equipment, Hi-Fi Components, Kits, Parts, etc. . . . send for your Giant Free Zalytron Current Catalog, featuring all STANDARD BRAND TUBES all Brand New Premium Individually Boxed, One Year Guarantee—all at BIGGEST DISCOUNTS in America! We serve professional servicemen, hobbyists, experimenters, engineers, technicians, **WHY PAY MORE? ZALYTRON TUBE CORP., 461 Jericho Turnpike, Mineola, N. Y.**

FREE CATALOG—name-brand tubes 65% discount, phono needles 80% or more discount, phono cartridges, picture tubes 75¢ inch, parts, parts kits, silicon and selenium rectifiers, transmitting tubes, 7" TV test tube \$6.99, imported batteries, tube testers etc. Want to swap or sell tube inventory? Send us your offering. **ARC-TURUS ELECTRONICS CORP.—Dept. R.E., 502 22nd St. Union City, N. J.**

Electronics

PRINTED-CIRCUIT BOARDS, Hams, Experimenters. Garage-Door Opener, January R-E, \$1.50. VOM Amplifier, March R-E, \$1.50. Free Catalog. P/M ELECTRONICS, Box 6288, Seattle 88, Wash.

MOBIL-RADIO SYSTEM. Base station, 9 units, new 120' antenna. \$3500.00. **ROFFERS CHEVROLET SALES, Ashland, Wisc.**

CONVERT any television to sensitive, big-screen oscilloscope. Only minor changes required. No electronic experience necessary. Illustrated plans \$2. **RELCO, Box 10563, Houston 18, Tex.**

RADIO PARTS Earphones, Microphones Testers. UNITA, 545 Fifth Ave., New York 17, N.Y. OX 7-8978.

TROUBLESHOOT FAST! Complete Signal Tracer-Injector. Modify your radio in minutes. Still usable as radio. ISOPROBE kit and Easy instructions. AM kit #121 \$5.95. FM/AM Kit #221 \$7.95. **WALTRONICS, 1814 N. 84th, Milwaukee 13, Wisc.**

SELF-SERVICE CONSOLE TUBE TESTERS. Originally \$149.00. Reconditioned \$19.95. **FOB DELMAR ENGINEERING, 3606 Delmar Rd., Indianapolis 20, Ind.**

DIAGRAMS Radio, Television, \$1.00. SUPREME PUBLICATIONS, 1760 Balsam, Highland Park, Ill.

FREE LITERATURE keeping you informed on the latest work-saving, money-making test equipment. Learn how Easy Budget Payment Plan lets you pay out of increased earnings. Top engineered test instruments are priced for tremendous value. Write today. **CENTURY ELECTRONICS, 352 Maple Ave., Westbury, N.Y.**

TRANS-NITION Electronic Ignition parts kit, Negative ground \$25. Coil, Manual SPECIAL \$8.50. Manual \$2. ANDERSON ENGINEERING, Wrentham, Mass.

GOVERNMENT SURPLUS. Jeeps—\$223.83, Transmitters—\$6.18, Receivers—\$5.65, Typewriters—\$4.15, Oscilloscopes, Multimeters, Speakers, Walkie—Talkies. Typical Government Surplus prices. Exciting details FREE. **N.Y. ENTERPRISES, Box 402-F15, Jamaica 30, N.Y.**

CB TRANSMITTERS \$6.00. Other bargains, send 10¢ for list. **VANGUARD, 190-48—99th Ave., Hollis 23, N.Y.**

RADAR: Largest surplus stock in the world. RADIO RESEARCH INSTRUMENT CO., 550 Fifth Avenue, New York 36, N.Y.

SAVE DOLLARS on radio, TV tubes, parts at less than manufacturer's cost. 100% guaranteed! No

rebrand, pulls. Request Bargain Bulletin. **UNITED RADIO**, 1000-R, Newark, N.J.

DIAGRAMS for TV, \$2.50; for radio, \$1.25. **HIETT DIAGRAMS**, Box 816, Laredo, Tex.

PROFESSIONAL ELECTRONICS PROJECTS—Organs, Timers, Computers, etc.—\$1 each. List free. **PARKS**, Box 1665, Lake City, Seattle 55, Wash.

SUPERSENSITIVE DIRECTIONAL MICROPHONE picks up faint sounds at 300 feet. Detects sound through ordinary walls. Easily built for \$7.00. No electronic experience necessary. Illustrated plans, \$2.00. **DEE CO.**, Box 7263-A, Houston 8, Tex.

DIAGRAMS FOR REPAIRING RADIOS, \$1.25; television \$2.50. Give make, model. **DIAGRAM SERVICE**, Box 672 EI, Hartford 1, Conn.

WALKIE-TALKIE RADIOS: Citizens Band equip; Intercoms; Radio-TV parts. FREE Catalogue. **ALLEN ELECTRONICS**, 41-42C Main, Flushing 55, N.Y.

WEBSTER ELECTRIC INTERCOMS! Amateur Equipment! Marine Electronics! All Select Bargains! 10¢ Any list! **SUPPLIERS**, 187 Miraloma, Miraloma, Calif.

Audio—Hi-fi

CONCERTONE 605-4RK, 505-4RK. One each below cost. **AUDIO**, Box 695, Tarzana, Calif.

TAPE recorders, Hi-Fi components, Sleep-learning equipment, Tapes, Unusual values. Free catalog. **DRESSNER**, 1523 Jericho Turnpike, New Hyde Park 5, N.Y.

RENT STEREO TAPES—over 2,500 different—all major labels—free catalog. **STEREO-PARTI**, 811-RE, Centinela Ave., Inglewood 3, Calif.

SALE ITEMS—tapes—recorders—component quotes. **BAYLA**, Box 131-RE, Wantagh, N. Y.

4/TR STEREO TAPES—bought, sold, rented, traded! Bargain closeouts! Catalog/**COLUMBIA**, 9651 Foxbury, Rivera, Calif.

STEREO TAPES FOR RENT. Write **NATIONAL TAPES**, 71 Dey St., New York 7, N.Y.

HI-FI COMPONENTS, tape recorders at guaranteed "We Will Not Be Undersold" prices. All brands in stock. 15-day money-back guarantee. 2-year warranty. Write your requirements for quotation. No catalog. **HI-FIDELITY CENTER**, 1797D 1st. Ave., New York 28, N.Y.

MISCELLANEOUS

REVERBERATORS for experimental application—\$7.00 postpaid. **CAL's** PO BOX 234, Dearborn, Mich.

LETTERS FROM FABULOUS SCANDINAVIA! Receiving—Forwarding! \$4.00 monthly.—Three for \$1.00! Airmail—Worldwide! Confidentially: **SCAN POOLS**, Box 75, Finspong, Sweden.

EXOTIC EARRINGS! Details free. Pair, \$1.00. **OHGA**, RA-457, Sigakenkusatu, Japan.

\$100 WEEKLY POSSIBLE. Compile mailing lists and address envelopes for advertisers. Home-spare time. Particulars free. **NATIONAL SERVICE**, 81 Knickerbocker Station, New York, N. Y.

MAKE \$25-\$50 WEEK CLIPPING newspaper items for publishers. Some clippings worth \$5.00 each. Particulars free. **NATIONAL**, 81 Knickerbocker Station, New York N. Y.

PRINTING PRESSES, Type, Supplies. Lists 5¢. **TURNBAUGH SERVICE**, Mechanicsburg, Pa.

JUNE, 1963

new BOOKS

A DICTIONARY OF ELECTRONICS, by S. Handel. Penguin Books, Inc., Houghton Mifflin Co., 2 Park St., Boston 7, Mass. 4 1/4 x 7 in., 384 pp. Paper, \$1.65.

A rather complete and up-to-date dictionary, covering the whole field of electronics, as well as physics terms relating to electronics.

MODERN COMMUNICATIONS COURSE, Vol. 2., by Edward M. Noll. Howard W. Sams & Co., Inc., 4300 W. 62 St., Indianapolis, 6, Ind. 5 1/2 x 8 1/2 in., 256 pp. Paper, \$4.95.

Principles and theory of amplitude modulation systems.

MORE ABOUT LOUDSPEAKERS, by G. A. Briggs. Wharfedale Wireless Works, Ltd. Idle, Bradford, Yorkshire, England. 5 1/2 x 8 1/2 in., 136 pp. Paper, \$1.50, Postpaid.

This, the author's third book on the subject of speakers, is devoted largely to points not covered—or not completely covered—in the earlier publications. Will be read by all serious audio enthusiasts.

BASIC THEORY AND APPLICATION OF TUNNEL DIODES, by Sylvester P. Gentile. D. Van Nostrand Co., Inc., 120 Alexander St., Princeton, N. J. 6 x 9 in., 295 pp. Cloth, \$9.00.

A new, nonmathematical treatment on the technician's level of tunnel-diode theory and circuitry. Also describes associated circuit components such as Hall-effect devices and ferrite isolators.

SERVICING TRANSISTORIZED TWO-WAY RADIO, by Patrick M. Craney. Howard W. Sams & Co., Inc., 1720 E. 38 St., Indianapolis 6, Ind. 5 1/2 x 8 1/2 in., 128 pp. Paper, \$2.95.

How to repair and align the latest transmitters and receivers.

RCA TRANSMITTING TUBES, Manual TT-5. Electron Tube Div., RCA, Harrison, N. J. 8 1/4 x 5 1/2 in., 320 pp. Paper, \$1.00.

A companion to the *RCA Receiving Tube Manuals*, this book describes more than 180 types of transmitting and related rectifier tubes.

OVER 11,000 DIRECT TUBE SUBSTITUTES, by H. G. Cisin. Harry G. Cisin, Publisher, Amagansett, N. Y. 5 1/2 x 8 1/2 in. 73 pp. Paper, \$1.25.

There are three important sections: direct substitutes for USA tubes, substitutes for foreign tubes, and picture-tube substitutes for new and old models. A table of military VT equivalents is also given, as well as a short list of transistor replacements.

RADIO AMATEUR'S HANDBOOK, 40th Edition—1963. Headquarters Staff, American Radio Relay League, West Hartford, Conn. 6 1/2 x 9 1/2 in., 751 pp. Paper, \$3.50 in US, \$4.00 in US possessions and Canada, \$5.00 elsewhere.

The radio amateur's technical bible, updated to meet current needs as a construction and reference manual, tube handbook and text for class or home study. In addition to the usual thorough coverage of the theory, design and construction of trans-

NOW! CASTLE OFFERS YOU THE BIGGEST BARGAIN IN TV TUNER OVERHAULING!



ALL MAKES ALL LABOR AND PARTS (EXCEPT TUBES)* 9.95 ONE PRICE
ONE LOW PRICE INCLUDES ALL UHF VHF AND UV COMBINATION* TUNERS

Fast Service . . . Simply send us your defective tuner complete; include tubes, shield cover and any damaged parts with model number and complaint.

*UV combination tuner must be of one piece construction. Separate UHF and VHF tuner with cord or gear drives must be dismantled and the defective unit sent in. 90 Day Warranty.

CASTLE TV TUNER SERVICE, INC.
5715 N. Western Ave., Chicago 45, Illinois
653 Palisade Blvd., Cliffside Park, New Jersey
In Canada: 136 Main St., Toronto 13, Ontario
*Major Parts are additional in Canada

5 CORES
WETS FASTER
MELTS FASTER
Solders Better
WORLD'S FINEST

ERSIN Multicores
5-CORE SOLDER
WORLD'S FINEST

Multicores Sales Corp. Port Washington, N.Y.
For information, write Department MF-383

Easy, Economical, Sure

LEARN ELECTRONICS

with these Low-Cost paperback books



GERNSBACK LIBRARY BASIC SERIES

BASIC RADIO COURSE (revised edition)

G/L #104 Learn radio: electron theory, Ohm's law, resistance, inductance, capacitance, circuits, tubes, transistors, receivers, servicing. A perfect way to start your electronics career.

only
\$4.10

BASIC TV COURSE

G/L #105 Thorough practical discussion of circuit operation. Forming the picture, antennas, tuners, video i.f., detectors, agc, sync, sweep, low- and high-voltage power supplies, portable transistor TV

only
\$4.10

BASIC TRANSISTOR COURSE

G/L #111 A sure-fire way to learn transistor fundamentals. Transistor triodes, characteristics, audio amplifiers, detectors, agc, i.f. amplifiers, front ends, transistor types, circuit analysis.

only
\$4.10

BASIC AUDIO COURSE

G/L #66 Hi-fi from pre-amp to speaker. How and why audio systems work. Fully describes sound measurements, distortion, noise, attenuators, equalizers, speakers, mikes, sound recording.

only
\$2.75

BASIC INDUSTRIAL ELECTRONICS COURSE

G/L #109 The how and why of industrial electronics. Transducers, electronics systems, inspection, sorting, counting, power conversion.

only
\$4.10

BASIC MATH COURSE FOR ELECTRONICS

G/L #100 Gives electronics men a useful working tool in network algebra, math for dc and ac, complex numbers, logarithms.

only
\$4.50

mitters, receivers, modulators, power supplies, antennas and test instruments, special communications modes such as radioteletype and sideband are treated in sufficient detail for the reader to understand the principles, and to build and operate the equipment described.

TV TROUBLESHOOTING AND REPAIR (2nd Edition), by Robert G. Middleton. John F. Rider, Publisher, 116 W. 14 St., New York 11, N. Y. 5 1/2 x 8 1/2 in., 208 pp. Paper, \$3.95.

A complete, well illustrated book, clearly written in Bob Middleton's best style. Aimed at the technician.

PRACTICAL RADIO SERVICING, by William Marcus and Alex Levy. McGraw-Hill Book Co., Inc., 330 West 42nd St., New York 36, N.Y. 6 x 9 in., 624 pp. Cloth, \$11.95.

Starting at the very beginning and proceeding slowly at first, it tells the beginner how and where to look for defects and how to repair home, auto, transistor and FM receivers, as well as phonographs.

MODERN OPERATIONAL CALCULUS, by N. W. McLachlan. Dover Publications, Inc., 180 Varick St., New York 14, N.Y. 5 1/4 x 8 1/2 in., 218 pp. Paper, \$1.75.

A revised edition for physicists and engineers, with examples. Covers linear differential and partial linear differential equations, Laplace transforms. (The author is the McLachlan of the classic book *Loud Speakers*.)

TROUBLE-SHOOTING HIGH-FIDELITY AMPLIFIERS, by Mannie Horowitz. Elgin Press, Inc., New York, N. Y. 6 x 9 in., 127 pp. Paper, \$2.95.

Professional know-how for the technician and advanced kit builder, including troubleshooting, test instruments and measurements.

ELECTRONIC ENGINEERING, by Charles L. Alley and Kenneth W. Atwood. John Wiley & Sons, Inc., 440 Park Ave. S, New York 16, N.Y. 5 3/4 x 9 in., 646 pp. Cloth, \$10.50

Based on class notes for college students, this book discusses tubes, transistors and the circuits using them. Heavy on math.

ABC'S OF RADIOTELEPHONY, by Leo G. Sands. Howard W. Sams & Co., Inc., 4300 W. 62 St., Indianapolis 6, Ind. 5 1/2 x 8 1/2 in., 96 pp. Paper, \$1.95.

An expert discusses AM, FM and SSB for amateurs, Citizens banders and students.

NORTH AMERICAN RADIO-TV STATIONS GUIDE, by Vane A. Jones. Howard W. Sams & Co., Inc., 4300 W. 62 St., Indianapolis 6, Ind. 5 1/2 x 8 1/2 in., 128 pp. Paper, \$1.95.

Lists over 7,500 stations in U.S. and possessions, Canada, Cuba, Mexico and the West Indies. Gives frequency, power, network affiliations, antenna height, stereo-equipped stations. Alphabetical list gives AM, FM and TV stations by call letters; 14 maps show locations of vhf, uhf and FM stations.

PRINCIPLES OF ELECTRON DEVICES, by Angelo C. Gillie. McGraw-Hill Book Co., 330 W 42 St., New York 36, N.Y. 6 x 9 in., 576 pp. Cloth, \$11.50; Paper, \$7.95.

Tubes and transistors are treated here from a practical standpoint, with emphasis on design and calculation.



THE PIONEER ELECTRONICS PUBLISHER

BUY NOW
From Your
ELECTRONICS PARTS DISTRIBUTOR

OR
FILL OUT COUPON

10 DAY EXAMINATION
REMITTANCE MUST ACCOMPANY ORDER 63RE
GERNSBACK LIBRARY INC.
154 W. 14th St., New York 11, N. Y.

Enclosed is \$..... Please send me
— 104 — 105 — 111 — 66 — 109 — 100

NAME.....
ADDRESS.....
CITY..... STATE.....

MOST-OFTEN-NEEDED 1963 TELEVISION SERVICING INFORMATION (Vol. TV-21). Compiled by M. N. Beitman, *Supreme Publications*, 1760 Balsam Rd., Highland Park, Ill. 8 1/2 x 11 in., 192 pp. Paper, \$3.00.

Compilation of complete factory service information including schematics, alignment data, printed-board views, waveforms, voltages and other data covering the very latest TV sets released by all major manufacturers.

SERVICING TRANSISTOR RADIOS (Vols. 17, 18, 19 and 20), Catalog No. TSM-51. Howard W. Sams & Co., 4300 W. 62 St., Indianapolis 6, Ind. 4 volumes, 160 pp. each, 8 1/2 x 11 in. Individual volumes \$2.95, package of 4 \$9.95. Paper.

Compilations of Sams Photofact folders covering 223 current transistor radio

models of 53 different brands.

INTRODUCTION TO NONLINEAR DIFFERENTIAL AND INTEGRAL EQUATIONS, by Harold T. Davis. *Dover Publications, Inc.*, 180 Varick St., New York 14, N.Y. 5 1/2 x 8 1/2 in., 566 pp. Paper, \$2.00.

A comprehensive treatise on analytical methods, with numerous examples, problems and tables.

TUBE AND TRANSISTOR HANDBOOK. Distributed in US by *Continental Dynamics*, PO Box 3125, Beaumont, Tex. 4 1/2 x 8 1/2 in., 504 pp. Flexible cloth, \$3.75.

This special idea in manuals covers American and European tubes and transistors. Directions for its use appear in 10

languages including Arabic.

The desired tube is located in the index, and on the page is found drawn in a typical schematic that gives voltages, currents and other data printed in little "boxes" directly on the tube connections.

82 pages are devoted to transistors.

UNDERSTANDING AMATEUR RADIO, by George Grammer. *American Radio Relay League, West Hartford, Conn.* 6 1/2 x 9 1/2 in., 320 pp. Paper \$2.00 in US, \$2.25 elsewhere.

Latest addition to the ARRL library. Sixteen chapters covering setting up the amateur station, fundamentals of receivers, transmitters, power supplies, antennas, and modulators and how to build them. A must for beginners.

School Directory

GET INTO ELECTRONICS

V.T.I. training leads to success as technicians, field engineers, specialists in communications, guided missiles, computers, radar and automation. Basic & advanced courses in theory & laboratory. Electronic Engineering Technology, an ECPD accredited Technical Institute curriculum. Assoc. degree in 20 mos. B.S. also obtainable. G.I. approved. Graduates in all branches of electronics with major companies. Start Sept., Feb. Dorms, campus. High school graduate or equivalent. Catalog.

VALPARAISO TECHNICAL INSTITUTE
Department C. Valparaiso, Indiana



engineering degree in 27 months

Become an Electronics Engineer. College graduates enjoy higher income... advancement. Major corporations visit us regularly to interview and employ seniors. **BACHELOR OF SCIENCE DEGREE IN 27 MONTHS** in Electrical (Electronics or Special major), Aeronautical, Chemical, Mechanical, Civil Engineering. **IN 36 MONTHS** a B.S. Degree in Business Administration. One-year Drafting-Design Certificate Program. Small classes. Well-equipped labs. Campus. Dorms. new library. *Moderate Costs.* Enter Sept., Jan., Mar., June. Founded 1884. Write J. G. McCarthy for Catalog and "Your Career in Engineering and Commerce" Book.



TRI-STATE COLLEGE

2463 College Avenue • Angola, Ind.



ENGINEERING EDUCATION for the Space Age

NORTHROP INSTITUTE OF TECHNOLOGY is a privately endowed, nonprofit college of engineering offering a complete Bachelor of Science Degree Program and **TWO-YEAR** accredited technical institute curricula. Students from 30 states, many foreign countries. Outstanding successful graduates. Write J. G. McCarthy for Catalog—no obligation.

NORTHROP INSTITUTE OF TECHNOLOGY
1181 West Arbor Vitae Street, Inglewood 1, California

ENGINEERING B.S. DEGREE SCIENCE MATH IN 36 MOS.

U.S. NEEDS 50,000 NEW ENGINEERS A YEAR! EARN ACCREDITED B.S. DEGREE in Science or Engineering in 36 months—year-round program optional. 27-month engineering diploma also available. Classes start June, Sept., Jan., March. **QUALITY EDUCATION.** Graduates employed throughout the U. S. and abroad. Government approved for veteran training. Students from 50 states, 40 countries. 20 buildings; dorms, gym, Campus. New library and laboratories. Employment help provided. **SAVE TIME AND MONEY.** Write for catalog
1616 E. Washington Boulevard, Fort Wayne 2, Indiana

Indiana Institute of Technology
formerly Indiana Technical College

JUNE, 1963

ETI Engineering Technician
A.S. Degree—2 Years
Electronics Engineer
B.S. Degree
Evening Courses Available
ELECTRONIC TECHNICAL INSTITUTE
970 W. Manchester Ave., Inglewood, Calif.
4863 El Cajon Blvd., San Diego, Calif.

ENGINEERING DEGREES
Electronics, Mechanical, Also in Liberal Arts & Major in Accounting earned by
HOME STUDY
Resident Classes Also Available if Desired
Specially course preferred
PACIFIC INTERNATIONAL COLLEGE OF ARTS & SCIENCES
Primarily a correspondence school
Chartered 1935
5719-M Santa Monica Blvd. Hollywood 38, Calif.

How to use electronics as a springboard to success

A man with electronics know-how can have an outstanding career in industry!

Whether you want to become an expert in your present specialty, or you have set your eyes on a high-paying managerial spot, business wants you. And I. C. S. offers 249 courses to help you!

Technical courses cover everything from electronics fundamentals to ultrasonics. Professional radio and electronics training kits available. Business courses cover marketing, production, sales, writing. Send coupon for the free I. C. S. Success Kit: 3 valuable booklets that tell what I. C. S. can do for you!

INTERNATIONAL CORRESPONDENCE SCHOOLS
Box U8753E Scranton 15, Pa.
Please rush me FREE Success Kit. My field of interest is:

Electrical Engineering Business Administration
 Ind. Electronics Engrg. Personnel Management
 Prac. Radio & TV Engrg. Sales
 Other technical course Other business course

(list other course) _____

Name _____ Age _____
Address _____
City _____ Zone _____ State _____

ELECTRONICS IS HIGHER INCOME!
Prepare NOW! EARN YOUR A. S. DEGREE IN 24 MOS.

DEMAND FOR ELECTRONIC ENGINEERING TECHNOLOGISTS EXCEEDS SUPPLY! Enroll with a nationally-recognized leader in electronics education. ECPD Accredited Technical Institute curricula in Electronic Engineering Technology and Commercial Broadcast Technology. Complete career preparation for booming fields of ELECTRONICS—COMMUNICATIONS—BROADCASTING—COMPUTER TECHNOLOGY—COMPUTER PROGRAMMING. College level resident and home-study courses. Coeducational. Up-to-date laboratories feature IBM, BENDIX and UNIVAC electronic computers and data processing equipment. SEND COUPON FOR COMPLETE CATALOG.

CENTRAL TECHNICAL INSTITUTE 1544 Wyandotte, Kansas City 8, Mo. RE63

Name _____ Age _____
Address _____
City _____ Zone _____ State _____
CHECK INTEREST: Resident Home Study

Home Study Courses in COMPUTER LOGIC COMPUTER PROGRAMMING TRANSISTOR PRINCIPLES from the PHILCO TECH CENTER

Study at home in your spare time and at your own pace. Choose from these courses:

1. Digital Computer Fundamentals. An up-to-date Introduction to the logical construction of a computer, its design, operation and application.
2. Programming for Digital Computers. An introduction to the basic concepts and techniques of programming. Topics include number systems, flow charting, coding, debugging and program systems for the future.
3. Transistor Principles and Practice. A comprehensive course for experienced electronics technicians and engineers. Experiments verify theory and design. Pulse and special circuits are included.

MAIL COUPON FOR FREE INFORMATION

PHILCO TECHNOLOGICAL CENTER
P.O. Box 4730, PHILADELPHIA 34, PENNA.

Please send information on the home study courses I have checked below.

Digital Computer Fundamentals, Programming for Digital Computers, Transistor Principles and Practices, Other

Name _____ Age _____
Occupation _____
Address _____
City _____ Zone _____ State _____

PHILCO
A SUBSIDIARY OF Ford Motor Company

JUMBO POLY PAK OFFER

FREE! FREE! EXCLUSIVE **FREE! FREE! Only with Poly Paks**

\$25 PLUS \$100

JUMBO PAK

- Transistors
- Diodes
- Rectifiers
- Coils
- Resistors
- Knobs
- Condensers
- Etc. Etc.

25c for handling

CHOOSE ANY ITEM IN THIS SALE AD FREE WITH EVERY \$10.00 ORDER!

BOTH FREE WITH ANY \$10.00 ORDER

SEMI-KON-DUCTORS by POLY PAK

We Bought Up Millions—No Chance to Test 'Em!

- 15 SILICON DIODES, up to 750 ma, epoxy & gold. \$1
- 20 TOP HAT RECTIFIERS, to 750 ma silicon. \$1
- 10 ZENER DIODES, gold-n-silver plated. \$1
- 15 PNP TRANSISTORS, assorted styles. \$1
- 15 NPN TRANSISTORS, assorted styles. \$1
- 10 2-AMP POWER RECTIFIERS, silicon, stud. \$1
- 5 POWER TRANSISTORS, 2N155, TO3 style case. \$1
- 20-AMP POWER RECTIFIER, silicon, stud. \$1

FACTORY TESTED SEMI-KONS by POLY PAK

- 5 RF TRANSISTORS, PNP, osc, 5 mcs, 2N377. \$1
- 10 TRANSISTORS, 5 PNP, 5 NPN, assorted types. \$1
- 3 20-WATT TRANS., stud, 2N1323, TO10 case. \$1
- 4 SELENIUM RECTIFIER, 100 ma, 115 vac. \$1
- 10 HIGH GAIN NPN TRANSISTORS, 705 case. \$1
- HOFFMAN SOLAR SILICON CELL, 1/2" x 1". \$1
- 2-AMP SILICON CONTROLLED RECT., 2N1600 stud. \$1
- 3 HUGHES H.V. PLUG-IN TWIN RECT., 7-pin. \$1
- 15 1N34 GERMANIUM DIODES, subminiature size. \$1
- 4 2N107 TRANSISTORS, PNP, standard make. \$1
- 4 2N35 TRANSISTORS, NPN, standard make. \$1
- 4 2N170 type TRANSISTORS, NPN, RF-osc. \$1
- 4 SUN BATTERIES, to 1 1/2", lite sens. projects. \$1
- 25-amp TRANSISTOR, car ignition, TO3. \$1
- 1-WATT ZENER REGULATORS, choose from 3 to 30V. \$1
- 60-pc SET: transistors, diodes, resistors, etc. \$1
- 6 750-MA 600V TOP HAT RECTIFIERS. \$1
- 25 PLUG-IN DIODES, 1N119, 1N82. \$1
- 10 PNP TRANSISTORS, printed circuit radios. \$1
- 4 GP 2N43 PNP TRANSISTORS. \$1
- 4 WORLD'S SMALLEST TRANSISTORS, npn. \$1

POLY PAK KIT OF THE MONTH

25-pc. SEMICONDUCTOR "Bank" \$1

Incl.: PNP, NPN, Power TRANSISTORS; Top Hat, Epoxy RECTIFIERS; Germanium, Silicon DIODES; Zener REGULATORS; Power Stud RECTIFIERS; Sun Battery.

WORLD FAMOUS DOLLAR POLY PAKS

- 25 'CERAFIL' WORLD'S SMALLEST COND., to .05 mf \$1
- 3 TRANS'N TRANSFORMERS, input-driver-output. \$1
- 2 FILTER CHOKES, 10 henry, 100ma, strap mtg. \$1
- 2 WORLD'S SMALLEST 456KCS IFs, 3/4" square. \$1
- 2 TRANSISTOR VOL. CONTROLS, 5000 ohm, w/sw. \$1
- 20 SQUARE 'DISK' CONDENSERS, .01 to .05 mf. \$1
- 2N155 TRANSISTOR OUTPUT TRANSFORMER, to 3.2 \$1
- TRANSISTOR PM SPEAKER, 2 3/4" dia, 3.2 v.c. \$1
- 20 'CORNING' RESISTORS, 3 to 7W to 24K ohms. \$1
- 40 WORLD'S SMALLEST RESISTORS, 5% too. \$1
- 4 TRANSISTOR TRANSFORMERS, printed circuits. \$1
- 85 PRINTED CIRCUIT RADIO PARTS, worth \$60. \$1
- 60 CERAMIC CONDENSERS, asst values. \$1
- 30 SILVER MICA CONDENSERS, asst values. \$1
- 50 TERMINAL STRIPS, asst types, makes. \$1
- 15 RCA PLUG & JACK SETS, tuners, amplifiers. \$1
- 60 HI-Q RESISTORS, 1/2, 1, 2W to 1-meg, 5% too. \$1
- 100 ASST HALF WATERS, resistors, 5% too. \$1
- 30 TWO WATERS, resistors, AB, 5% too. \$1
- 50 COILS & CHOKES, rf, osc, peaking, IF too. \$1
- \$25 RADIO-n-TV SURPRISE, wide variety. \$1
- 10 TRANSISTOR ELECTROLYTICS, asst values. \$1
- 50 RADIO-n-TV KNOBS, asst colors, styles. \$1
- 10 ELECTROLYTICS, can & tubular types. \$1
- 10 VOLUME CONTROLS, to 1-meg, switch too. \$1
- 50 MICA CONDENSERS, to .01, silvers too. \$1
- 10 TOGGLE SWITCHES, asst types, makes. \$1
- 20 POWER RESISTORS, w.w., 3-50w to 24K. \$1
- 10 TRANSISTOR SOCKETS, for PNP-NPNs. \$1
- 10 PANEL SWITCHES, rotary, toggle, micro. \$1
- 3 FERRITE ANTENNAS, 540-10 1600 kc, 4 1/2" long. \$1
- 60 TUBE SOCKETS, plugs, receptacles. \$1
- 40 DISC CONDENSERS, to .05 to 6KV, 20 values. \$1
- 60 TUBULAR CONDENSERS, to .5mf to 1500V. \$1
- 1500-pc. HARDWARE KIT, radio-n-tv screws, etc. \$1
- 50 ALLEN BRADLEY 1 WATERS, 5% too. \$1
- 300-ft. HOOKUP WIRE, asst colors, sizes. \$1
- 30 'LOW NOISE' CORNING RESISTORS, 5% too. \$1
- 30 PRECISIONS, 1/2 & 1%, to 1-meg, 1/2, 1, 2W. \$1
- 150-ft. TRANSISTOR WIRE, #26-#32 sizes. \$1
- 2 TRANS. SUPERHET VARIABLE COND., w/cal. dial. \$1
- 100 TUBULAR CERAMIC CONDENSERS. \$1

SEND 10¢ FOR BARGAIN MAIL-ORDER FLYERS

Semiconductors Poly Paks Parts

POLY PAKS

TERMS: Send check, money order, incl postage—avg wt per pak 1 lb. Rated firms, net 30 days. EXPORT ORDERS INVITED.

P.O. Box 942R, So. Lynnfield, Mass.

World's largest supplier of pre-packed assortments

ADVERTISING INDEX

Allied Radio Corp.	98	Multicore (Div. of British Industries)	101
Antenna Specialists Co.	12	National Radio Institute	3, 92
Arco Electronic Supply Co. (Arcolytic Div.)	8	National Technical Schools	5
ATR Electronics, Inc.	16	North American Philips Co. Inc. (Norelco)	20
B & K Manufacturing Co.	77	Polypaks	104
Blonder-Tongue Labs	18	Progressive Edu-Kits Inc.	86
Britannica Schools (Div. of Encyclopaedia Britannica Press, Inc.)	89	RCA (Tube Div.)	Back Cover
Brooks Radio & TV Corp.	87	RCA (Citizens Band Div.)	83
Capitol Radio Engineering Institute	17	RCA (Communications Tube Campaign)	81
Carston	98	RCA (Test Equipment Div.)	85
Castle TV Tuner Service	101	RCA Institutes	54-57
CLASSIFIED ADS	100-101	Rad-Tel Tube Co.	83
Cleveland Institute of Electronics	11	Radio Research Instrument Co.	92
Colordaptor	63	Relco	92
Cornell Electronics Co.	94	(J. F.) Rider Publisher Co., Inc.	99
Coyne Electrical School	62, 96	Rohn Manufacturing Co.	93
Coyne School Publications	73	(H. W.) Sams & Co., Inc.	19, 95
DeVry Technical Institute	7	Saxitone Tape Sales (Div. of Commissioned Electronics)	104
Dressner	98	Schober Organ Co.	62
Editors & Engineers	80	(H. H.) Scott, Inc.	80
EICO Electronic Instrument Co.	22	Semtronics	97
Electro-Voice Inc.	9	Sencore	59
Electronic Chemical Corp.	94	Sonotone Corp.	91
Electronic Measurement Corp. (EMC)	68	Sprague	75
Electronic Publishing Co., Inc.	80	Stancor Electronics Inc.	90
Eurotech	92	Surface Conductor, Inc.	62
Fair Radio Sales	92	S. W. Index	104
GM Photoelectronics	63	Sylvania Electric Products Inc.	60-61
General Electric (Receiving Tube Div.)	13	(Sarkes) Tarzian Inc. (Tape Div.)	76
Gernsback Library	79, 92, 102	(Sarkes) Tarzian Inc. (Tuner Div.)	63
Grantham School of Electronics	15	Triplet Electrical Instrument Co.	2nd Cover
Harman-Kardon Inc.	14	University Loudspeakers Inc.	21
Heald's Engineering College	98	Warren Electronics Co.	98
Heath Company	71	Winegard Co.	64-65
International Crystal Mfg. Co. Inc.	69	Workman Electronic Products Inc.	97
International Electronics Sales Corp.	58	Wuerth Products Corp.	96
ITT—Federal Electric Corp.	3rd Cover		
Jerrold Electronics Co. (Subsidiary of Jerrold Corp.)	10		
(E. F.) Johnson Co.	88		
Key Electronics Co.	98		
Lafayette Radio	94		
(P. R.) Mallory Co., Inc.	67		
Mercury TV Tuner Service	93		
Moss Electronic Inc.	88		

SCHOOL DIRECTORY page 103

- Central Technical Institute
- Electronic Technical Institute
- Indiana Institute of Technology
- International Correspondence Schools
- Northrop Institute of Technology
- Pacific International College of Arts & Sciences
- Philco Corp. (Technological Center)
- Tri-State College
- Valparaiso Technical Institute

Printed in USA.

SW INDEX

A complete 2 in 1 fact file for Professional and Amateur SWLs. The World of Short Wave Radio at your fingertips.

I. WORLDWIDE FILE

By hour of the day, English Language Transmissions to all parts of the World. 1,500 hours of Programming a week—190 daily Newscasts: Lists Country/Service—Frequencies—Time of Newscasts—Area Beamed.

II. NORTHAMERICAN SERVICES FILE

By country or service—Lists time of English Language Transmissions, Frequencies—Program Descriptions (including DX, Mailbag, News etc.)—Addresses of Services.

SW Index is ideal for note or log keeping. The Complete, Professional Guide to Short Wave Listening!

\$1 Postpaid

SW INDEX

Dept R, Box 30 New York 34, N.Y.

SAXITONE RECORDING TAPE

*Oxide guaranteed not to rub off or squeak—or money back. Compare ours with other "Bargain" tape. You'll find it's more than just "price" when you deal with us. We are original pioneers in the tape recorder business and our reputation means everything to us.

- 225' MYLAR, 3" (in mailable box) .39
- 600' acetate (plastic), 5 inch. .75
- 600' MYLAR 5 inch reel. .85
- 900' MYLAR (Polyester), 5 inch. .89
- 1200' MYLAR, 1/2 mil, 5 inch reel. 1.18
- 1200' MYLAR, tensitized, 5 inch. 1.59
- 1200' acetate (plastic), 7 inch. 1.15
- 1200' MYLAR, 1 1/2 mil. (strong) 1.29
- 1800' acetate (plastic), 7 inch. 1.39
- 1800' MYLAR 1 mil. thick, 7 inch. 1.89
- 2400' MYLAR, untensitized, 7 inch. 2.59
- 2400' MYLAR, tensitized, 7 inch. 2.89

(Large Users Even Lower)

SAVE 30% 4-track stereo music on tape

PLUS POSTAGE

NORELCO SPEAKERS

Famous AD3800M, twin cone 8" (75-19,000 cycles) comparable net 9.90 now 4.95, 2 for 9.00, plus postage. OTHER Norelco models at BIG DISCOUNTS. Specifications on entire Norelco line sent on request.

SAXITONE TAPE SALES

div. Commission Electronics, Inc.
1776 Columbia Rd., Wash., D.C.

ADVERTISE IN THE CLASSIFIED AD SECTION OF RADIO-ELECTRONICS

55c per word. (10-word minimum). 10% discount on 3 or more insertions.

Send your copy and your check to:

RADIO-ELECTRONICS
154 W. 14th Street, New York 11, N. Y.

WORLD-WIDE ENGINEERING ASSIGNMENTS WITH ITT-FEDERAL ELECTRIC CORPORATION

Working in more than 30 countries across the free world, electronics technicians and engineers of ITT-Federal Electric Corporation install, service, maintain and manage an immense variety of electronic equipment and systems. These range from the 4,000 mile DEW Line across the frozen North, to the single instrumentation site on a lonely promontory jutting into the Ocean, down the Pacific Missile Range.

But between these extremes, there's much more — not only in terms of individual challenge and adventure, but in importance to the growth and welfare of other friendly nations. An example here is the

microwave communications network linking 8 cities in South Vietnam.

Actually, at any point in time, FEC engineers and technicians are working on more than 100 active projects — installing, testing or operating almost every type of wire or wireless communication system in addition to radar, instrumentation and computer facilities, plus the multitude of ancillary systems and services supporting them.

The great number and diversity of our programs generates these valuable career advantages rarely found together in service engineering today:

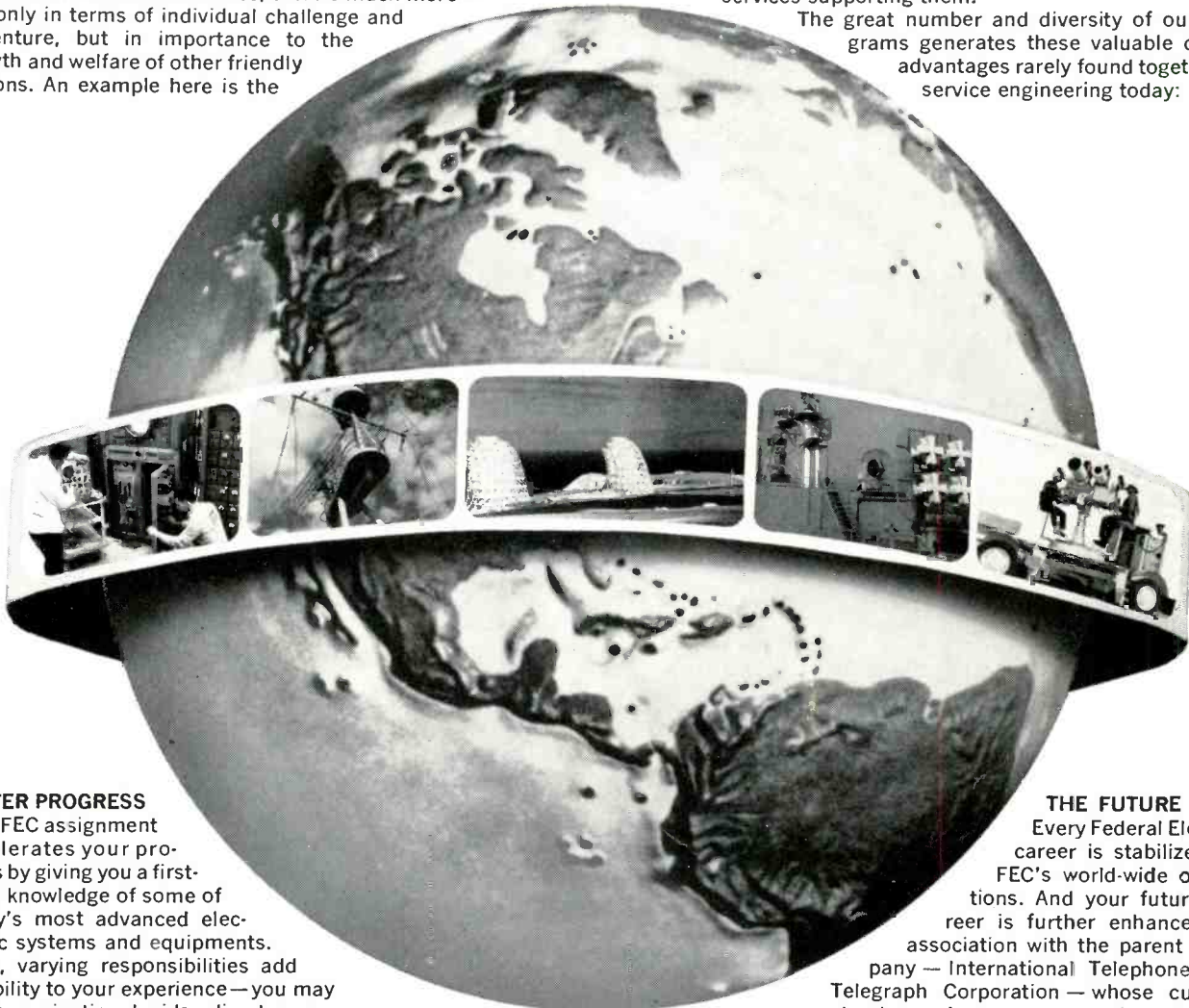

FASTER PROGRESS

Your FEC assignment accelerates your progress by giving you a first-hand knowledge of some of today's most advanced electronic systems and equipments. Then, varying responsibilities add flexibility to your experience—you may teach navigational aids, direct emergency maintenance, supervise a radar installation, or become a field service administrator. And to help you forward faster, FEC reimburses you 100% for advanced study at leading universities and colleges or approved technical correspondence courses you complete.

ADVENTURE

An assignment may take you to Nepal — or to Africa, Alaska, Greenland, Europe, Canada or across the U.S. FEC field engineering operates in almost every climate and living condition in the world. Along with adventurous assignments in exotic countries, FEC field work often has a diplomatic side. For instance, teaching native workmen how to operate systems you're helping to install — a first-hand role in strengthening the good impression of our country by making friends abroad.

THE FUTURE

Every Federal Electric career is stabilized by FEC's world-wide operations. And your future career is further enhanced by association with the parent company — International Telephone and Telegraph Corporation — whose current annual sales and revenues now exceed a billion dollars. When a field job is completed, FEC men have priority for openings in other field assignments, as well as at headquarters in Paramus, New Jersey. Then too, you may find a future with one of the many subsidiaries and divisions of ITT who also seek qualified technical talent.

There are always interesting positions at many levels with FEC. However, openings change from day to day. If you would like to receive further information on current opportunities, please write to: Mr. A. Sheridan, ITT — Federal Electric Corp. Room 89-MJ, Paramus Industrial Park, Paramus, N. J.

ITT FEDERAL ELECTRIC CORPORATION

An Equal Opportunity Employer



KEEPING SILVERAMA'S MATCHLESS COMPLEXION

Critical inspections assure highest quality screen for RCA picture tubes

Because your customers judge a picture tube by its face, RCA makes certain that every Silverama® picture tube has a matchless complexion. Super-critical inspections at various stages of manufacture assure the virtually blemish-free television viewing surface your customers expect in an RCA Silverama.

At the screen inspection station in our Marion, Indiana picture tube plant (above), for example, an inspector uses transmitted light to check for pin-holes and other flaws in

newly applied phosphor screens. The most minute imperfection—even the slightest variation in screen texture, color or smoothness—is cause for rejection of the bulb.

Screen inspections using both ultra-violet and transmitted light are but one phase of the exhaustive battery of visual, mechanical, and electrical quality control tests each Silverama must pass. The object: to maintain a product you can recommend and install with confidence in your customers' TV sets.

Envelope inspection. Picture tube envelopes are polished, and given a series of acid baths prior to re-use that delicately etch the interior of the glass to restore it to the peak of its optical capability. Then they are thoroughly inspected to meet the standards of the original new envelope.



Screen inspection. Every completed Silverama is re-inspected for screen quality and sharpness of focus at this special automatic testing station near the end of the production cycle. Each Silverama undergoes as many as 26 inspections before it is released for sale to your customers.

RCA ELECTRON TUBE DIVISION, HARRISON, N. J.



The Most Trusted Name in Television